

NEUES PROGRAMM NEW PROGRAMME

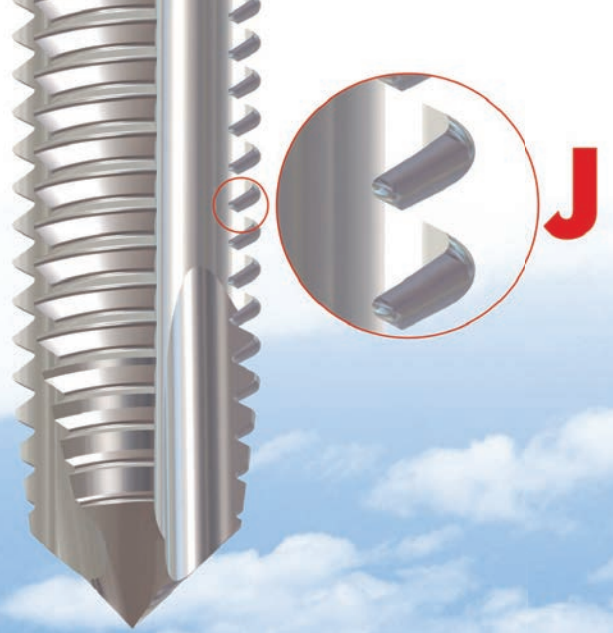

AERO

Gewindewerkzeuge für Luft- und Raumfahrtmaterialien
Threading tools for aerospace materials



DE-EN-ID



VERFÜGBARKEIT DER ARTIKEL

- ID Lagerartikel
- ID Kurzfristig lieferbar

AVAILABILITY OF THE ARTICLES

- ID Stock item
- ID Available at short notice



ANWENDUNGSGRUPPEN

Beispiele für Anwendungsgruppen

13 Kohlenstoffstahl 1.0503 C45 1.0535 C55 1.0601 C60 1.1545 C105W1 1.2067 102Cr6 (100Cr6)	15 Stahl legiert / vergütet > 850 - < 1150 N/mm² 1.3553 X82WMoCrV6-5-4 1.6580 30CrNiMo8 1.7220 34CrMo4 1.7225 42CrMo4 1.8507 34CrAlMo5	16 Hochfester Stahl ≤ 44 HRC EN-GJS-1200-2 1.6582 34CrNiMo6v 1.7225 42CrMo4v 1.7228 50CrMo4v 1.8515 31CrMo12v	22 Austenitisch 1.4301 X5CrNi18-10 1.4406 X2CrNiMoN17-12-2 1.4435 X2CrNiMo18-14-3 1.4541 X6CrNiTi18-10 1.4571 X6CrNiMoTi17-12-2	23 Ferritisch, martensitisch < 850 N/mm² 1.4112 X90CrMoV18 1.4540 X4CrNiCuNb16-4 1.4582 X4CrNiMoNb25-7 1.4762 X10CrAl24 1.4922 X20CrMoV11-1
24 Ferritisch, martensitisch > 850 - < 1150 N/mm² 1.4057 17CrNi16-2 1.4125 X105CrMo17 1.4542 X5CrNiCuNb16-4 1.4548 X5CrNiCuNb17-4-4 1.4748 X85CrMoV18-2	41 Reintitan 3.7024 Grad1 3.7034 Grad2 3.7055 Grad3 3.7065 Grad4	42 Titanlegierung 3.7124 TiCu2.5 Ti6Al7Nb 3.7164 TiAl6V4 (Grad5) 3.7174 TiAl6V6Sn2	51 Nickellegierung 1 ≤ 850 N/mm² 1.3912 Ni36 (Invar) 2.4360 NiCu30Fe (Monel 400) 2.4816 NiCr15Fe (Inconel 600) 1.4876 X10NiCrAlTi32-20	52 Nickellegierung 2 > 850 - ≤ 1150 N/mm² 2.4375 NiCu30Al (MonelK500) 2.4631 NiCr20TiAl (Nimonic 80) 2.4668 NiCr19NbMo (Inconel718)
53 Nickellegierung 3 > 1150 - ≤ 1600 N/mm² 2.4631 NiCr20TiAl (Nimonic80) 2.4668 NiCr19NbMo (Inconel718)	61 Reinkupfer (Elektrolytkupfer) 2.0060 E-Cu57 (E-Cu)	64 Messing bleifrei CuZn21Si3P (ECOBRASS®) CuZn35 CuZn42	Referenz: DIN	

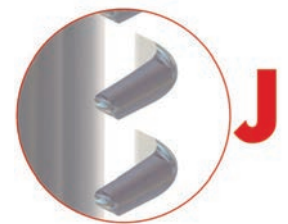

AEROSPACE-GEWINDENORMEN

ISO 3161 / ISO 5855 mit Radius

Die Normen ISO 3161, UNJ, und ISO 5855, MJ, befassen sich mit der Konstruktion von Luft- und Raumfahrtgewinden. Sie definieren die allgemeinen Abmessungen, die zu verwendenden Toleranzen und die Radiusanforderungen für die Konstruktion der Profile. Diese Normen schreiben vor, dass das Radiusprofil am Aussendurchmesser nicht kleiner als das Grundprofil sein darf und an keiner Stelle den zulässigen Aussendurchmesser überschreiten darf. Die Normen schreiben jedoch keinen bestimmten Radius vor. Die Konstruktion unserer Gewindebohrer basiert auf den erforderlichen Toleranzen UNJ in 3B und MJ in 4H. Die Bezeichnung unterliegt einer strengen Regel, gemäss welcher die Steigung immer erwähnt werden muss.

ISO 5855 MJ 6x1 4H5H: Toleranz des Flanken-Ø gefolgt von der Toleranz des Innen-Ø.

ISO 3161 0.2500-20 UNJC: auch akzeptiert mit UNJC 1/4-20 3B

SPEZIFIKATIONEN

Beim Gewindeschneidwerkzeug **bleibt der Flankendurchmesser zwar gleich, aber der abgerundete Gewindekamm vermeidet scharfe Winkel, die zu Brüchen im Werkstück führen könnten.**



Composites
GWi3067VX

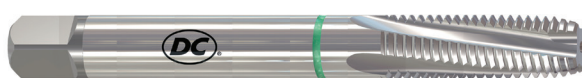

Super alloys
SA390-3



Titanium alloys
TL351VS-3

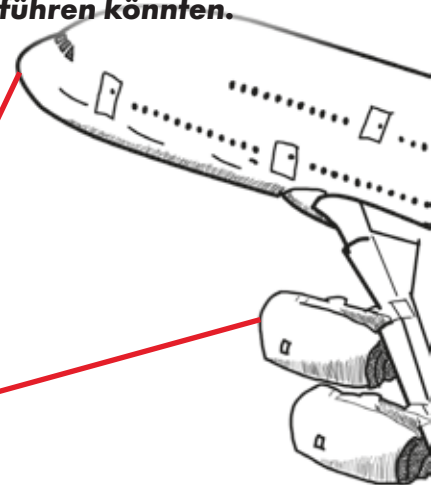

APPLICATION GROUPS

Examples for application groups

13 Carbon steels 1.0503 C45 1.0535 C55 1.0601 C60 1.1545 C105W1 1.2067 102Cr6 (100Cr6)	15 Alloy steels hard./temp. > 850 - < 1150 N/mm ² 1.3553 X82WMoCrV6-5-4 1.6580 30CrNiMo8 1.7220 34CrMo4 1.7225 42CrMo4 1.8507 34CrAlMo5	16 High tensile alloy steels ≤ 44 HRC EN-GJS-1200-2 1.6582 34CrNiMo6v 1.7225 42CrMo4v 1.7228 50CrMo4v 1.8515 31CrMo12v	22 Austenitic stainless steels 1.4301 X5CrNi18-10 1.4406 X2CrNiMoN17-12-2 1.4435 X2CrNiMo18-14-3 1.4541 X6CrNiTi18-10 1.4571 X6CrNiMoTi17-12-2	23 Ferritic and martensitic < 850 N/mm ² 1.4112 X90CrMoV18 1.4540 X4CrNiCuNb16-4 1.4582 X4CrNiMoNb25-7 1.4762 X10CrAl24 1.4922 X20CrMoV11-1
24 Ferritic and martensitic > 850 - < 1150 N/mm ² 1.4057 17CrNi16-2 1.4125 X105CrMo17 1.4542 X5CrNiCuNb16-4 1.4548 X5CrNiCuNb17-4-4 1.4748 X85CrMoV18-2	41 Pure titanium 3.7024 Grad1 3.7034 Grad2 3.7055 Grad3 3.7065 Grad4	42 Titanium alloys 3.7124 TiCu2.5 Ti6Al7Nb 3.7164 TiAl6V4 (Grad5) 3.7174 TiAl6V6Sn2	51 Nickel alloys 1 ≤ 850 N/mm ² 1.3912 Ni36 (Invar) 2.4360 NiCu30Fe (Monel 400) 2.4816 NiCr15Fe (Inconel 600) 1.4876 X10NiCrAlTi32-20	52 Nickel alloys 2 > 850 - ≤ 1150 N/mm ² 2.4375 NiCu30Al (MonelK500) 2.4631 NiCr20TiAl (Nimonic 80) 2.4668 NiCr19NbMo (Inconel718)
53 Nickel alloys 3 > 1150 - ≤ 1600 N/mm ² 2.4631 NiCr20TiAl (Nimonic80) 2.4668 NiCr19NbMo (Inconel718)	61 Pure copper (electrolytic copper) 2.0060 E-Cu57 (E-Cu)	64 Lead free brass CuZn21Si3P (ECOBRASS®) CuZn35 CuZn42	Reference: DIN	

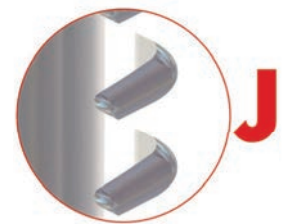

AEROSPACE THREAD NORMS

ISO 3161 / ISO 5855 with radius

The norms ISO 3161, UNJ, and ISO 5855, MJ, refer to the construction of aerospace threads. They define the general dimensions, the tolerances to be used and the radius requirements for the construction of the profiles. These norms specify that the radius profile at the external diameter must not be smaller than the basic profile or exceed the permitted external diameter at any point. However, the standards do not specify any particular radius. The construction of our taps is based on the required tolerances UNJ in 3B and MJ in 4H. The designation is subject to a strict rule according to which the pitch must always be mentioned.

ISO 5855 MJ 6x1 4H5H: Tolerance of the flank \varnothing followed by the tolerance of the internal \varnothing .

ISO 3161 0.2500-20 UNJC: also accepted with UNJC 1/4-20 3B

SPECIFICATIONS

On the threading tool, **while the flank diameter remains the same, the rounded thread crest avoids any sharp angles that could lead to breakage in the workpiece.**

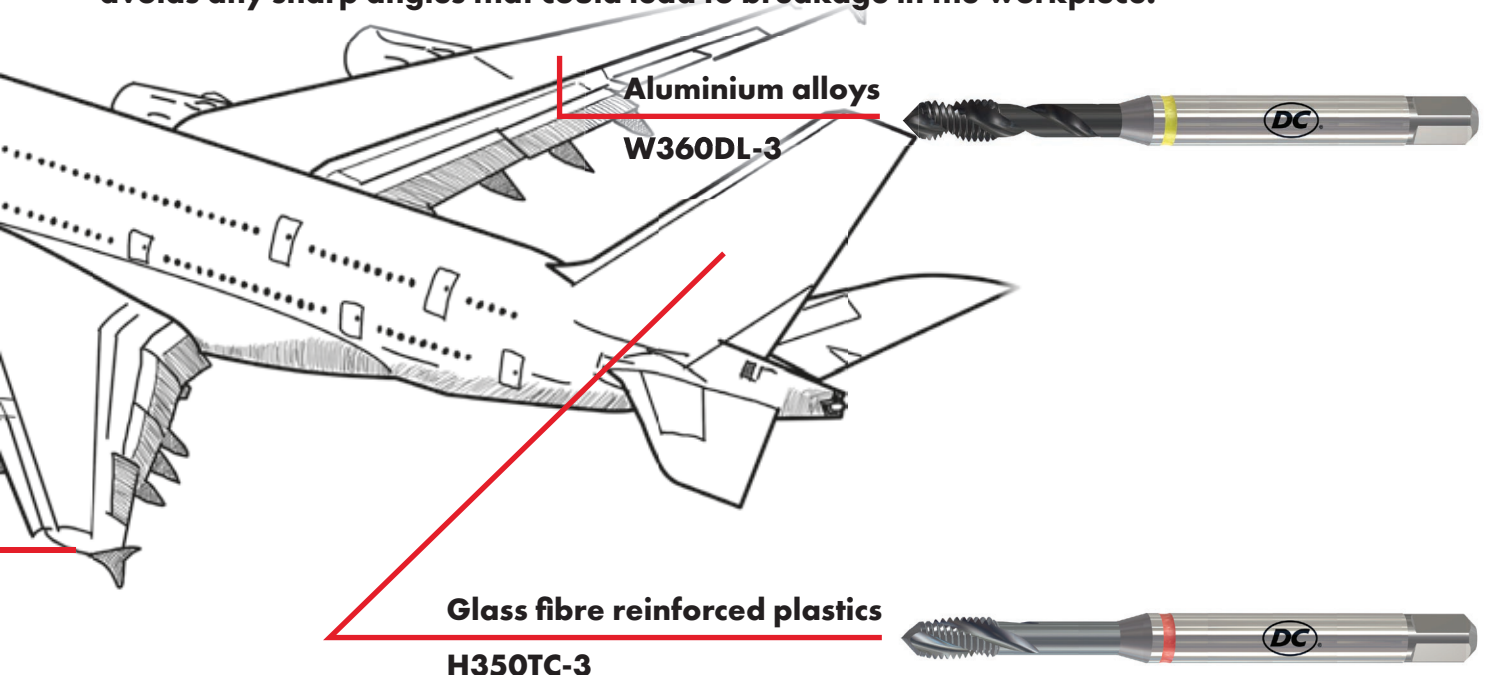

ANWENDUNGSTABELLE — APPLICATION CHART

**Gewindeschneiden
Thread cutting**

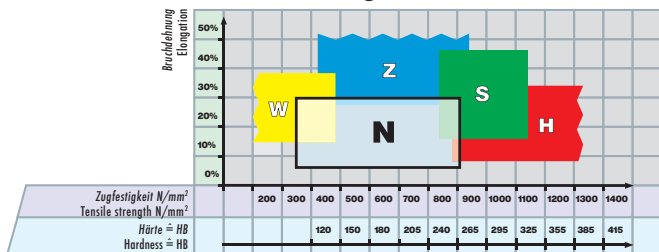

**Gewindeschneiden
Thread cutting**

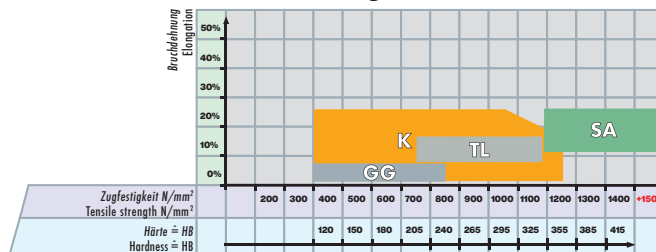

DC -Anwendungsgruppen

DC Material classification













Werkstoff-Gruppen Material groups	Werkstoffbezeichnung	Material designation	Härte Hardness (HB)	Festigkeit Tensile strength Rm (N/mm ²)	Dehnung Elongation A (%)
10 Stahl Steels	11 Automatenstahl	Free-cutting steels	< 200	< 700	< 10
	12 Baustahl, Einsatzstahl	Structural, cementation steels	< 200	< 700	< 30
	13 Kohlenstoffstahl	Carbon steels	< 300	< 1000	< 20
	14 Stahl legiert < 850 N/mm ²	Alloy steels < 850 N/mm ²	< 250	< 850	< 30
	15 Stahl legiert / vergütet > 850 - < 1150 N/mm ²	Alloy steels hard. / temp. > 850 - < 1150 N/mm ²	> 250	> 850	< 30
	16 Hochfester Stahl ≤ 44 HRC	High tensile alloy steels ≤ 44 HRC	> 250	> 850	< 12
	17 Stahl vergütet > 44 - ≤ 54 HRC	Alloy steels tempered > 44 - ≤ 54 HRC	> 410	> 1400	< 2
	18 Stahl gehärtet > 54 - ≤ 63 HRC	Alloy steels hardened > 54 - ≤ 63 HRC	> 560	> 1980	< 2
20 Rostfreier Stahl Stainless steels	21 Rostfreier Stahl, geschwefelt	Free machining stainless steels	< 250	< 850	< 25
	22 Austenitisch	Austenitic stainless steels	< 250	< 850	> 20
	23 Ferritisch, martensitisch < 850 N/mm ²	Ferritic and martensitic < 850 N/mm ²	< 250	< 850	> 20
	24 Ferritisch, martensitisch > 850 - < 1150 N/mm ²	Ferritic and martensitic > 850 - < 1150 N/mm ²	> 250	> 850	> 15
30 Guss Cast iron	31 Grauguss	Cast iron	< 250	< 850	< 10
	32 Kugelgraphitguss, Temporguss	Spheroidal graphite + malleable cast iron	< 250	< 850	> 10
40 Titan Titanium	41 Reintitan	Pure titanium	< 250	< 850	> 20
	42 Titanlegierung	Titanium alloys	> 250	> 850	< 20
50 Nickel Nickel	51 Nickellegierung 1 ≤ 850 N/mm ²	Nickel alloys 1 ≤ 850 N/mm ²	< 250	< 850	> 25
	52 Nickellegierung 2 > 850 - ≤ 1150 N/mm ²	Nickel alloys 2 > 850 - ≤ 1150 N/mm ²	> 250	> 850	< 25
	53 Nickellegierung 3 > 1150 - ≤ 1600 N/mm ²	Nickel alloys 3 > 1150 - ≤ 1600 N/mm ²	> 340	> 1150	< 20
60 Kupfer Copper	61 Reinkupfer (Elektrolytkupfer)	Pure copper (electrolytic copper)	< 120	< 400	> 12
	62 Messing, Bronze, Rotguss (kurzspanend)	Short chip brass, phosphor bronze, gun metal	< 200	< 700	< 12
	63 Messing (langspanend)	Long chip brass	< 200	< 700	> 12
	64 Messing bleifrei	Lead free brass	< 220	< 700	> 15
70 Aluminium Magnesium Aluminium Magnesium	71 Al unlegiert	Al unalloyed	< 100	< 350	> 15
	72 Al legiert Si < 1.5 %	Al alloyed Si < 1.5 %	< 150	< 500	> 15
	73 Al legiert Si > 1.5 % - < 10 %	Al alloyed Si > 1.5 % - < 10 %	< 120	< 400	< 15
	74 Al legiert Si > 10 %, Mg-Legierungen	Al alloyed Si > 10 %, Mg-alloys	< 120	< 400	< 10
80 Kunststoff Plastic compounds	81 Thermoplaste	Thermoplastics	-	-	-
	82 Duroplaste	Duroplastics	-	-	-
	83 Faserverstärkte Kunststoffe	Glass fibre reinforced plastics	-	-	-
90 Edelmetalle Precious metals	91 Gelbgold	Yellow gold	-	-	-
	92 Rotgold	Red gold	-	-	-
	93 Weissgold	White gold	-	-	-
	94 Silber	Silver	-	-	-

Optimal mit Schneidöl
Optimal with cutting oil

Geeignet mit Schneidöl
Suitable with cutting oil

Optimal mit Emulsion
Optimal with emulsion

Geeignet mit Emulsion
Suitable with emulsion

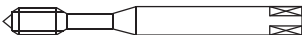
		S		SA			
Merkmale Characteristics		 VS	 R45  VX	 R15			
		 NEW	 NEW	 NEW	 NEW		
Lochart Hole type							
		S320VS-4	S370VX-3	SA320-4	SA350-3		
MJ 4H6H / 4H5H	ISO 5855	DIN lang DIN long	DIN 371	8	8	9	9
UNJC 3B	ISO 3161/ASME B1.15	DIN lang DIN long	DIN 371	10	10	11	11
UNJF 3B	ISO 3161/ASME B1.15	DIN lang DIN long	DIN 371	12	12	13	13

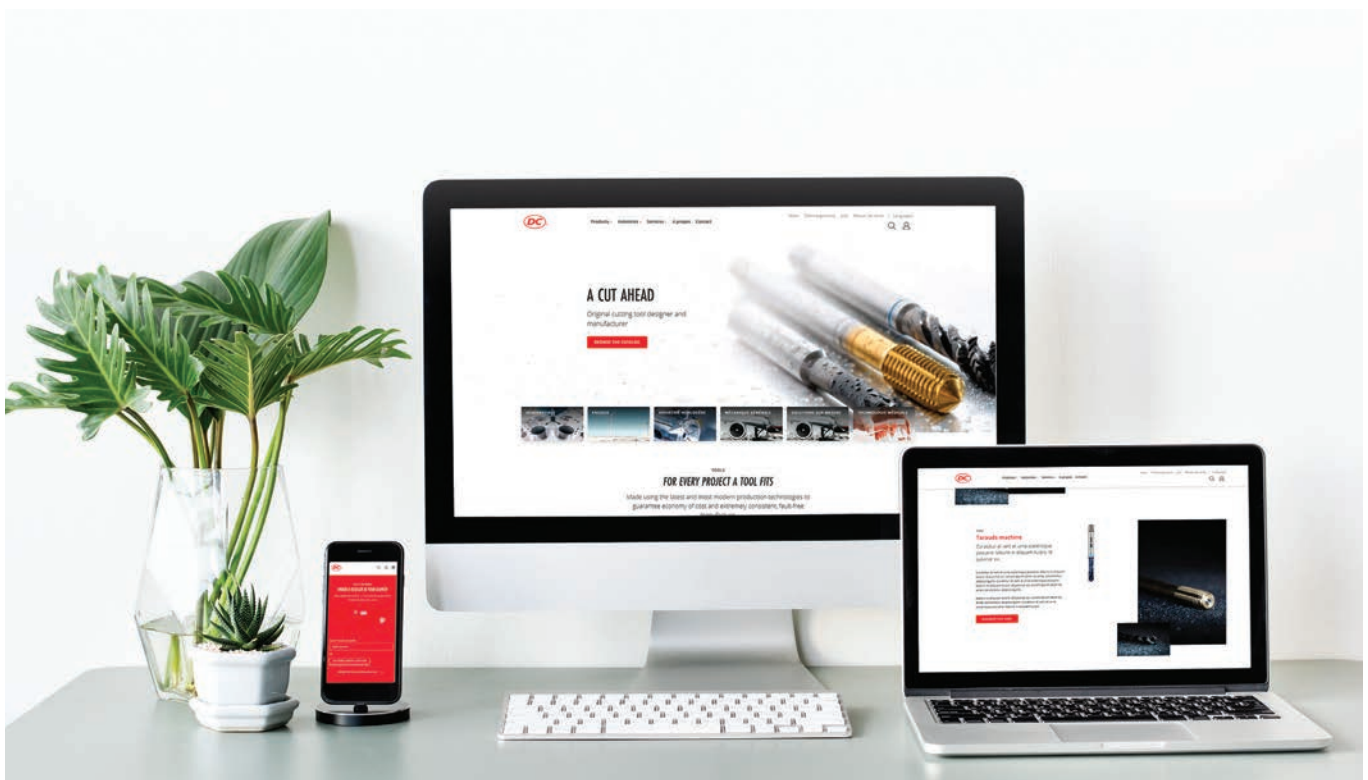

MJ, UNJC, UNJF

Inhaltsverzeichnis — Maschinengewindebohrer MJ ISO 5855,
UNJC / UNJF ISO 3161/ASME B1.15

Directory — Machine taps MJ ISO 5855, UNJC / UNJF ISO 3161/ASME B1.15

SA	TL
 R10	 R15  VS
 NEW	 NEW
	
SA390-3	TL351VS-3
8	9
10	11
12	13



NEUE WEBSITE
IM AUFBAU

NEW WEBSITE
UNDER CONSTRUCTION

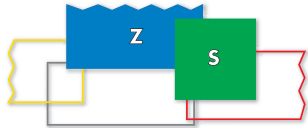
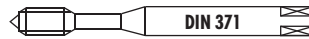

S320VS-4



VS

13 15 16 22
23 24 52

S370VX-3



VX



15 22 23 24
51 52 61

aero

SA390-3



16 53

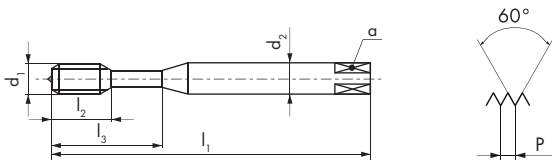

S320VS-4

S370VX-3

SA390-3



NEW

NEW

NEW



≤ 2.5 x D

< 1.5 x D



< 1.5 x D



4H5H

4H5H

4H5H

Ø d ₁ MJ	P mm	l ₁ mm	l ₂ mm	l ₃ mm	d ₂ mm	a mm			ID
3	0.5	56	12	18	3.5	2.7	3	2.55	● 198966
4	0.7	63	14	21	4.5	3.4	3	3.4	● 198967
5	0.8	70	15	25	6	4.9	3	4.3	● 198968
6	1	80	17	30	6	4.9	3	5.1	● 198969
8	1	90	20	35	8	6.2	3	7.1	● 198970
8	1.25	90	20	35	8	6.2	3	6.9	● 198971
10	1.25	100	22	39	10	8	3	8.9	● 198972
10	1.5	100	22	39	10	8	3	8.6	● 198973
Ø d ₁ MJ	P mm	l ₁ mm	l ₂ mm	l ₃ mm	d ₂ h6 mm	a mm			ID
3	0.5	56	5.5	18	3.5(h9)	2.7	3	2.55	● 198974
4	0.7	63	7.5	21	4.5(h9)	3.4	3	3.4	● 198975
5	0.8	70	9	25	6	4.9	3	4.3	● 198976
6	1	80	11	30	6	4.9	3	5.1	● 198977
8	1	90	12.5	35	8	6.2	3	7.1	● 198978
8	1.25	90	12.5	35	8	6.2	3	6.9	● 198979
10	1.25	100	14	39	10	8	3	8.9	● 198980
10	1.5	100	14	39	10	8	3	8.6	● 198981
Ø d ₁ MJ	P mm	l ₁ mm	l ₂ mm		d ₂ mm	a mm			ID
3	0.5	56	12		3.5	2.7	3	2.55	● 199006
4	0.7	63	14		4.5	3.4	3	3.4	● 199007
5	0.8	70	15		6	4.9	3	4.3	● 199008
6	1	80	20		6	4.9	3	5.1	● 199009
8	1	90	25		8	6.2	3	7.1	● 199010
8	1.25	90	25		8	6.2	3	6.9	● 199011
10	1.25	100	30		10	8	3	8.9	● 199012
10	1.5	100	30		10	8	3	8.6	● 199013

≤ MJ5x0.8 = **4H6H**



aero

SA320-4



15 16 52 64

SA350-3



15 16 52 64

TL351VS-3



41 42

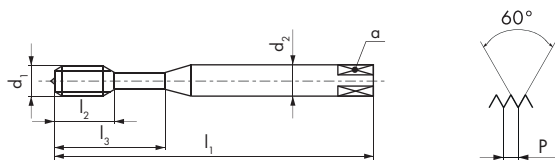

SA320-4

SA350-3

TL351VS-3



NEW

NEW

NEW



$\emptyset d_1$ MJ	P mm	l_1 mm	l_2 mm	l_3 mm	d_2 mm	a mm		
3	0.5	56	12		3.5	2.7	3	2.55
4	0.7	63	14		4.5	3.4	3	3.4
5	0.8	70	15		6	4.9	3	4.3
6	1	80	15	23	6	4.9	3	5.1
8	1	90	18	29	8	6.2	3	7.1
8	1.25	90	18	29	8	6.2	3	6.9
10	1.25	100	20	33	10	8	3	8.9
10	1.5	100	20	33	10	8	3	8.6

ID	ID	ID
● 198990	● 198998	● 198982
● 198991	● 198999	● 198983
● 198992	● 199000	● 198984
● 198993	● 199001	● 198985
● 198994	● 199002	● 198986
● 198995	● 199003	● 198987
● 198996	● 199004	● 198988
● 198997	● 199005	● 198989

≤MJ5x0.8 = **4H6H**



PM

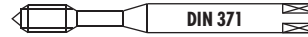

DIN 371



DIN 371

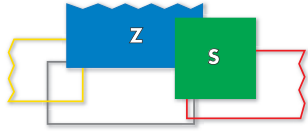

S320VS-4



13 15 16 22
23 24 52

S370VX-3



15 22 23 24
51 52 61

aero

SA390-3



16 53

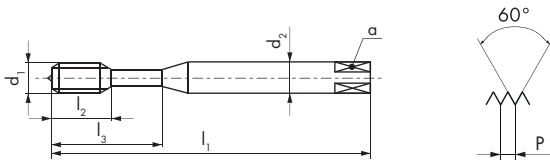

S320VS-4

S370VX-3

SA390-3



NEW

NEW

NEW





≤ 2.5 x D

< 1.5 x D



< 1.5 x D



Ø" d ₁ UNJC	P TPI	d ₁ mm	l ₁ mm	l ₂ mm	l ₃ mm	d ₂ mm	a mm		
6	32	3.5	56	13	20	4	3	3	2.8
8	32	4.16	63	14	21	4.5	3.4	3	3.45
10	24	4.82	70	15	25	6	4.9	3	3.9
1/4	20	6.35	80	17	30	7	5.5	3	5.2



ID

- 199014
- 199015
- 199016
- 199017

Ø" d ₁ UNJC	P TPI	d ₁ mm	l ₁ mm	l ₂ mm	l ₃ mm	d ₂ h ₆ mm	a mm		
6	32	3.5	56	6.5	20	4 (h9)	3	3	2.8
8	32	4.16	63	7.5	21	4.5(h9)	3.4	3	3.45
10	24	4.82	70	9	25	6	4.9	3	3.9
1/4	20	6.35	80	11	30	6	4.9	3	5.2

ID

- 199018
- 199019
- 199020
- 199021

Ø" d ₁ UNJC	P TPI	d ₁ mm	l ₁ mm	l ₂ mm	d ₂ mm	a mm		
6	32	3.5	56	13	4	3	3	2.8
8	32	4.16	63	14	4.5	3.4	3	3.45
10	24	4.82	70	15	6	4.9	3	3.9
1/4	20	6.35	80	20	7	5.5	3	5.2

ID

- 199034
- 199035
- 199036
- 199037



aero

SA320-4



15 16 52 64

SA350-3



15 16 52 64

TL351VS-3



41 42

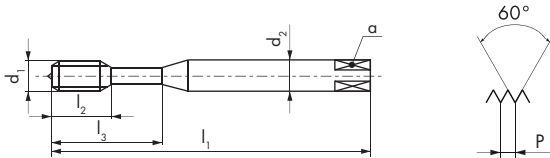

SA320-4

SA350-3

TL351VS-3



NEW

NEW

NEW



< 1.5 x D

< 2 x D



< 2 x D



4 x P



2.5 x P



2.5 x P



3B



3B



3B

Ø" d ₁ UNJC	P TPI	d ₁ mm	l ₁ mm	l ₂ mm	l ₃ mm	d ₂ mm	a mm		
6	32	3.5	56	13		4	3	3	2.8
8	32	4.16	63	14		4.5	3.4	3	3.45
10	24	4.82	70	15		6	4.9	3	3.9
1/4	20	6.35	80	15	23	7	5.5	3	5.2

ID	ID	ID
● 199026	● 199030	● 199022
● 199027	● 199031	● 199023
● 199028	● 199032	● 199024
● 199029	● 199033	● 199025



PM

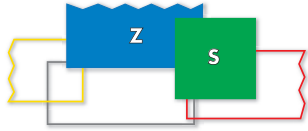
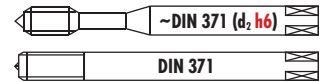
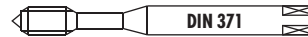

S320VS-4

S370VX-3

aero

SA390-3

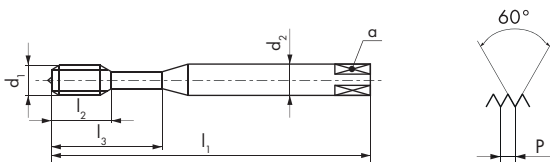

Ø" d ₁ UNJF	P TPI	d ₁ mm	l ₁ mm	l ₂ mm	l ₃ mm	d ₂ mm	a mm		
10	32	4.82	70	15	25	6	4.9	3	4.1
1/4	28	6.35	80	17	30	7	5.5	3	5.55
5/16	24	7.93	90	20	35	8	6.2	3	7
3/8	24	9.52	100	22	39	10	8	3	8.6

Ø" d ₁ UNJF	P TPI	d ₁ mm	l ₁ mm	l ₂ mm	l ₃ mm	d ₂ h ₆ mm	a mm		
10	32	4.82	70	9	25	6	4.9	3	4.1
1/4	28	6.35	80	11	30	6	4.9	3	5.55
5/16	24	7.93	90	12.5	35	8	6.2	3	7
3/8	24	9.52	100	14	39	10	8	3	8.6

Ø" d ₁ UNJF	P TPI	d ₁ mm	l ₁ mm	l ₂ mm	d ₂ mm	a mm		
10	32	4.82	70	15	6	4.9	3	4.1
1/4	28	6.35	80	20	7	5.5	3	5.55
5/16	24	7.93	90	25	8	6.2	3	7
3/8	24	9.52	100	30	10	8	3	8.6

S320VS-4	S370VX-3	SA390-3
NEW	NEW	NEW
3B	3B	3B
ID	ID	ID
<ul style="list-style-type: none"> 199038 199039 199040 199041 	<ul style="list-style-type: none"> 197707 197708 197709 197710 	<ul style="list-style-type: none"> 199049 199050 199051 199052



PM

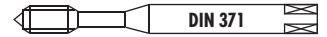

aero

SA320-4



15 16 52 64

SA350-3



15 16 52 64

TL351VS-3



VS

41 42

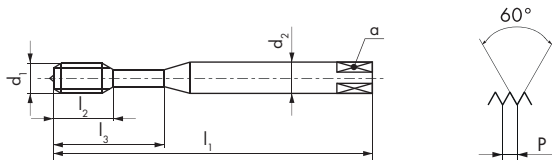

SA320-4

SA350-3

TL351VS-3



NEW



NEW



NEW



< 1.5 x D



< 2 x D



4 x P



2.5 x P



2.5 x P

3B

3B

3B

\emptyset " d ₁ UNJF	P TPI	d ₁ mm	l ₁ mm	l ₂ mm	l ₃ mm	d ₂ mm	a mm		
10	32	4.82	70	15		6	4.9	3	4.1
1/4	28	6.35	80	15	23	7	5.5	3	5.55
5/16	24	7.93	90	18	29	8	6.2	3	7
3/8	24	9.52	100	20	33	10	8	3	8.6

ID

ID

ID

● 174976	● 188175	● 199042
● 175993	● 199046	● 199043
● 175995	● 199047	● 199044
● 175997	● 199048	● 199045

ANDERE GEWINDELÖSUNGEN – OTHER THREADING SOLUTIONS



ISO 3161 ohne Radius

Wird die Gewindeskennzeichnung "J" in Klammer dargestellt (bsp. UN(J) für UN-Gewinde), werden die Gewindeschneidwerkzeuge ohne Radius im Aussendurchmesser hergestellt. Sie sind jedoch für UNJ, UNJC, UNJF-Gewinde nach ISO 3161 einsetzbar, wenn ein Radius im Gewindegrund nicht unbedingt erforderlich ist.

DC SWISS bietet ein breites Standardprogramm zur Herstellung von M, UNC(J), UNF(J) und EG-Gewinden in der respektiven 4H, 3B oder 6Hmod Toleranz an (ISO 5855 / ISO 3161 / ISO DIN 8140).

ISO 3161 without radius

Thread indications labeled with a "J" in brackets (for example UN(J) for UN threads) mean that the threading tools will be without radius on the outside diameter. These cutting tools are suitable for UNJ, UNJC, UNJF threads as per ISO 3161, when a radius on the thread bottom is not specifically required.

DC SWISS offers a wide range of standard tools for M, UNC(J), UNF(J) and EG threads in the requested 4H, 3B or 6Hmod tolerances (ISO 5855 / ISO 3161 / ISO DIN 8140).



**IN UNSEREM
KATALOG TC**

**IN OUR
CATALOGUE TC**



**IN UNSEREM
KATALOG TM**

**IN OUR
CATALOGUE TM**

**UND AUF UNSERER WEBSITE — AND ON OUR WEBSITE
DCSWISS.COM**

**FINDEN SIE WEITERE GEWINDEWERKZEUGE FÜR DIE LUFTFAHRT SOWIE ZUSÄTZLICHE TECH-
NISCHE INFORMATIONEN.**



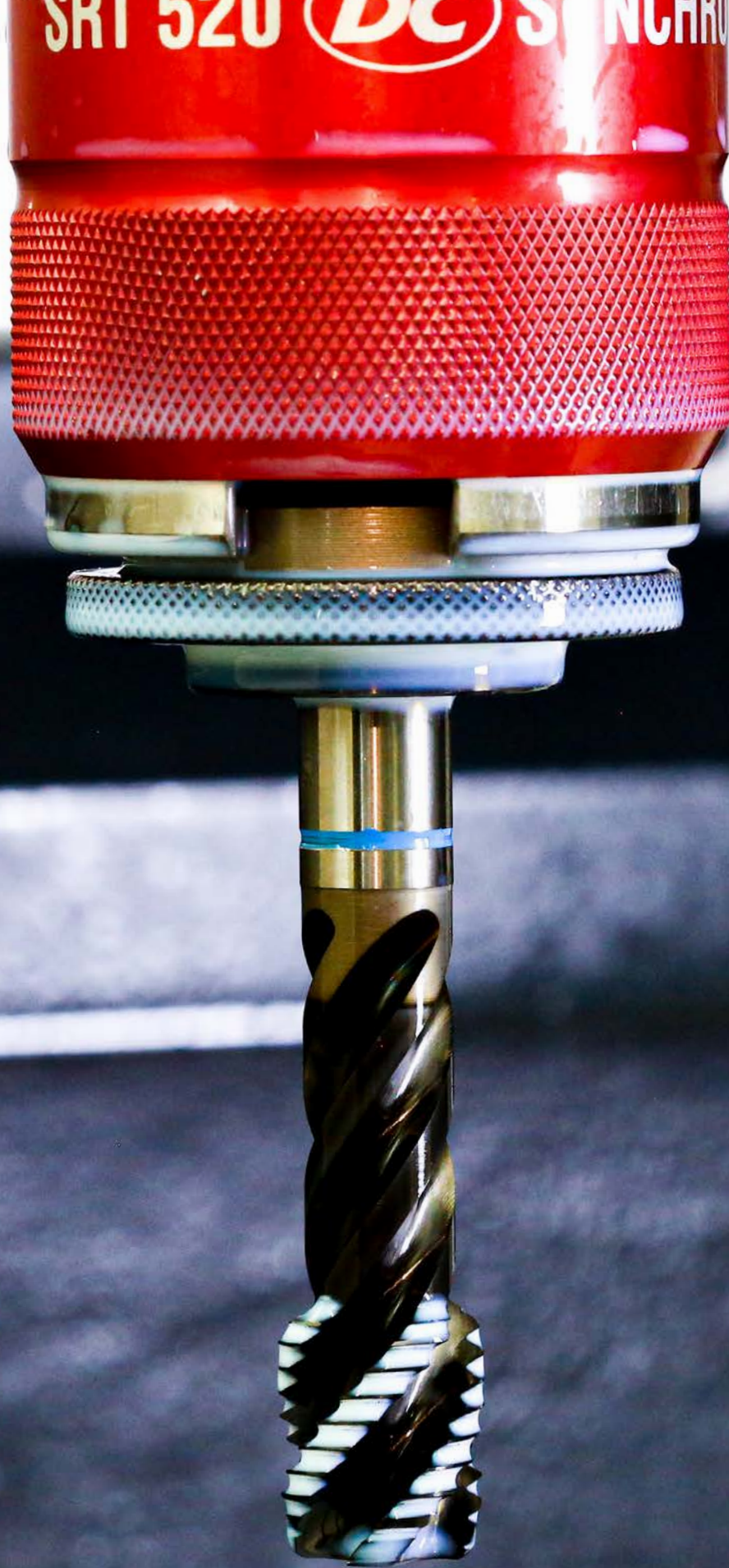





**YOU WILL FIND MORE THREADING TOOLS RELATED TO AERONAUTICS AND ADDITIONAL
TECHNICAL INFORMATION.**

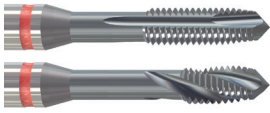

**KLASSISCHES UND
SYNCHRON-GEWINDESCHNEIDEN**

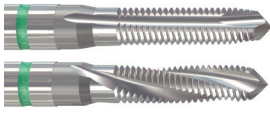
CLASSIC THREAD CUTTING AND RIGID TAPPING

DC-SCHNEIDENGEOMETRIEN — DC CUTTING GEOMETRIES

N		<p>Für normale Werkstoffe (Automatenstahl; Baustahl; Einsatzstahl; Kohlenstoffstahl; Stahl legiert < 850 N/mm²; rost- freier Stahl, geschwefelt; Kugel- graphitguss; Temperguss; Messing langspanend; Al legiert, Si < 10 %)</p>	<p>For normal materials (free-cutting steels; structural, cementation steels; carbon steels; alloy steels < 850 N/mm²; free machining stainless steels; spheroidal graphite + malleable cast iron; long chip brass; Al alloyed Si < 10 %)</p>
W		<p>Für weiche Werkstoffe (Aluminium unlegiert; niedrig legiertes Aluminium; Thermoplaste)</p>	<p>For soft materials (aluminium unalloyed; low-alloyed aluminium; thermoplastics)</p>
Z		<p>Für zähe Werkstoffe (rost- und säurebeständige Werkstoffe - austenitisch; ferritisch, martensitisch < 850 N/mm²; Reintitan; Nickellegierung 1 < 850 N/mm²; Reinkupfer)</p>	<p>For tough materials (rust and acid resistant mate- rials - austenitic stainless steels; ferritic and martensitic < 850 N/mm²; pure titanium; nickel alloys 1 < 850 N/mm²; pure copper)</p>
H		<p>Für hochfeste Werkstoffe > 850 - < 1'400 N/mm² ((legierte Stähle, Vergü- tungsstähle - hochfester Stahl); Messing, Bronze, Rotguss (kurzspanend); Messing bleifrei; Duroplaste; glasfaserverstärkte Kunststoffe)</p>	<p>For high tensile materials > 850 - < 1'400 N/mm² ((alloyed steels, tempered steels - high tensile alloy steels); short chip brass + phos- phor bronze + gun metal; lead- free brass; duroplastics; glass fibre reinforced plastics)</p>
S		<p>Für sonderlegierte Werkstoffe > 850 - < 1'150 N/mm² (Stahl legiert / vergütet; ferritisch, martensitische Stähle; Nickellegierung 2)</p>	<p>For special alloyed materials > 850 - < 1'150 N/mm² (alloy steels hardened / tempered; ferritic, martensitic steels; nickel alloys 2)</p>
SA AERO SA.20 / SA.50		<p>Für sonderlegierte Werkstoffe > 850 - < 1'150 N/mm² (Nickellegierung 2; Messing bleifrei)</p>	<p>For special alloyed materials > 850 - < 1'150 N/mm² (nickel alloys 2; lead-free brass)</p>
SA AERO SA.90		<p>Für sonderlegierte Werkstoffe > 1'150 - < 1'600 N/mm² (Nickellegierung 3)</p>	<p>For special alloyed materials > 1'150 - < 1'600 N/mm² (nickel alloys 3)</p>
TL		<p>Für Titanlegierungen</p>	<p>For titanium alloys</p>
QTAP NEW		<p>Der DC-ALLROUNDER (für den universellen Einsatz in verschiedenen Werkstoffen bis zu 1'150 N/mm², für den Einsatz im Längenausgleichsfutter und das Synchron-Gewindeschneiden)</p>	<p>The DC ALLROUNDER (for universal use in different materials up to 1'150 N/mm², for use in tapping chucks with axial compensation and for synchronous tapping)</p>

ANWENDUNGSTABELLE — APPLICATION CHART

Gewindeschneiden Thread cutting

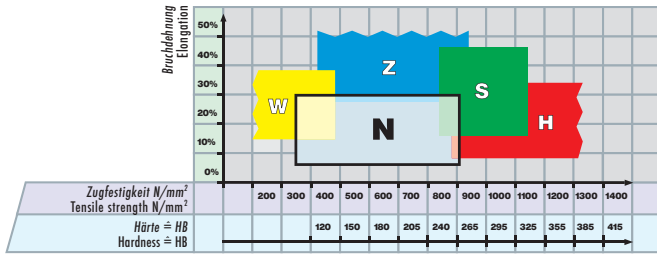

Gewindeschneiden Thread cutting

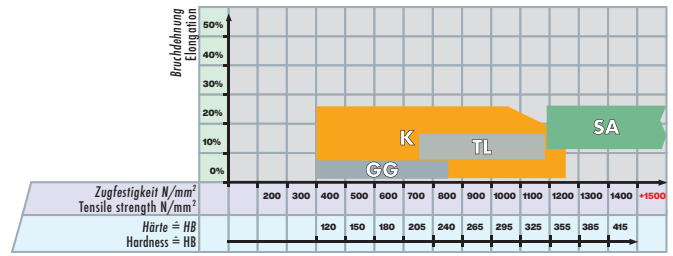

Gewindeschneiden klassisch und synchron Thread cutting classic and rigid

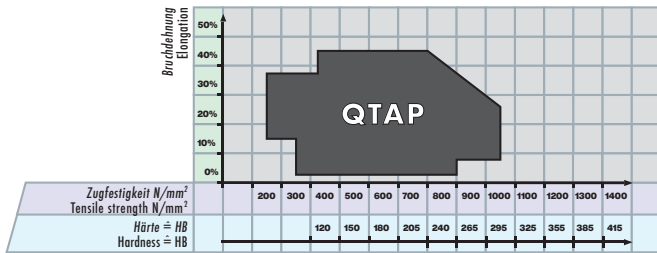

Synchron-Gewindeschneiden Rigid Tapping

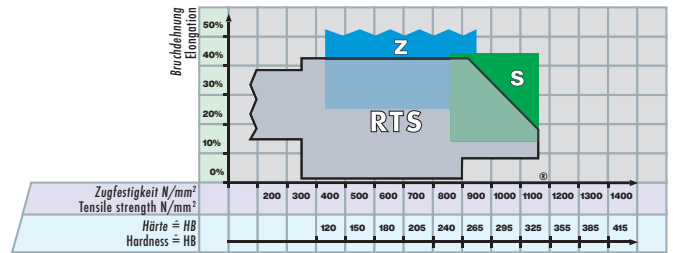

DC -Anwendungsgruppen

DC Material classification

Werkstoff-Gruppen Material groups	Werkstoffbezeichnung	Material designation	Härte Hardness (HB)	Festigkeit Tensile strength Rm (N/mm ²)	Dehnung Elongation A (%)
10 Stahl Steels	11 Automatenstahl	Free-cutting steels	< 200	< 700	< 10
	12 Baustahl, Einsatzstahl	Structural, cementation steels	< 200	< 700	< 30
	13 Kohlenstoffstahl	Carbon steels	< 300	< 1000	< 20
	14 Stahl legiert < 850 N/mm ²	Alloy steels < 850 N/mm ²	< 250	< 850	< 30
	15 Stahl legiert / vergütet > 850 - < 1150 N/mm ²	Alloy steels hard. / temp. > 850 - < 1150 N/mm ²	> 250	> 850	< 30
	16 Hochfester Stahl ≤ 44 HRC	High tensile alloy steels ≤ 44 HRC	> 250	> 850	< 12
	17 Stahl vergütet > 44 - ≤ 54 HRC	Alloy steels tempered > 44 - ≤ 54 HRC	> 410	> 1400	< 2
	18 Stahl gehärtet > 54 - ≤ 63 HRC	Alloy steels hardened > 54 - ≤ 63 HRC	> 560	> 1980	< 2
20 Rostfreier Stahl Stainless steels	21 Rostfreier Stahl, geschwefelt	Free machining stainless steels	< 250	< 850	< 25
	22 Austenitisch	Austenitic stainless steels	< 250	< 850	> 20
	23 Ferritisch, martensitisch < 850 N/mm ²	Ferritic and martensitic < 850 N/mm ²	< 250	< 850	> 20
	24 Ferritisch, martensitisch > 850 - < 1150 N/mm ²	Ferritic and martensitic > 850 - < 1150 N/mm ²	> 250	> 850	> 15
30 Guss Cast iron	31 Grauguss	Cast iron	< 250	< 850	< 10
	32 Kugelgraphitguss, Temporguss	Spheroidal graphite + malleable cast iron	< 250	< 850	> 10
40 Titan Titanium	41 Reintitan	Pure titanium	< 250	< 850	> 20
	42 Titanlegierung	Titanium alloys	> 250	> 850	< 20
50 Nickel Nickel	51 Nickellegierung 1 ≤ 850 N/mm ²	Nickel alloys 1 ≤ 850 N/mm ²	< 250	< 850	> 25
	52 Nickellegierung 2 > 850 - ≤ 1150 N/mm ²	Nickel alloys 2 > 850 - ≤ 1150 N/mm ²	> 250	> 850	< 25
	53 Nickellegierung 3 > 1150 - ≤ 1600 N/mm ²	Nickel alloys 3 > 1150 - ≤ 1600 N/mm ²	> 340	> 1150	< 20
60 Kupfer Copper	61 Reinkupfer (Elektrolytkupfer)	Pure copper (electrolytic copper)	< 120	< 400	> 12
	62 Messing, Bronze, Rotguss (kurzspanend)	Short chip brass, phosphor bronze, gun metal	< 200	< 700	< 12
	63 Messing (langspanend)	Long chip brass	< 200	< 700	> 12
	64 Messing bleifrei	Lead free brass	< 220	< 700	> 15
70 Aluminium Magnesium Aluminium Magnesium	71 Al unlegiert	Al unalloyed	< 100	< 350	> 15
	72 Al legiert Si < 1.5 %	Al alloyed Si < 1.5 %	< 150	< 500	> 15
	73 Al legiert Si > 1.5 % - < 10 %	Al alloyed Si > 1.5 % - < 10 %	< 120	< 400	< 15
	74 Al legiert Si > 10 %, Mg-Legierungen	Al alloyed Si > 10 %, Mg-alloys	< 120	< 400	< 10
80 Kunststoff Plastic compounds	81 Thermoplaste	Thermoplastics	-	-	-
	82 Duroplaste	Duroplastics	-	-	-
	83 Faserverstärkte Kunststoffe	Glass fibre reinforced plastics	-	-	-
90 Edelmetalle Precious metals	91 Gelbgold	Yellow gold	-	-	-
	92 Rotgold	Red gold	-	-	-
	93 Weissgold	White gold	-	-	-
	94 Silber	Silver	-	-	-

		N		W		Z		H		S		SA			TL		QTAP				
		Normale Werkstoffe Normal materials		Weiche Werkstoffe Soft materials		Zähe Werkstoffe Tough materials		Hochfeste Werkstoffe High tensile materials		Sonderleg. Werkstoffe Special alloys		Sonderlegierte Werkstoffe Special alloys			Titanlegierungen Titanium alloys		Allrounder Allrounder				
		N.20	N.60	W.20DL	W.60DL	Z.20VS	Z.70VS	H.20TC	H.50TC	S.20VS	S.60VS	SA.20	SA.50	SA.90	TL.20VS	TL.51VS	Q.20VS	Q.60VS			
11																					11
12																					12
13																					13
14																					14
15																					15
16																					16
17																					17
18																					18
21																					21
22																					22
23																					23
24																					24
31																					31
32																					32
41																					41
42																					42
51																					51
52																					52
53																					53
61																					61
62																					62
63																					63
64																					64
71																					71
72																					72
73																					73
74																					74
81																					81
82																					82
83																					83
91																					91
92																					92
93																					93
94																					94

A Optimal mit Luft
Optimal with air

A Geeignet mit Luft
Suitable with air

Bedingt geeignet
Limited

Bei den oben aufgeführten Daten handelt es sich um Richtwerte.
The indicated values are a guideline.



GEWINDEWIRBELN
THREAD WHIRLING

SPEZIFIZIERUNGEN — SPECIFICATIONS

Gewindewirbler **GW SERIES 1000** — Thread whirl cutter **GW SERIES 1000**



- Universell einsetzbar
- Hohe Prozesssicherheit
- Für kleinste Durchmesser geeignet
- Mehr Raum für die Spanevakuierung
- Für Gewindetiefen bis $2.5 \times D_1$

-
- Universal application
 - High process security
 - Suitable for the smallest dimensions
 - More space for chip evacuation
 - For threading depths up to $2.5 \times D_1$

Gewindewirbler **GW SERIES 2000** — Thread whirl cutter **GW SERIES 2000**



- Vorschubgeschwindigkeit multipliziert mit der Anzahl der Zähne
- Weniger Verschleiss, verbesserte Standzeit
- Variable Anzahl Zähne, je nach Abmessung
- Für Gewindetiefen bis $2.5 \times D_1$

-
- Feed rate multiplied by number of teeth
 - Less wear, longer tool life
 - The number of teeth varies, depending on the size
 - For threading depths up to $2.5 \times D_1$

Gewindewirbler **GW SERIES 3000** — Thread whirl cutter **GW SERIES 3000**



- Prozesssicherheit, weniger Radius-Werkzeugkorrekturen auf der CNC
- Für Gewindetiefen bis $4 \times D_1$

-
- Secure process, reduction in NC-corrections
 - For threading depths up to $4 \times D_1$

Gewindewirbler **GWi SERIES 3000** — Thread whirl cutter **GWi SERIES 3000**



- Dank optimaler, spezifischer Kühlmittelzufuhr:
 - verbesserte Spanabfuhr
 - doppelte Standzeit
- Für Gewindetiefen bis $4 \times D_1$

-
- Thanks to an optimal, specific coolant supply:
 - improved chip evacuation
 - twice the tool life
 - For threading depths up to $4 \times D_1$

SPEZIFIZIERUNGEN — SPECIFICATIONS

Gewindewirbler **GWi** SERIES 5000 — Thread whirl cutter **GWi** SERIES 5000

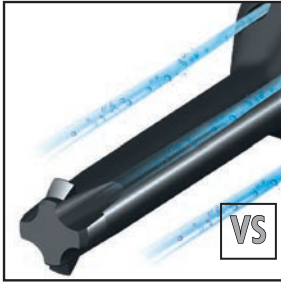

- Seine spezifische Geometrie erlaubt das Schlichten des Kerndurchmessers und auch das Entgraten des hergestellten Profils
- Geometrisch einwandfreies Gewinde dank spezieller Schnittaufteilung
- Für absolut gratfreie Gewinde, selbst in schwer zerspanbaren Werkstoffen, unter Einhaltung der Masshaltigkeit (Toleranz)
- Hohe Oberflächenqualität dank spezifischer Schneidkantenkonditionierung
- Sehr gute Spanevakuierung und hohe Standzeit dank optimaler Kühlmittelzufuhr
- Prozesssicherheit, weniger Radius-Werkzeugkorrekturen auf der CNC
- LH-Rotation - Gleichlaufräsen - linksschneidend für weniger Druck auf den Schneidkanten
- Für Gewindetiefen bis $3 \times D_1$

-
- Its specific geometry allows the final milling of the internal diameter and also the deburring of the realised profile
 - Geometrically perfect thread thanks to special cutting division
 - For absolutely burr-free threads, even in difficult-to-machine materials, while maintaining dimensional accuracy (tolerance)
 - High surface quality thanks to specific cutting edge conditioning
 - Improved chip evacuation and long tool life thanks to optimum coolant supply
 - Secure process, reduction in NC-corrections
 - LH-Rotation - climb milling - left-hand cutting for less pressure on the cutting edges
 - For threading depths up to $3 \times D_1$

Gewindewirbler **GWH** SERIES 3000 — Thread whirl cutter **GWH** SERIES 3000



- Speziell angepasste Schneidengeometrie für hohe Prozesssicherheit bei der Bearbeitung von hochfesten Werkstoffen bis 63 HRC
- Hohe Oberflächenqualität dank spezifischer Schneidkantenkonditionierung
- LH-Rotation - Gleichlaufräsen - linksschneidend für weniger Druck auf den Schneidkanten
- Für Gewindetiefen bis $3 \times D_1$

-
- Special cutting geometry for high process security when machining high-tensile materials up to 63 HRC
 - High surface quality thanks to specific cutting edge conditioning
 - LH-Rotation - climb milling - left-hand cutting for less pressure on the cutting edges
 - For threading depths up to $3 \times D_1$

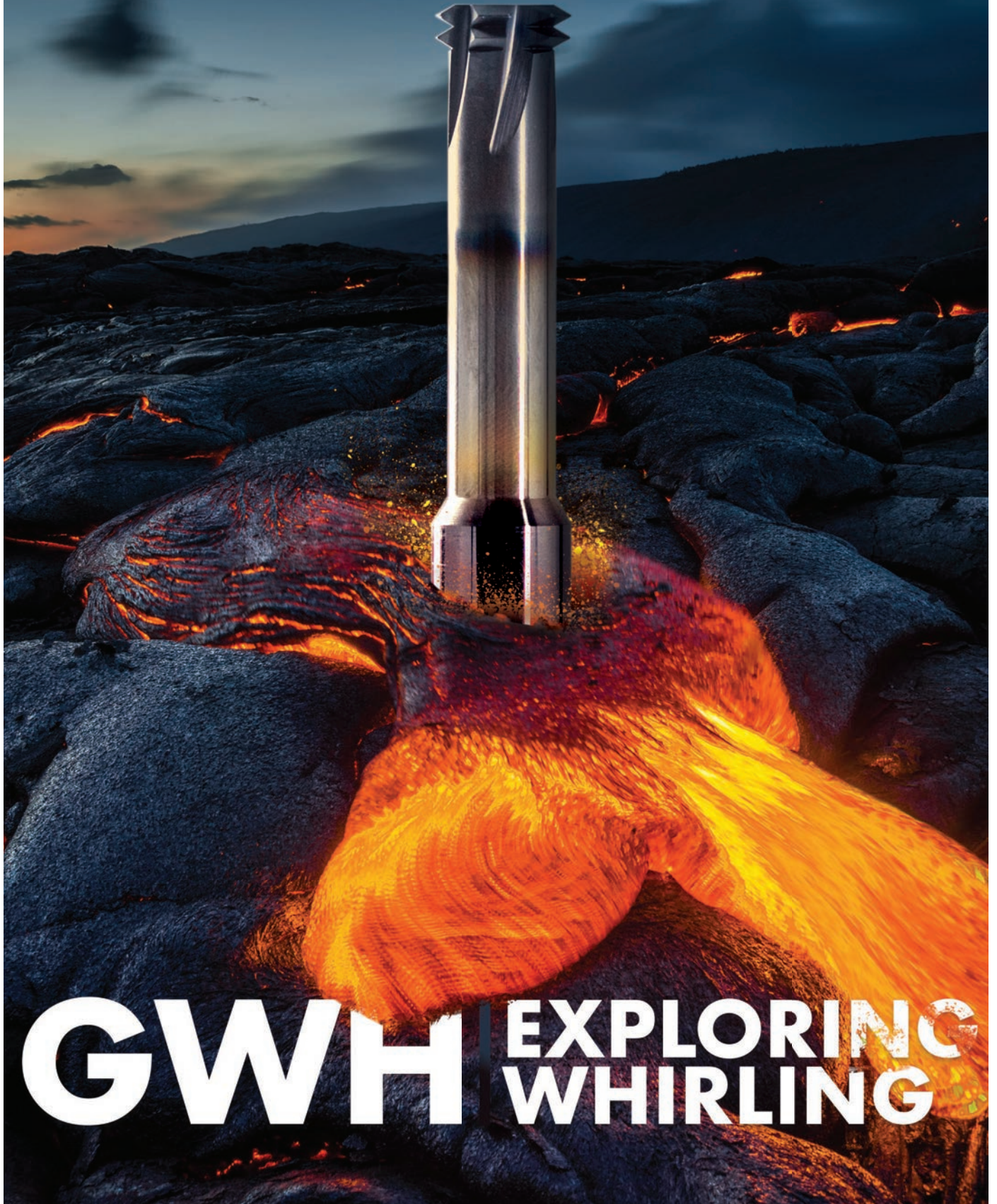

GWH | EXPLORING WHIRLING



ANWENDUNGSTABELLE GW — APPLICATION CHART GW

Programmierzklus für Gewindewirbler GW1000 und GW2000 Programming cycle for thread whirling GW1000 and GW2000

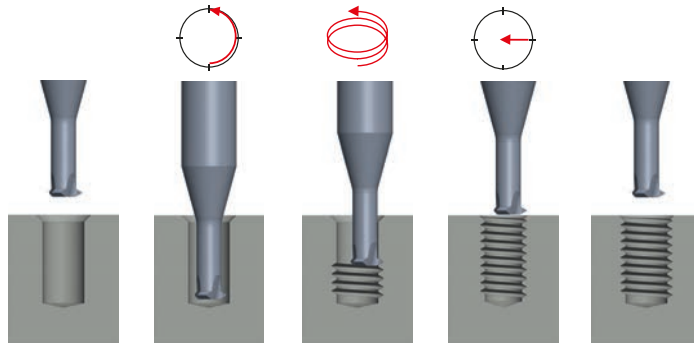

DC Anwendungstabelle für Gewindewirbler DC Application chart for thread whirling

Werkstoff-Gruppen Material groups	Werkstoffbezeichnung Material designation	Härte Hardness (HB)	Festigkeit Tensile strength Rm (N/mm ²)	Kühlung Lubricant		
				Standard Standard	Beschichtet Coated	
10 Stahl Steels	11 Automatenstahl	Free-cutting steels	< 200	< 700		OE
	12 Baustahl, Einsatzstahl	Structural, cementation steels	< 200	< 700		OE
	13 Kohlenstoffstahl	Carbon steels	< 300	< 1000		OE
	14 Stahl legiert < 850 N/mm ²	Alloy steels < 850 N/mm ²	< 250	< 850		OE
	15 Stahl legiert / vergütet > 850 - < 1150 N/mm ²	Alloy steels hard. / temp. > 850 - < 1150 N/mm ²	> 250	> 850		OE
	16 Hochfester Stahl ≤ 44 HRC	High tensile alloy steels ≤ 44 HRC	> 250	> 850		OE
	17 Stahl vergütet > 44 - ≤ 54 HRC	Alloy steels tempered > 44 - ≤ 54 HRC	> 410	> 1400		OE
	18 Stahl gehärtet > 54 - ≤ 63 HRC	Alloy steels hardened > 54 - ≤ 63 HRC	> 560	> 1980		
20 Rostfreier Stahl Stainless steels	21 Rostfreier Stahl, geschwefelt	Free machining stainless steels	< 250	< 850		OE
	22 Austenitisch	Austenitic stainless steels	< 250	< 850		OE
	23 Ferritisch, martensitisch < 850 N/mm ²	Ferritic and martensitic < 850 N/mm ²	< 250	< 850		OE
	24 Ferritisch, martensitisch > 850 - < 1150 N/mm ²	Ferritic and martensitic > 850 - < 1150 N/mm ²	> 250	> 850		OE
30 Guss Cast iron	31 Grauguss	Cast iron	< 250	< 850		OE A
	32 Kugelgraphitguss, Temperguss	Spheroidal graphite + malleable cast iron	< 250	< 850		OE
40 Titan Titanium	41 Reintitan	Pure titanium	< 250	< 850	OE	OE
	42 Titanlegierung	Titanium alloys	> 250	> 850	OE	OE
50 Nickel Nickel	51 Nickellegierung 1 ≤ 850 N/mm ²	Nickel alloys 1 ≤ 850 N/mm ²	< 250	< 850		OE
	52 Nickellegierung 2 > 850 - ≤ 1150 N/mm ²	Nickel alloys 2 > 850 - ≤ 1150 N/mm ²	> 250	> 850		OE
	53 Nickellegierung 3 > 1150 - ≤ 1600 N/mm ²	Nickel alloys 3 > 1150 - ≤ 1600 N/mm ²	> 340	> 1150		OE
60 Kupfer Copper	61 Reinkupfer (Elektrolytkupfer)	Pure copper (electrolytic copper)	< 120	< 400	OE	OE
	62 Messing, Bronze, Rotguss (kurzspanend)	Short chip brass, phosphor bronze, gun metal	< 200	< 700	OE A	OE A
	63 Messing (langspanend)	Long chip brass	< 200	< 700	OE	OE
	64 Messing bleifrei	Lead free brass	< 220	< 700	OE	OE
70 Aluminium Magnesium Aluminium Magnesium	71 Al unlegiert	Al unalloyed	< 100	< 350	OE	OE
	72 Al legiert Si < 1.5 %	Al alloyed Si < 1.5 %	< 150	< 500	OE	OE
	73 Al legiert Si > 1.5 % - < 10 %	Al alloyed Si > 1.5 % - < 10 %	< 120	< 400		OE
	74 Al legiert Si > 10 %, Mg-Legierungen	Al alloyed Si > 10 %, Mg-alloys	< 120	< 400		OE
80 Kunststoff Plastic compounds	81 Thermoplaste	Thermoplastics	-	-	E	E
	82 Duroplaste	Duroplastics	-	-	E	E
	83 Faserverstärkte Kunststoffe	Glass fibre reinforced plastics	-	-		E A
90 Edelmetalle Precious metals	91 Gelbgold	Yellow gold	-	-	OE	OE
	92 Rotgold	Red gold	-	-	OE	OE
	93 Weissgold	White gold	-	-		OE
	94 Silber	Silver	-	-		OE

Optimal mit Schneidöl
Optimal with cutting oil

Geeignet mit Schneidöl
Suitable with cutting oil

Optimal mit Emulsion
Optimal with emulsion

Geeignet mit Emulsion
Suitable with emulsion

ANWENDUNGSTABELLE GW - GWi — APPLICATION CHART GW - GWi

Programmierzklus für Gewindewirbler GW3000 - GWi3000

Programming cycle for thread whirling GW3000 - GWi3000

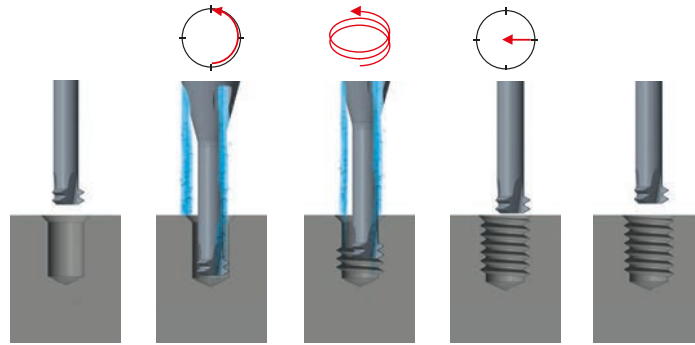

DC Anwendungstabelle für Gewindewirbler DC Application chart for thread whirling

Werkstoff-Gruppen Material groups	Werkstoffbezeichnung Material designation	Härte Hardness (HB)	Festigkeit Tensile strength Rm (N/mm ²)	Kühlung Lubricant		
				Standard Standard	Beschichtet Coated	
10 Stahl Steels	11 Automatenstahl	Free-cutting steels	< 200	< 700		OE
	12 Baustahl, Einsatzstahl	Structural, cementation steels	< 200	< 700		OE
	13 Kohlenstoffstahl	Carbon steels	< 300	< 1000		OE
	14 Stahl legiert < 850 N/mm ²	Alloy steels < 850 N/mm ²	< 250	< 850		OE
	15 Stahl legiert / vergütet > 850 - < 1150 N/mm ²	Alloy steels hard. / temp. > 850 - < 1150 N/mm ²	> 250	> 850		OE
	16 Hochfester Stahl ≤ 44 HRC	High tensile alloy steels ≤ 44 HRC	> 250	> 850		OE
	17 Stahl vergütet > 44 - ≤ 54 HRC	Alloy steels tempered > 44 - ≤ 54 HRC	> 410	> 1400		OE
	18 Stahl gehärtet > 54 - ≤ 63 HRC	Alloy steels hardened > 54 - ≤ 63 HRC	> 560	> 1980		
20 Rostfreier Stahl Stainless steels	21 Rostfreier Stahl, geschwefelt	Free machining stainless steels	< 250	< 850		OE
	22 Austenitisch	Austenitic stainless steels	< 250	< 850		OE
	23 Ferritisch, martensitisch < 850 N/mm ²	Ferritic and martensitic < 850 N/mm ²	< 250	< 850		OE
	24 Ferritisch, martensitisch > 850 - < 1150 N/mm ²	Ferritic and martensitic > 850 - < 1150 N/mm ²	> 250	> 850		OE
30 Guss Cast iron	31 Grauguss	Cast iron	< 250	< 850		OE A
	32 Kugelgraphitguss, Temperguss	Spheroidal graphite + malleable cast iron	< 250	< 850		OE
40 Titan Titanium	41 Reintitan	Pure titanium	< 250	< 850	OE	OE
	42 Titanlegierung	Titanium alloys	> 250	> 850	OE	OE
50 Nickel Nickel	51 Nickellegierung 1 ≤ 850 N/mm ²	Nickel alloys 1 ≤ 850 N/mm ²	< 250	< 850		OE
	52 Nickellegierung 2 > 850 - ≤ 1150 N/mm ²	Nickel alloys 2 > 850 - ≤ 1150 N/mm ²	> 250	> 850		OE
	53 Nickellegierung 3 > 1150 - ≤ 1600 N/mm ²	Nickel alloys 3 > 1150 - ≤ 1600 N/mm ²	> 340	> 1150		OE
60 Kupfer Copper	61 Reinkupfer (Elektrolytkupfer)	Pure copper (electrolytic copper)	< 120	< 400	OE	OE
	62 Messing, Bronze, Rotguss (kurzspanend)	Short chip brass, phosphor bronze, gun metal	< 200	< 700	OE A	OE A
	63 Messing (langspanend)	Long chip brass	< 200	< 700	OE	OE
	64 Messing bleifrei	Lead free brass	< 220	< 700	OE	OE
70 Aluminium Magnesium Aluminium Magnesium	71 Al unlegiert	Al unalloyed	< 100	< 350	OE	OE
	72 Al legiert Si < 1.5 %	Al alloyed Si < 1.5 %	< 150	< 500	OE	OE
	73 Al legiert Si > 1.5 % - < 10 %	Al alloyed Si > 1.5 % - < 10 %	< 120	< 400		OE
	74 Al legiert Si > 10 %, Mg-Legierungen	Al alloyed Si > 10 %, Mg-alloys	< 120	< 400		OE
80 Kunststoff Plastic compounds	81 Thermoplaste	Thermoplastics	-	-	E	E
	82 Duroplaste	Duroplastics	-	-	E	E
	83 Faserverstärkte Kunststoffe	Glass fibre reinforced plastics	-	-		E A
90 Edelmetalle Precious metals	91 Gelbgold	Yellow gold	-	-	OE	OE
	92 Rotgold	Red gold	-	-	OE	OE
	93 Weissgold	White gold	-	-		OE
	94 Silber	Silver	-	-		OE

A Optimal mit Luft
Optimal with air

A Geeignet mit Luft
Suitable with air

Bei den oben aufgeführten Daten handelt es sich um Richtwerte.
The indicated values are a guideline.

ANWENDUNGSTABELLE GWi - GWH – APPLICATION CHART GWi - GWH

Programmierzklus für Gewindewirbler GWi5000 - GWH3000

Programming cycle for thread whirling GWi5000 - GWH3000

GWi5000

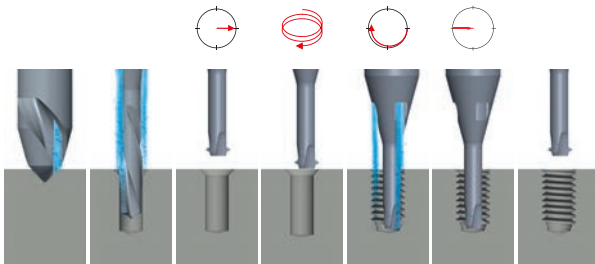

GWH3000

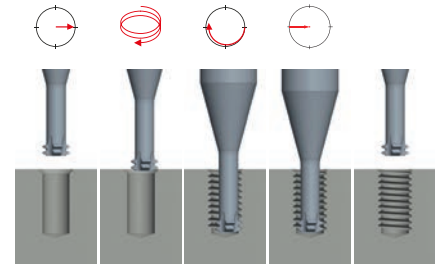

DC Anwendungstabelle für Gewindewirbler DC Application chart for thread whirling

Werkstoff-Gruppen Material groups	Werkstoffbezeichnung Material designation	Härte Hardness (HB)	Festigkeit Tensile strength Rm (N/mm ²)
10 Stahl Steels	11 Automatenstahl Free-cutting steels	< 200	< 700
	12 Baustahl, Einsatzstahl Structural, cementation steels	< 200	< 700
	13 Kohlenstoffstahl Carbon steels	< 300	< 1000
	14 Stahl legiert < 850 N/mm ² Alloy steels < 850 N/mm ²	< 250	< 850
	15 Stahl legiert / vergütet > 850 - < 1150 N/mm ² Alloy steels hard. / temp. > 850 - < 1150 N/mm ²	> 250	> 850
	16 Hochfester Stahl ≤ 44 HRC High tensile alloy steels ≤ 44 HRC	> 250	> 850
	17 Stahl vergütet > 44 - ≤ 54 HRC Alloy steels tempered > 44 - ≤ 54 HRC	> 410	> 1400
	18 Stahl gehärtet > 54 - ≤ 63 HRC Alloy steels hardened > 54 - ≤ 63 HRC	> 560	> 1980
20 Rostfreier Stahl Stainless steels	21 Rostfreier Stahl, geschwefelt Free machining stainless steels	< 250	< 850
	22 Austenitisch Austenitic stainless steels	< 250	< 850
	23 Ferritisch, martensitisch < 850 N/mm ² Ferritic and martensitic < 850 N/mm ²	< 250	< 850
	24 Ferritisch, martensitisch > 850 - < 1150 N/mm ² Ferritic and martensitic > 850 - < 1150 N/mm ²	> 250	> 850
30 Guss Cast iron	31 Grauguss Cast iron	< 250	< 850
	32 Kugelgraphitguss, Temperguss Spheroidal graphite + malleable cast iron	< 250	< 850
40 Titan Titanium	41 Reintitan Pure titanium	< 250	< 850
	42 Titanlegierung Titanium alloys	> 250	> 850
50 Nickel Nickel	51 Nickellegierung 1 ≤ 850 N/mm ² Nickel alloys 1 ≤ 850 N/mm ²	< 250	< 850
	52 Nickellegierung 2 > 850 - ≤ 1150 N/mm ² Nickel alloys 2 > 850 - ≤ 1150 N/mm ²	> 250	> 850
	53 Nickellegierung 3 > 1150 - ≤ 1600 N/mm ² Nickel alloys 3 > 1150 - ≤ 1600 N/mm ²	> 340	> 1150
60 Kupfer Copper	61 Reinkupfer (Elektrolytkupfer) Pure copper (electrolytic copper)	< 120	< 400
	62 Messing, Bronze, Rotguss (kurzspanend) Short chip brass, phosphor bronze, gun metal	< 200	< 700
	63 Messing (langspanend) Long chip brass	< 200	< 700
	64 Messing bleifrei Lead free brass	< 220	< 700
70 Aluminium Magnesium Aluminium Magnesium	71 Al unlegiert Al unalloyed	< 100	< 350
	72 Al legiert Si < 1.5 % Al alloyed Si < 1.5 %	< 150	< 500
	73 Al legiert Si > 1.5 % - < 10 % Al alloyed Si > 1.5 % - < 10 %	< 120	< 400
	74 Al legiert Si > 10 %, Mg-Legierungen Al alloyed Si > 10 %, Mg-alloys	< 120	< 400
80 Kunststoff Plastic compounds	81 Thermoplaste Thermoplastics	-	-
	82 Duroplaste Duroplastics	-	-
	83 Faserverstärkte Kunststoffe Glass fibre reinforced plastics	-	-
90 Edelmetalle Precious metals	91 Gelbgold Yellow gold	-	-
	92 Rotgold Red gold	-	-
	93 Weissgold White gold	-	-
	94 Silber Silver	-	-

Optimal mit Schneidöl
Optimal with cutting oil

Geeignet mit Schneidöl
Suitable with cutting oil

Optimal mit Emulsion
Optimal with emulsion

Geeignet mit Emulsion
Suitable with emulsion



GEWINDEFRÄSEN
THREAD MILLING

ANWENDUNGSTABELLE GF - GFH - GFS - GFM

APPLICATION CHART GF - GFH - GFS - GFM

Programmierzklus für Gewindefräser GF - GFH - GFS - GFM
 Programming cycle for thread milling cutters GF - GFH - GFS - GFM

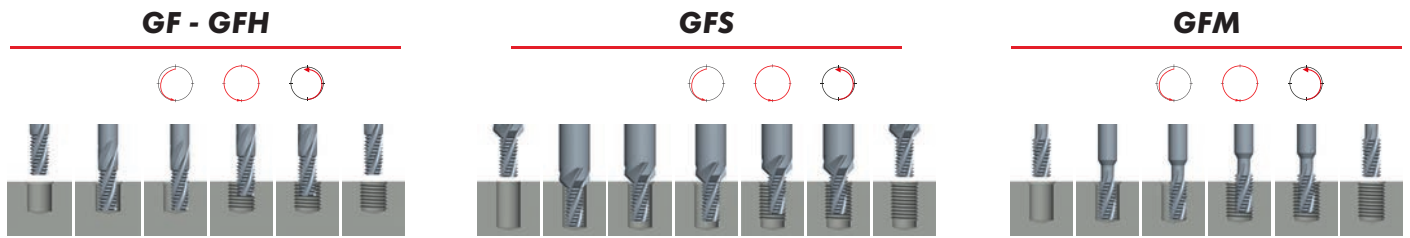

DC Anwendungstabelle für Gewindefräser **DC** Application chart for thread milling cutters

Werkstoff-Gruppen Material groups	Werkstoffbezeichnung Material designation	Härte Hardness (HB)	Festigkeit Tensile strength Rm (N/mm ²)	Kühlung Lubricant		
				Standard Standard	Beschichtet Coated	
10 Stahl Steels	11 Automatenstahl	Free-cutting steels	< 200	< 700		OE
	12 Baustahl, Einsatzstahl	Structural, cementation steels	< 200	< 700		OE
	13 Kohlenstoffstahl	Carbon steels	< 300	< 1000		OE
	14 Stahl legiert < 850 N/mm ²	Alloy steels < 850 N/mm ²	< 250	< 850		OE
	15 Stahl legiert / vergütet > 850 - < 1150 N/mm ²	Alloy steels hard. / temp. > 850 - < 1150 N/mm ²	> 250	> 850		OE
	16 Hochfester Stahl ≤ 44 HRC	High tensile alloy steels ≤ 44 HRC	> 250	> 850		OE
	17 Stahl vergütet > 44 - ≤ 54 HRC	Alloy steels tempered > 44 - ≤ 54 HRC	> 410	> 1400		OE
	18 Stahl gehärtet > 54 - ≤ 63 HRC	Alloy steels hardened > 54 - ≤ 63 HRC	> 560	> 1980		A
20 Rostfreier Stahl Stainless steels	21 Rostfreier Stahl, geschwefelt	Free machining stainless steels	< 250	< 850		OE
	22 Austenitisch	Austenitic stainless steels	< 250	< 850		OE
	23 Ferritisch, martensitisch < 850 N/mm ²	Ferritic and martensitic < 850 N/mm ²	< 250	< 850		OE
	24 Ferritisch, martensitisch > 850 - < 1150 N/mm ²	Ferritic and martensitic > 850 - < 1150 N/mm ²	> 250	> 850		OE
30 Guss Cast iron	31 Grauguss	Cast iron	< 250	< 850		OE A
	32 Kugelgraphitguss, Temperguss	Spheroidal graphite + malleable cast iron	< 250	< 850		OE
40 Titan Titanium	41 Reintitan	Pure titanium	< 250	< 850	OE	OE
	42 Titanlegierung	Titanium alloys	> 250	> 850	OE	OE
50 Nickel Nickel	51 Nickellegierung 1 ≤ 850 N/mm ²	Nickel alloys 1 ≤ 850 N/mm ²	< 250	< 850		OE
	52 Nickellegierung 2 > 850 - ≤ 1150 N/mm ²	Nickel alloys 2 > 850 - ≤ 1150 N/mm ²	> 250	> 850		OE
	53 Nickellegierung 3 > 1150 - ≤ 1600 N/mm ²	Nickel alloys 3 > 1150 - ≤ 1600 N/mm ²	> 340	> 1150		OE
60 Kupfer Copper	61 Reinkupfer (Elektrolytkupfer)	Pure copper (electrolytic copper)	< 120	< 400		OE
	62 Messing, Bronze, Rotguss (kurzspanend)	Short chip brass, phosphor bronze, gun metal	< 200	< 700	OE A	OE A
	63 Messing (langspanend)	Long chip brass	< 200	< 700	OE	OE
	64 Messing bleifrei	Lead free brass	< 220	< 700	OE	OE
70 Aluminium Magnesium Aluminium Magnesium	71 Al unlegiert	Al unalloyed	< 100	< 350	OE	OE
	72 Al legiert Si < 1.5 %	Al alloyed Si < 1.5 %	< 150	< 500	OE	OE
	73 Al legiert Si > 1.5 % - < 10 %	Al alloyed Si > 1.5 % - < 10 %	< 120	< 400		OE
	74 Al legiert Si > 10 %, Mg-Legierungen	Al alloyed Si > 10 %, Mg-alloys	< 120	< 400		OE
80 Kunststoff Plastic compounds	81 Thermoplaste	Thermoplastics	-	-	E	E
	82 Duroplaste	Duroplastics	-	-	E	E
	83 Faserverstärkte Kunststoffe	Glass fibre reinforced plastics	-	-		E A
90 Edelmetalle Precious metals	91 Gelbgold	Yellow gold	-	-	OE	OE
	92 Rotgold	Red gold	-	-	OE	OE
	93 Weissgold	White gold	-	-	OE	OE
	94 Silber	Silver	-	-		OE

O Optimal mit Schneidöl
Optimal with cutting oil

A Optimal mit Luft
Optimal with air

O Geeignet mit Schneidöl
Suitable with cutting oil

A Geeignet mit Luft
Suitable with air

E Optimal mit Emulsion
Optimal with emulsion

E Geeignet mit Emulsion
Suitable with emulsion

Bei den oben aufgeführten Daten handelt es sich um Richtwerte.
The indicated values are a guideline.

SPEZIFIZIERUNGEN — SPECIFICATIONS

GF



Standardausführung. Für das flexible Herstellen von Gewinden

- Für Gewinde bis fast auf den Grund der Vorbohrung
- Spiralnuten mit 27° Rechtsdrall (Typ GF62.. mit 15°)
- Mit Innenkühlung ab Durchmesser $d_1 = 4.50$ mm (UN $d_1 = 4.80$ mm)
- Standardausführung für den Durchmesserbereich von 2 bis 20 mm

Standard execution. For a flexible thread manufacturing

- For threads down to the bottom of the core hole
- With 27° right-hand spiral flutes (type GF62.. with 15°)
- With internal coolant from diameter $d_1 = 4.50$ mm (UN $d_1 = 4.80$ mm)
- Standard execution for the diameter range from 2 to 20 mm

GFH



Standardausführung. Für das flexible Herstellen von Gewinden

- Mit angepasster Schneidengeometrie für Stähle mit einer Härte von 55 bis 63 HRC
- Für Gewinde bis fast auf den Grund der Vorbohrung
- Spiralnuten mit 10° Rechtsdrall
- Standardausführung für den Durchmesserbereich von M3 bis M12

Standard execution. For a flexible thread manufacturing

- With adapted cutting angle to steels treated from 55 to 63 HRC
- For threads down to the bottom of the core hole
- With 10° right-hand spiral flutes
- Standard execution for threads from M3 to M12

GFS



Für das flexible Herstellen von Gewinden und das gleichzeitige Fräsen der Ansenkung

- Mit 45° Senkfase
- Spiralnuten mit 27° Rechtsdrall
- Mit Innenkühlung ab Durchmesser $d_1 = 4.50$ mm (UN $d_1 = 4.80$ mm)
- Standardausführung für den Durchmesserbereich von 2 bis 20 mm

For a flexible thread manufacturing with simultaneous countersinking

- With 45° chamfer for countersinking
- With 27° right-hand spiral flutes
- With internal coolant from diameter $d_1 = 4.50$ mm (UN $d_1 = 4.80$ mm)
- Standard execution for the diameter range from 2 to 20 mm

GFM



Für das vielseitige Herstellen von Gewinden, für verschiedene Durchmesser mit gleicher Steigung

- Für Gewinde bis fast auf den Grund der Vorbohrung. Auf Anfrage mit Stirnschneider und / oder Stirnsenker lieferbar
- Spiralnuten mit 15° Rechtsdrall
- Mit Innenkühlung
- Standardausführung für den Durchmesserbereich ab 10 mm

For a multiple thread manufacturing for a wide range of diameters with the same pitch

- For threads down to the bottom of the core hole or with spot facing cutter and countersinking (on request)
- With 15° right-hand spiral flutes
- With internal coolant
- Standard execution available from diameter 10 mm

SPEZIALAUSFÜHRUNGEN

Wir bieten Ihnen ein breites Standardprogramm an, basierend auf den heutigen technischen Standards und den allgemeinen Bedürfnissen unserer Kunden. Sollten Sie in unserem Standardprogramm nicht das für das von Ihnen zu bearbeitende Werkstück geeignete Gewindewerkzeug finden, unterbreiten wir Ihnen gerne ein Angebot für das für Ihren Anwendungsfall passende Werkzeug.

SPECIAL EXECUTIONS

We offer you a wide range of standard products, based on today's technical standards and the general needs of our customers. If you should not find in our standard programme the right tool for your workpiece to be machined, we will gladly make you an offer for the custom-made threading tool in special execution, adapted to your application.

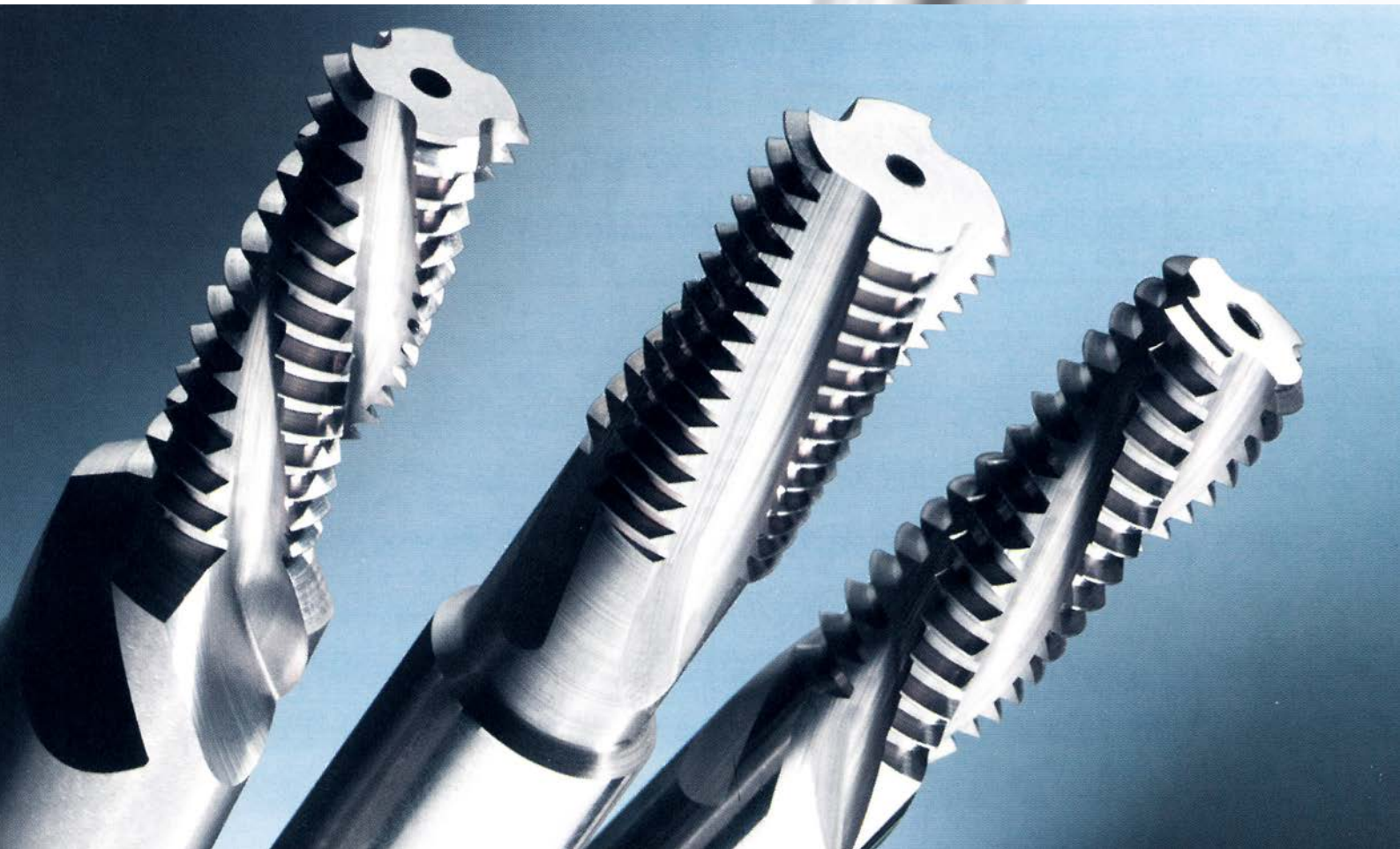
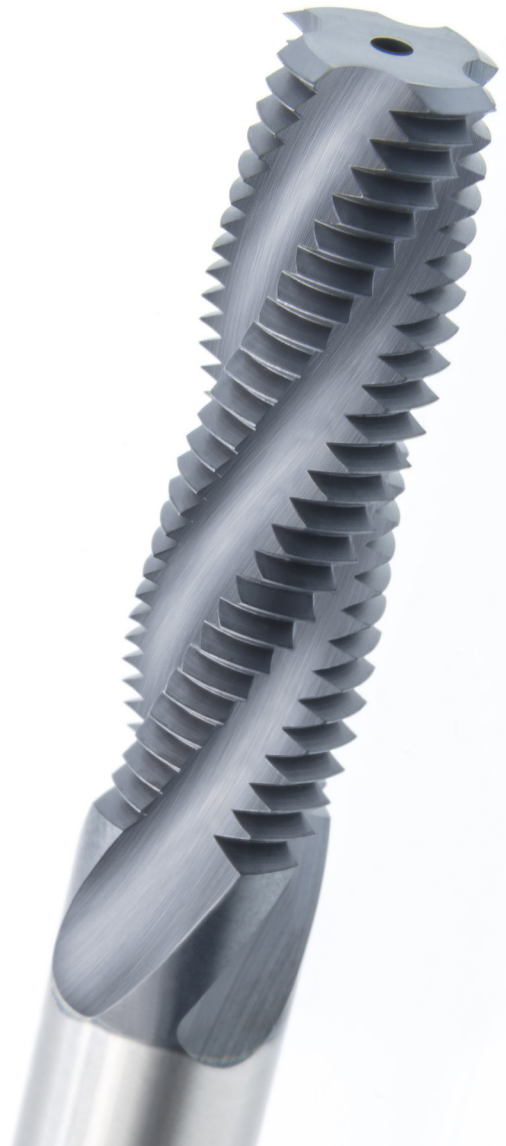



DC SWISS SA
Grand-Rue 19
CH-2735 Malleray
Tel. + 41 32 491 63 63
info@dcswiss.ch



DC Nano Tools SA
Grand-Rue 19
CH-2735 Malleray
Tel. + 41 32 491 63 63
info@dcswiss.ch

DC Swiss GmbH
Graseggerstrasse 125
DE-50737 Köln
Tel. + 49 221 995 532 0
info@dcswiss.de

DC Swiss s.r.l
Via Canova 10
IT-20017 Rho
Tel. + 39 02 669 40 41
info@dcswiss.it

DC Swiss UK Ltd
9 Orgreave Road
GB-Sheffield S13 9LQ
Tel. + 44 114 293 90 13
info@dcswiss.co.uk



dcswiss.com



WARNUNG

Gewindewerkzeuge können durch technisches Versagen oder durch Fahrlässigkeit brechen oder zersplittern und die Gesundheit des Mitarbeitenden gefährden. Befolgen Sie daher die gesetzlichen Sicherheits- und Gesundheitsvorschriften. Zudem ist das Tragen der Schutzbrille unerlässlich.

Das Schleifen von Gewindewerkzeugen verursacht gefährlichen Staub und darf nur unter gewissenhaftesten Sicherheitsrichtlinien verrichtet werden.

WARNING

Thread tools can break or shatter either through technical failure or negligence, and can endanger the health of the operator. Always obey the safety and health regulations, also the wearing of safety glasses is compulsory.

The grinding of threading tools causes hazardous particles, and must be performed only under most rigorous safety standards.

Eventuelle Änderungen oder Anpassungen der technischen Daten sowie Druckfehler berechtigen zu keinerlei Entschädigung.

Die Wiedergabe von Texten oder Bildern, auch auszugsweise, ist nicht gestattet.

We have made every effort to ensure that the information (drawings, prints, technical data) given is correct. However, we do not assume any responsibility for any errors, omissions or subsequent changes.

The reproduction of drawings and other documents and their transmission to a third party is prohibited.



THREADING SOLUTIONS

DC SWISS SA
Grand-Rue 19
CH-2735 Malleray
Tel. + 41 32 491 63 63
info@dcswiss.ch

DC Swiss GmbH
Graseggerstrasse 125
DE-50737 Köln
Tel. + 49 221 995 532 0
info@dcswiss.de

DC Nano Tools SA
Grand-Rue 19
CH-2735 Malleray
Tel. + 41 32 491 63 63
info@dcswiss.ch

DC Swiss s.r.l
Via Canova 10
IT-20017 Rho
Tel. + 39 02 669 40 41
info@dcswiss.it



DC Swiss UK Ltd
9 Orgreave Road
GB-Sheffield S13 9LQ
Tel. + 44 114 293 90 13
info@dcswiss.co.uk