

Fresas torbellino — Fresas de roscar — Calibres
Thread whirl cutters — Thread milling cutters — Thread gauges



ES-EN-ID TM.1

Catálogo
Fresas torbellino
Fresas de roscar
Calibres

ES-EN-ID TM.1

Catalogue
Thread whirl cutters
Thread milling cutters
Thread gauges





Q-TAP



180741 C11815
180760 C11830



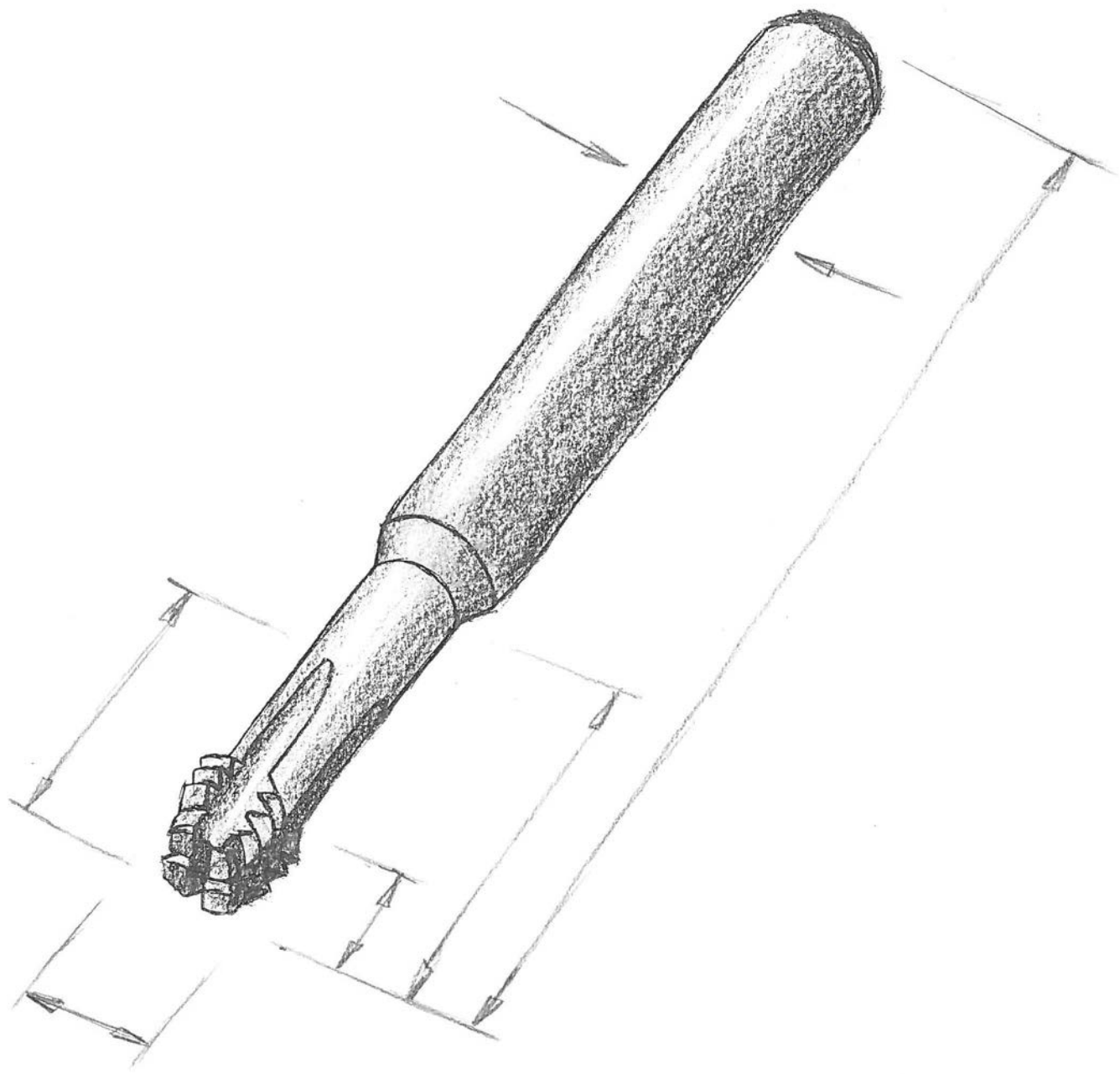

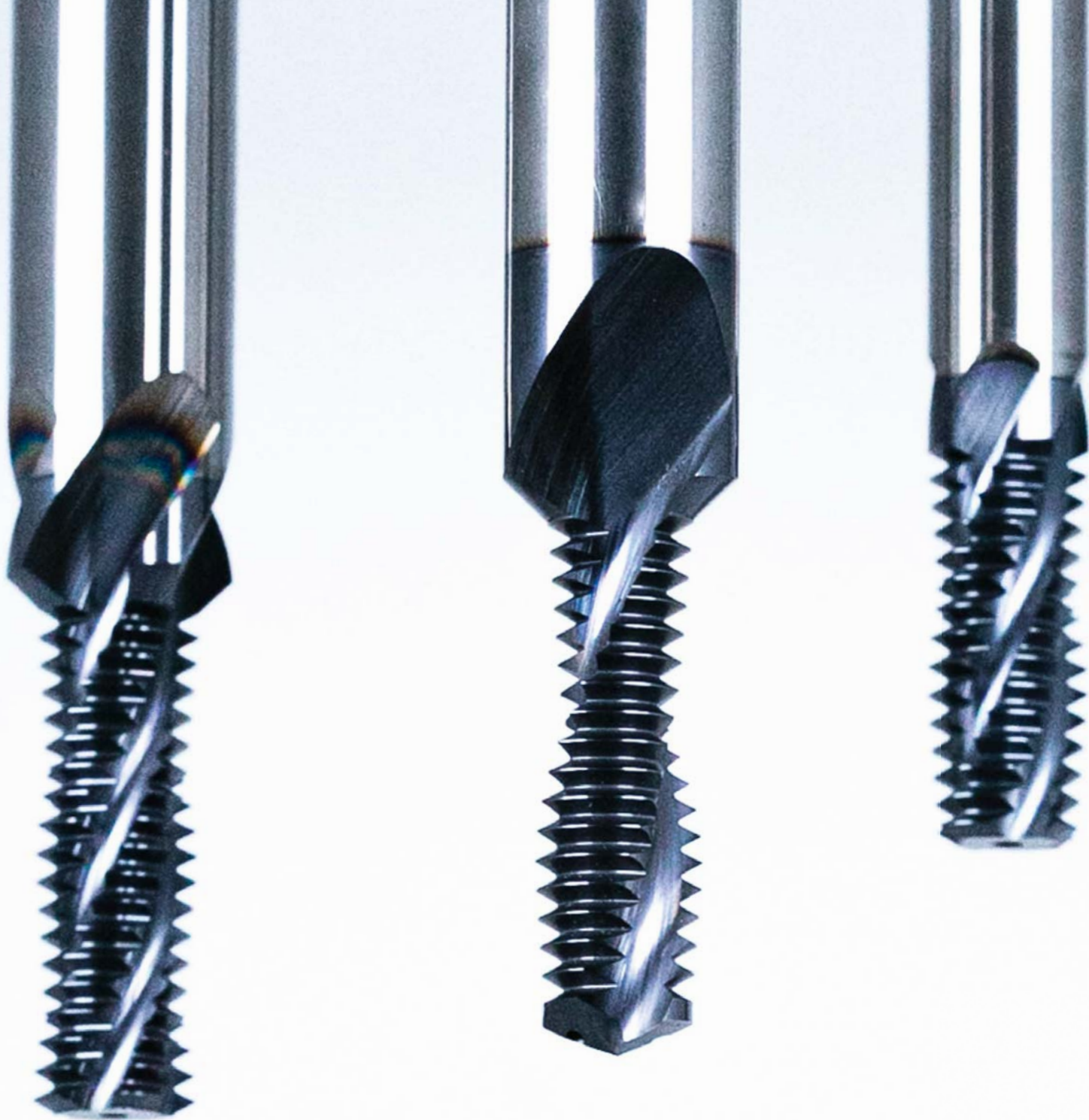

DISPONIBILIDAD DE LOS ARTICULOS

- ID *Artículos disponibles de stock*
- ID *Disponible a corto plazo*
- * ID *Artículos disponibles de stock hasta agotamiento*

AVAILABILITY OF THE ARTICLES

- ID *Stock item*
- ID *Available at short notice*
- * ID *Available from stock, while stock lasts*



Nuestra innovadora empresa está situada en el cantón de Berna en Suiza, entre la cadena montañosa del Jura y al borde del río que atraviesa nuestro valle, la Birse. Es ahí que desde 1940 nuestras herramientas de roscado de alto rendimiento se desarrollan, fabrican y se mandan a través del mundo.

Desde la fundación de nuestra empresa nos hemos centrado en optimizar todas las gamas de machos de corte y de deformación en HSSE / HSSE-PM de nuestro programa, a fin de satisfacer las necesidades de nuestros clientes, desarrollando nuevos tipos de geometrías adaptándolas a las últimas tecnologías y materiales.

En el año 2000, creamos la nueva división de producción "ONE STEP", equipada con las últimas tecnologías para el desarrollo y la producción de fresas de roscar en metal duro. En ese mismo tiempo nuestro programa "CAR" (metal duro) se desarrolló y amplió fuertemente poniendo el focus en las fresas torbellino.

Desde 2010, se ha prestado especial atención al desarrollo de nuestras micro herramientas. El resultado es un amplio programa "NANO", que incluye torbellinos, machos de corte, machos de deformación, calibres, contra-calibres en una gama de dimensión de 0.3 a 2.75 mm. Y con la acreditación ISO17025/2005, siendo DC Nano Tools SA un especialista en este mercado.

Hoy día nuestros productos de alto nivel son utilizados en el mundo entero y en todas las industrias donde **calidad**, **rendimiento** y **fiabilidad** son primordiales.

Si no encuentra lo que necesita en nuestra amplia gama de productos estándar, podemos modificar las herramientas para satisfacer sus necesidades o fabricar artículos especiales específicos, basados en sus descripciones y dibujos.

Para las preguntas a las que no puedes encontrar respuestas en nuestro catálogo, estamos encantado de estar a su entera disposición.



"Al principio, estaba buscando las mejores herramientas, entonces decidí de producirlas yo mismo"

Daniel Charpilloz – 1940



Our innovative SME is at home in the Berner Jura in Switzerland, idyllically nestled between hills and on the banks of the still young river called Birs. This is where since 1940 the high-performance threading tools of our brand DC are developed, manufactured and supplied all over the world.

Since the foundation of our company, we have focused on expanding our range of HSSE / HSSE-PM taps and thread formers in order to optimally meet our customers' needs and on constantly developing new tool types for the latest technologies and materials.

In 2000, we created the new "ONE STEP" production division, equipped with the latest production technologies, for the development and manufacture of reliable and powerful solid carbide thread milling cutters. In the meantime, our CAR programme has been greatly developed and expanded, with a focus on thread whirling cutters.

Since 2010, special attention has been paid to the development of our micro tools. The result is our in the meantime really broad "nano" programme, which includes thread whirlers, taps, thread formers, thread gauges and check thread gauges in the diameter range from 0.3 - 2.75 mm. As an ISO 17025/2005 accredited company, DC Nano Tools SA is your specialist in this field.

Today, our high performance threading tools are used worldwide and in all industries where **quality, performance** and **reliability** of the products are paramount.

If you do not find what you need in our wide range of standard products, we can modify tools to suit your needs or manufacture specific special items, based on your specifications and drawings.

For questions, to which you cannot find an answer in our catalogue, we are of course gladly at your entire disposal.



"In the beginning, I was looking for the best tools, then I decided to produce them myself"

Daniel Charpilloz – 1940

DC SWISS EN EL MUNDO ENTERO Y SIEMPRE A SU LADO

PROXIMIDAD A LOS CLIENTES

Encontrareis siempre un interlocutor competente, ya sea en la oficina central en Suiza, en una de sus sucursales de Alemania, Italia o Inglaterra o a través de sus numerosos partners tecnológicos o distribuidores alrededor del mundo.

CUSTOMER PROXIMITY

You will always find a competent contact person, whether at our main site in Switzerland, at one of our subsidiaries in Germany, Italy and England, or at one of our many representatives or resellers worldwide.

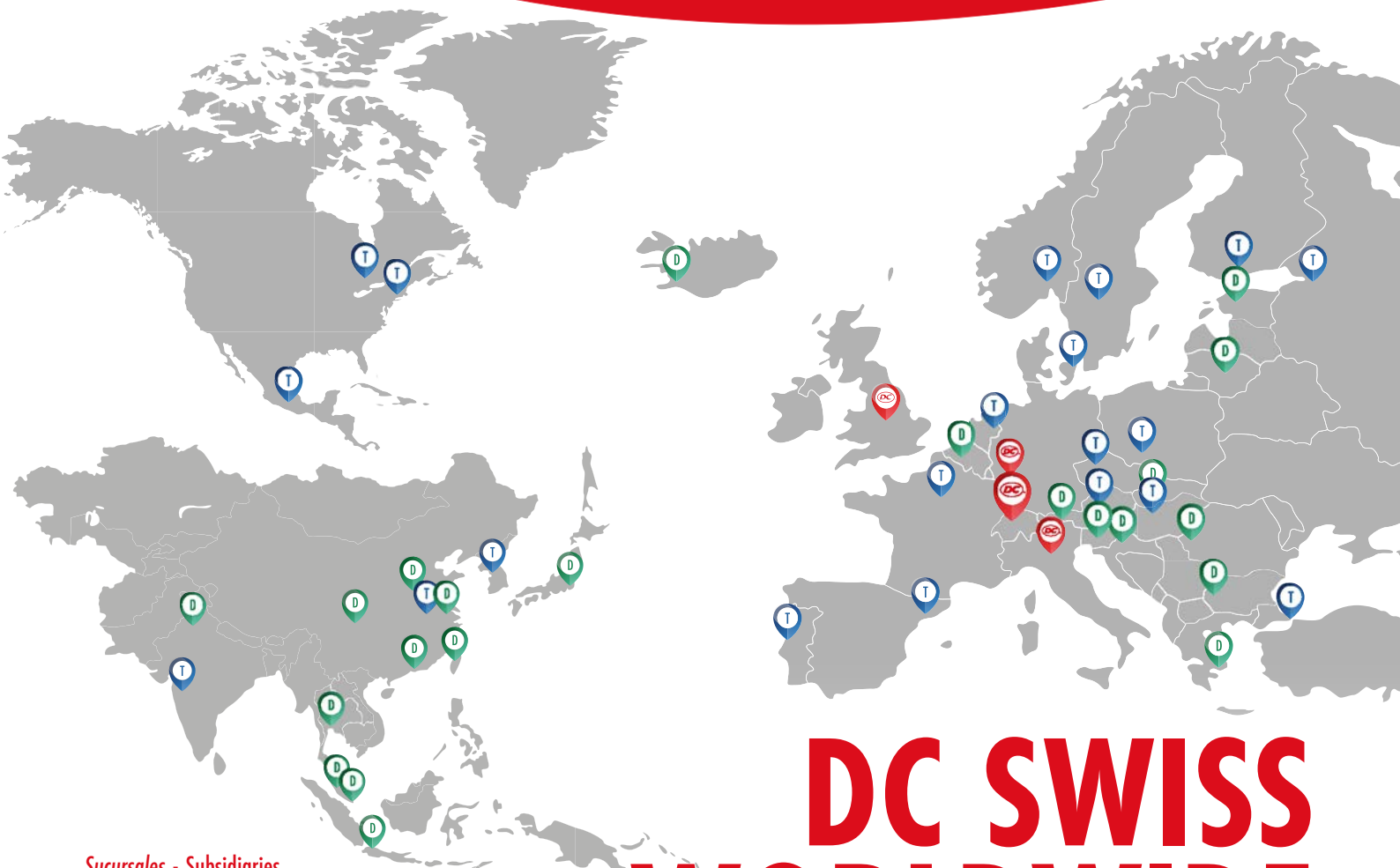

Sucursales - Subsidiaries

Partners tecnológicos - Technology Partners

Agencias - Distributors

Para los otros países : dcswiss.com/es/red-de-ventas

For further countries: : dcswiss.com/en/sales-network

DC SWISS WORLDWIDE

AND ALWAYS CLOSE TO YOU

SWISS QUALITY

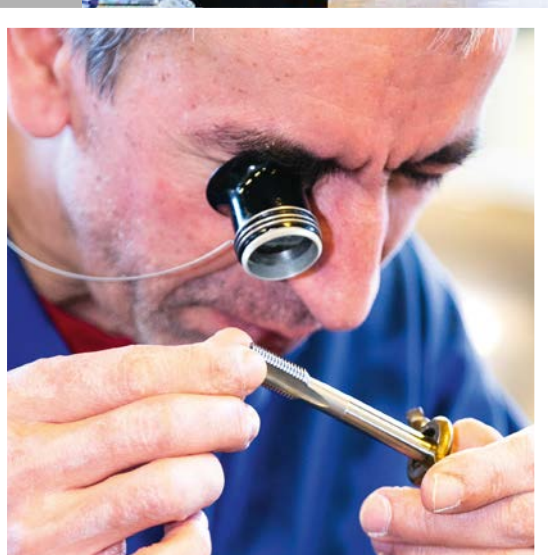

100 % made by DC SWISS - *Garantía desde el desarrollo de la herramienta a su fabricación y control final, gracia a nuestra peritación y a nuestra competencia en todos los dominios de producción de herramientas.*

100 % made by DC SWISS - guaranteed from the development of the tool to its production and straight through to the end control, thanks to our know-how and competencies in the whole field of threading tool manufacturing.

NUESTROS VALORES

RESULTADO

El resultado esta al centro de nuestras preocupaciones para el desarrollo de soluciones personalizadas y mejoras de nuestros productos estándar a las necesidades del cliente. Damos gran importancia en ofrecer la mejor relación calidad/precio como base de una relación de confianza con nuestros clientes.

OUR VALUES

PERFORMANCE

We make every effort to develop new high-performance threading tools and to adapt the performance of our standard tools to the current needs of our customers. We attach great importance to a constant price/performance ratio as the basis for a trusting relationship with our customers.



**AUTOMOCIÓN
AUTOMOTIVE**

**INDUSTRIA RELOJERA
WATCHMAKING**

**AVIACIÓN Y AEROESPACIAL
AEROSPACE**

**TECNOLOGÍA MEDICAL
MEDICAL**

**SOLUCIONES PERSONALIZADAS
CUSTOMISED SOLUTIONS**



CONOCIMIENTO

El valor de nuestro Saber Hacer se traduce por una manera unica de resolver problemas y de asociar el conjunto de conocimientos, experiencias y competencia acumuladas desde 1940.

KNOW-HOW

The value of our know-how represents in a unique way the solving of problems and articulates, implements and associates the whole knowledge, experiences and competences accumulated since 1940.

FIABILIDAD

Relaciones a largo plazo se construyen unicamente sobre base de confianza, transparencia y compromisos cotidiano de cada uno de nuestros colaboradores a suministrar a nuestros clientes herramientas y servicios de maxima calidad.

RELIABILITY

We know that lasting relationships can only be built on the basic of confidence, transparency and the daily efforts of each of our employees to provide our customers with tools and services of an excellent quality.





ROSCADO CLÁSICO
THREAD CUTTING



ROSCADO POR LAMINACIÓN
THREAD FORMING



AVIACIÓN Y AEROSPAECIAL
AEROSPACE



ROSCADO POR INTERPOLACIÓN
THREAD MILLING



AUTOMOCIÓN
AUTOMOTIVE



TECNOLOGÍA MÉDICA
MEDICAL



SOLUCIONES PERSONALIZADAS
CUSTOMISED SOLUTIONS

PRODUCCIÓN DE ENERGÍA
POWER GENERATION



INDUSTRIA RELOJERA
WATCHMAKING



MECÁNICA GENERAL
GENERAL ENGINEERING

TORBELLINO
THREAD WHIRLING



CALIBRES DE CONTROL
THREAD GAUGES



MANDRIL DE ROSCAR
TAPPING CHUCKS



COJINETES DE ROSCAR
DIES



NUESTRAS COMPETENCIAS

SERVICIO DE MEDICIÓN Y DE METROLOGÍA

DC SWISS dispone de un laboratorio metrológico acreditado por el Servicio Suizo de Acreditación como laboratorio de calibración de dimensiones.

DC SWISS está capacitada para ofrecer servicios de calibración y metrología para conexiones roscadas.

Un certificado es la confirmación por escrito de la calidad del equipo metrológico de una empresa. DC NANO TOOLS SA (acreditación SCS 0143), miembro del Grupo DC SWISS, puede inspeccionar y calibrar calibres tampón, así como los Masters para medición de anillos de rosca de acuerdo con la norma internacional ISO 17025.

Nuestras herramientas son el resultado de numerosos estudios. Los diseñamos usando todo el conocimiento que hemos adquirido durante muchos años, siempre poniéndolos a prueba hasta sus máximos límites. Compartimos todo este conocimiento con usted gracias a los diferentes servicios que les ofrecemos. Nuestro objetivo es proporcionar la solución más adecuada en cada caso, desde el estudio de viabilidad hasta la producción en serie.

Somos expertos en todos los aspectos del proceso de roscado y somos capaces de ofrecerle nuestra experiencia de montaje desde el diseño, mecanizado e inspección metrológica a través de las diversas etapas de la creación de conexiones roscadas.

Expertos en diseños

Cada diseño es único pero a menudo hay múltiples soluciones. Podemos asesorarle sobre qué tipo de fijación elegir, por ejemplo, ajustable, auto bloqueo, o roscados de alta calidad. Durante la fase de elaboración, podemos ayudar a sus ingenieros a identificar y decidir la mejor conexión roscada en términos de dimensiones, practicidad, costes de producción y montaje.

Experiencia en mecanizado

Cada herramienta requiere una programación especial con numerosos parámetros. Podemos ayudarle a sacar lo mejor de sus máquinas y herramientas para lograr el máximo rendimiento a través de una programación personalizada. Y si una herramienta lo precisa, podemos hacerlo para que cumpla con todos sus requisitos. A menudo, un enfoque particular del ajuste permite resolver un problema causado por geometría compleja o posicionamiento inusual.

Experiencia en metrología

Suministramos un gran número de medidores y también asesoramiento sobre cómo utilizarlos e inspeccionarlos para garantizar que la calidad requerida se alcanza de manera adecuada. Otras medidas más específicas están disponibles, como la concentricidad así como todas las medidas de certificación. Podemos ayudarle a establecer procedimientos de control. Este servicio está disponible para diámetros de flanco de 0.1 à 3.0 mm, y diámetros externos de 0.1 à 3.5 mm. Confíe en la experiencia de DC NANO TOOLS SA para calibrar sus herramientas de medición.

Formación

En nuestro centro de aplicación y laboratorio, distribuimos información completa y asesoramiento sobre las mejores prácticas a todos nuestros clientes en el diseño, la fabricación y el funcionamiento de fijaciones roscadas. Podemos proporcionar formación bajo demanda en temas específicos como fijaciones seguras.

OUR EXPERTISE

CALIBRATION & METROLOGY SERVICE

DC SWISS has a metrology lab that is accredited by the Swiss Accreditation Service as a laboratory for calibrating lengths.

DC SWISS is able to offer a calibration and metrology service for screw connections.

A certificate is written confirmation of the quality of a company's metrological equipment. DC NANO TOOLS SA (SCS accreditation 0143), a member of the DC SWISS Group, can inspect and calibrate thread plug gauges as well as thread ring gauges in accordance with the ISO 17025 international standard.

Our tools are the result of numerous studies. We design them using all the knowledge we have acquired over many years, always testing them to their utmost limits. We share all this knowledge with you in the form of our services. Our aim is to provide the most appropriate solution in each case, from feasibility study right through to mass production.

We are experts in all aspects of the process of screw threading, and are able to offer you our assembly expertise from design, machining and metrological inspection through the various stages of creating screw connections.

Design expertise

Each design is unique, but there are often multiple solutions. We can advise you on which type of screw fixing to choose, for example adjustable, self-locking or high-quality screws. During the design phase, we can help your designers to identify and decide the best-performing screw fixing in terms of dimensions, practicality, production costs and assembly.

Machining expertise

Each tool calls for special programming involving numerous parameters. We can help you to get the best out of your machines and tools in order to achieve maximum performance via personalised programming. We can provide you with support in the inspection and measurement phase, so you can be sure of having produced the screw thread you were expecting. And if a tool needs to be customised, we can do this so that it meets all your requirements. Often, a particular approach to fitting makes it possible to resolve a problem caused by complex geometry or unusual positioning.

Metrological expertise

We supply a large number of measuring gauges and also advice on how to use and inspect them in order to ensure the required quality is consistently achieved. Other more specific measures are available, such as concentricity and certification measures. We can assist you in setting up control procedures. This service is available for pitch diameters of 0.1 to 3.0 mm, and external diameters of 0.1 to 3.5 mm. Don't take the risk – benefit from the expertise of DC NANO TOOLS SA to calibrate your measuring tools.

Training

In our application centre and our laboratory, we distribute full information and advice on best practice to all our customers in the design, manufacture and use of screw fixings. We can provide on-demand training in specific subjects such as secure fixings.



The management system of

DC Swiss SA

CP 363,
Grand rue 19
CH - 2735 Malleray



has been assessed and certified as meeting the requirements of

ISO 9001:2015

For the following activities

Design, development, manufacturing, marketing, sales and distribution of cutting tools. Expertise in threading technology.

This certificate is valid from 19 June 2018 until 18 June 2021
and remains valid subject to satisfactory surveillance audits
Recertification audit due before 7 June 2021
Issue 6. Certified since September 2007



Authorised by



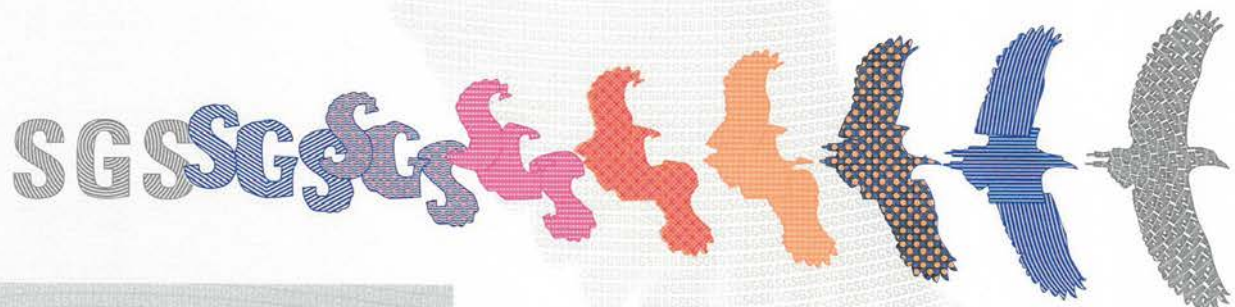



SGS Société Générale de Surveillance SA
Technoparkstrasse 1 8005 Zurich Switzerland
t +41 (0)44 445-16-80 f +41 (0)44 445-16-88 www.sgs.com











REGISTRO — REGISTER

	Torbellino Thread whirling		Roscado por interpolación Thread milling																																																																																																																				
<p>M</p> <table border="0"> <tr><td>GW1000</td><td>44</td><td>GW2000</td><td>47</td></tr> <tr><td>GW3000</td><td>50</td><td>GWi3000</td><td>65</td></tr> <tr><td>GWi5000</td><td>82</td><td>GWH3000</td><td>89</td></tr> <tr><td>ZBGF</td><td>90</td><td></td><td></td></tr> </table> <p>MJ</p> <table border="0"> <tr><td>GWi3000</td><td>67</td><td></td><td></td></tr> </table> <p>MF</p> <table border="0"> <tr><td>GW3000</td><td>53</td><td>GWi3000</td><td>69</td></tr> </table> <p>MJF</p> <table border="0"> <tr><td>GWi3000</td><td>71</td><td></td><td></td></tr> </table> <p>UNC</p> <table border="0"> <tr><td>GW3000</td><td>56</td><td>GWi3000</td><td>73</td></tr> <tr><td>GWi5000</td><td>83</td><td>ZBGF</td><td>91</td></tr> </table> <p>UNJC</p> <table border="0"> <tr><td>GWi3000</td><td>75</td><td></td><td></td></tr> </table> <p>UNF</p> <table border="0"> <tr><td>GW3000</td><td>59</td><td>GWi3000</td><td>77</td></tr> <tr><td>GWi5000</td><td>84</td><td>ZBGF</td><td>92</td></tr> </table> <p>UNJF</p> <table border="0"> <tr><td>GWi3000</td><td>79</td><td></td><td></td></tr> </table> <p>S</p> <table border="0"> <tr><td>GW1000</td><td>45</td><td>GW2000</td><td>48</td></tr> <tr><td>GW3000</td><td>62</td><td>GWi3000</td><td>81</td></tr> <tr><td>GWi5000</td><td>85</td><td></td><td></td></tr> </table> <p>SL</p> <table border="0"> <tr><td>GW1000</td><td>46</td><td>GW2000</td><td>49</td></tr> <tr><td>GW3000</td><td>62</td><td></td><td></td></tr> </table>		GW1000	44	GW2000	47	GW3000	50	GWi3000	65	GWi5000	82	GWH3000	89	ZBGF	90			GWi3000	67			GW3000	53	GWi3000	69	GWi3000	71			GW3000	56	GWi3000	73	GWi5000	83	ZBGF	91	GWi3000	75			GW3000	59	GWi3000	77	GWi5000	84	ZBGF	92	GWi3000	79			GW1000	45	GW2000	48	GW3000	62	GWi3000	81	GWi5000	85			GW1000	46	GW2000	49	GW3000	62			<p>M</p> <table border="0"> <tr><td>GF</td><td>104 / 115</td><td>GFH</td><td>104</td></tr> <tr><td>GFS</td><td>117</td><td>GFM</td><td>128</td></tr> <tr><td>BGF</td><td>132</td><td></td><td></td></tr> </table> <p>MF</p> <table border="0"> <tr><td>GF</td><td>107 / 115</td><td>GFS</td><td>120</td></tr> <tr><td>GFM</td><td>128</td><td>BGF</td><td>135</td></tr> </table> <p>UNC, UNF, UNEF, UN, UNS</p> <table border="0"> <tr><td>GF</td><td>109 / 116</td><td>GFS</td><td>122</td></tr> <tr><td>GFM</td><td>129</td><td></td><td></td></tr> </table> <p>G (BSP)</p> <table border="0"> <tr><td>GF</td><td>113</td><td>GFS</td><td>126</td></tr> <tr><td>GFM</td><td>130</td><td></td><td></td></tr> </table> <p>NPT, NPTF</p> <table border="0"> <tr><td>GF</td><td>114</td><td>GFS</td><td>127</td></tr> <tr><td>GFM</td><td>131</td><td></td><td></td></tr> </table>		GF	104 / 115	GFH	104	GFS	117	GFM	128	BGF	132			GF	107 / 115	GFS	120	GFM	128	BGF	135	GF	109 / 116	GFS	122	GFM	129			GF	113	GFS	126	GFM	130			GF	114	GFS	127	GFM	131		
GW1000	44	GW2000	47																																																																																																																				
GW3000	50	GWi3000	65																																																																																																																				
GWi5000	82	GWH3000	89																																																																																																																				
ZBGF	90																																																																																																																						
GWi3000	67																																																																																																																						
GW3000	53	GWi3000	69																																																																																																																				
GWi3000	71																																																																																																																						
GW3000	56	GWi3000	73																																																																																																																				
GWi5000	83	ZBGF	91																																																																																																																				
GWi3000	75																																																																																																																						
GW3000	59	GWi3000	77																																																																																																																				
GWi5000	84	ZBGF	92																																																																																																																				
GWi3000	79																																																																																																																						
GW1000	45	GW2000	48																																																																																																																				
GW3000	62	GWi3000	81																																																																																																																				
GWi5000	85																																																																																																																						
GW1000	46	GW2000	49																																																																																																																				
GW3000	62																																																																																																																						
GF	104 / 115	GFH	104																																																																																																																				
GFS	117	GFM	128																																																																																																																				
BGF	132																																																																																																																						
GF	107 / 115	GFS	120																																																																																																																				
GFM	128	BGF	135																																																																																																																				
GF	109 / 116	GFS	122																																																																																																																				
GFM	129																																																																																																																						
GF	113	GFS	126																																																																																																																				
GFM	130																																																																																																																						
GF	114	GFS	127																																																																																																																				
GFM	131																																																																																																																						
	Brocas de centrages, Brocas helicoidales Spotting drills, Twist drills																																																																																																																						
<table border="0"> <tr><td>C315VS</td><td>86</td><td></td><td></td></tr> <tr><td>FZ315VS</td><td>87</td><td></td><td></td></tr> <tr><td>F286VS</td><td>88</td><td></td><td></td></tr> </table>				C315VS	86			FZ315VS	87			F286VS	88																																																																																																										
C315VS	86																																																																																																																						
FZ315VS	87																																																																																																																						
F286VS	88																																																																																																																						

REGISTRO — REGISTER









































	Calibres tampón de roscas Thread plug gauges		Calibres anillos de roscas Thread ring gauges
M D5701-1 138 D5701-2 138 D5703 138		M D5704 139 D5714 139	
MF D5701-1 140 D5701-2 141 D5703 140		MF D5704 142 D5714 142	
UNC D5701-1 144 D5703 144		UNC D5704 144 D5714 144	
UNF D5701-1 145 D5703 145		UNF D5704 145 D5714 145	
UNEF D5703 145		UNEF D5704 145 D5714 145	
G D5701-1 146 D5701-2 146 D5703 146		G D5704 146 D5714 146	
PG D5725 146		PG D5704 146	
NPT, NPTF D5720 147		NPT, NPTF D5721 147	
EG M, EG UNC, EG UNF D5703 148			
M nano DN01 158 DN02 158		M nano DZ04 164 DZ14 164 DN04 169 DN14 169	
MF nano DN01 159 DN02 159		MF nano DZ04 165 DZ14 165 DN04 170 DN14 170	
UNC nano DN01 160 DN02 160		UNC nano DZ04 166 DZ14 166 DN04 171 DN14 171	
UNF nano DN01 160 DN02 160		UNF nano DZ04 166 DZ14 166 DN04 171 DN14 171	
S nano DN01 161 DN02 161		S nano DZ04 167 DZ14 167 DN04 172 DN14 172	
SF nano DN01 163 DN02 163		SF nano DZ04 168 DZ14 168 DN04 173 DN14 173	
SL nano DN01 163 DN02 163			
 <i>Todos los calibres tampón de rosca nano disponen de certificados SCS de pago, disponible sobre pedido.</i> All nano thread plug gauges are SCS-certified and the paid certificate is available on request.		 <i>Todos los calibres anillos nano estan acompañados de un certificado de control, hecho con contracalibres tampons certificados SCS. El certificado de control de pago es disponible sobre pedido.</i> All nano ring gauges have a certificate of measurement, established with SCS certified plug check gauges. The paid certificate is available on request.	

REGISTRO — REGISTER















	<p>Contra calibre Thread plug check gauges</p>		<p>Patrón roscado Calibration thread plug gauges</p>
<p>M nano RN05-1 174 RN15-1 174 RN05-2 179 RN15-2 179</p> <p>MF nano RN05-1 175 RN15-1 175 RN05-2 180 RN15-2 180</p> <p>UNC nano RN05-1 176 RN15-1 176 RN05-2 181 RN15-2 181</p> <p>UNF nano RN05-1 176 RN15-1 176 RN05-2 181 RN15-2 181</p> <p>S nano RN05-1 177 RN15-1 177 RN05-2 182 RN15-2 182</p> <p>SF nano RN05-1 178 RN15-1 178 RN05-2 183 RN15-2 183</p> <p> <i>Certificado SCS incluido.</i> SCS certificate included.</p>		<p>S nano EN00 186</p> <p> <i>Certificado SCS incluido.</i> SCS certificate included.</p> <p></p> <p><i>Calibres nano - Equipamiento de control - certificado SCS</i> <i>Formulario de pedido para calibres nano</i> <i>Micro-Safelock</i></p> <p><i>Tabla de dureza</i> <i>Pulgadas - mm</i> <i>Tabla de conversión</i> <i>Diámetro del agujero</i> <i>Diámetro de torneado</i> <i>Cuestionario técnico</i> <i>Condiciones de entrega</i></p> <p>Encontrará más información en www.dcswiss.com</p>	
	<p>Testimonio de desgaste Master plug gauges WEAR</p>		
<p>M nano RN05-3 184 RN15-3 184</p> <p>MF nano RN05-3 185 RN15-3 185</p> <p> <i>Certificado SCS incluido.</i> SCS certificate included.</p>		<p>nano-Thread gauges - Inspection devices - SCS Measurement certificate Order form for nano thread gauges Micro-Safelock</p> <p>Hardness chart Chart inches - mm Conversion table Core holes Turned diameters Technical questionnaire Delivery and payment conditions</p> <p>Further information are available on www.dcswiss.com</p>	















PICTOGRAMAS — PICTOGRAPHS

Fresas torbellino, fresas de roscar, fresas de taladrar/roscar, brocas de centrar y de taladrar en metal duro integral
Solid carbide thread whirl cutters, thread milling cutters, thrillers, circular drill thread milling cutters, spotting drills and twist drills

	Metal duro integral Solid carbide		Lubrificación interna mínima 20 bars Internal coolant min. 20 bar
	Recubrimiento de protección contra el desgaste "VS" para uso general DC "VS" wear-protective coating for general use		Canal de lubricación interna Internal cooling channel
	Recubrimiento de protección "VX" para aceros inoxidables y aleaciones de Ni DC "VX" wear-protective coating for stainless steels and Nickel alloys		Canal de lubricación interna (BGF, 2 ranuras) Internal cooling channel (BGF, 2 flutes)
	Recubrimiento resistente "VH" para aceros templados (≤ 63 HRC) DC "VH" wear-protective coating for tempered steels (≤ 63 HRC)		Canal de lubricación interna (BGF, 3 ranuras) Internal cooling channel (BGF, 3 flutes)
	Norma de la industria relojera suiza Norm of Swiss Watch Industry		Ranuras helicoidales con hélice a 10° a derecha 10° right-hand spiral flutes
	Para materiales ≤ 63 HRC (GWH - GFH) For materials ≤ 63 HRC (GWH - GFH)		Ranuras helicoidales con hélice a 15° a derecha 15° right-hand spiral flutes
	Tolerancia del mango h5 / h6 Shank tolerance h5 / h6		Ranuras helicoidales con hélice a 27° a derecha 27° right-hand spiral flutes
	Tolerancia del mango h5 Shank tolerance h5		Ranuras helicoidales con hélice a 27° a derecha 27° right-hand spiral flutes
	Tolerancia del mango h6 Shank tolerance h6		0° ángulo de hélice (GWi5000 - GWH) 0° helix angle (GWi5000 - GWH)
	Coaxialidad Shape accuracy		10° ángulo de hélice a derecha 10° right-hand helix angle
	Mecanizado HSC HSC-Machining		3° ángulo de hélice a izquierda (ZBGF) 3° left-hand helix angle (ZBGF)
	GW1000 perfil GW1000 profile		Con corte de chablán a 45° With 45° chamfer for countersinking
	GW2000 perfil GW2000 profile		Radio en el diámetro exterior Radius on external diameter
	GW3000 perfil GW3000 profile		Canal de lubricación interna GWi $\varnothing 0.8 - \leq 6.35$ mm Cooling channel GWi $\varnothing 0.8 - \leq 6.35$ mm
	GWi3000 perfil GWi3000 profile		Canal de lubricación interna GWi $\varnothing > 6.35 - \leq 20$ mm Cooling channel GWi $\varnothing > 6.35 - \leq 20$ mm
	GWi5000 perfil GWi5000 profile		Rosca cónica 1:16 (NPT - NPTF) Tapered thread 1:16 (NPT - NPTF)
	Numero de diente para la programación (GWi5000) Number of teeth for programming (GWi5000)		Longitud roscada $2 \times D_1$ Thread length $2 \times D_1$
	Para roscados sin rebabas (GWi5000) For burr-free threads (GWi5000)		Longitud roscada $2.5 \times D_1$ Thread length $2.5 \times D_1$
	Perfil de la fresa de taladro circular Circular drill thread milling cutter profile		Longitud roscada $3 \times D_1$ Thread length $3 \times D_1$
	Fresa de taladro circular con canal de lubricación Circular drill thread milling cutter with cooling channel		Longitud roscada $4 \times D_1$ Thread length $4 \times D_1$

PICTOGRAMAS — PICTOGRAPHS

	Longitud roscada 1.5 x D ₁ Thread length 1.5 x D ₁
	Longitud roscada 2 x D ₁ Thread length 2 x D ₁
	Longitud roscada 2.5 x D ₁ Thread length 2.5 x D ₁
	Rosca interior Internal thread
	Rosca exterior External thread
	Rosca interior (GW - GWi - GWH) Internal thread (GW - GWi - GWH)
	Para agujero ciego (BGF) Blind holes (BGF)
	Para agujero pasante (BGF) Through holes (BGF)
	BGF, 2 ranuras BGF, 2 flutes
	BGF, 3 ranuras BGF, 3 flutes
	Rosca EG Thread EG (for wire screw thread inserts)
	Diámetro del agujero Core-hole diameter
	Número de ranuras (Z) Number of flutes (Z)
	Sentido de rotación a izquierda Sense of rotation of tool "left"

	Sobre pedido On request
	Quitar el diente incompleto (GF61 - GFH61), conversión a la nueva versión en curso Removal of incomplete thread (GF61 - GFH61), change to new version in progress
	Ángulo de chaflán 90° Chamfer 90°
	Profundidad de taladrado 5 x d ₁ Drilling depth 5 x d ₁
	Profundidad de taladrado 6 x d ₁ Drilling depth 6 x d ₁
	Profundidad de taladrado 8 x d ₁ Drilling depth 8 x d ₁
	Perforación con desahogo Drilling with pecking
	Ángulo de punta a 130° 130° point angle
	Ángulo de punta a 140° 140° point angle
	Ranuras helicoidales con hélice a 30° a derecha 30° right-hand spiral flutes
	Refrigeración interna, con 2 salidas frontales Internal coolant, with 2 frontal outflows
	Refrigeración interna, con 2 canales en espiral Internal coolant, with 2 twisted coolant channels
	Para profundidad de taladrado 3 x d ₁ For drilling depth 3 x d ₁
	Para profundidad de taladrado 5 x d ₁ For drilling depth 5 x d ₁



Dimensiones de construcción según norma de fábrica DC
General dimensions as per DC standards



Dimensiones del mango según DIN 6535 HA
Shank dimensions as per DIN 6535 HA

Nota GFM

 Para evitar de recortar el perfil, el diámetro de la fresa no deberá superar $\frac{2}{3}$ del diámetro a realizar para los pasos estándar y $\frac{3}{4}$ para los pasos finos.

Notice GFM

 In order to avoid profile defects it is important that the tool diameter does not exceed $\frac{2}{3}$ of the diameter of the work-piece thread for coarse threads ($\frac{3}{4}$ for fine threads).

CODIFICACIÓN — CODIFICATION

DC Fresas torbellino en metal duro integral

DC Solid carbide thread whirl cutters

Ejemplo - Example



Ejecución estándar	Standard execution	GW				
Para aceros templados (55 - ≤ 63 HRC)	For hardened steels (55 - ≤ 63 HRC)	GWH				
Con canal de refrigeración	With cooling channel	GWi				
Un diente	Single tooth		11			
Multi-diente a un perfil	Single profile, multi toothed		20			
Multi-diente a doble perfil	Double pitch with multi flutes		30			
Multi-diente con perfil completo	Multi fluted with full profile		50			
Lubricación exterior	External lubrication			1		
Lubricación interior	Internal lubrication			6		
Longitud roscada 2 x D _i	Thread length 2 x D _i				5	
Longitud roscada 2.5 x D _i	Thread length 2.5 x D _i				6	
Longitud roscada 3 x D _i	Thread length 3 x D _i				7	
Longitud roscada 4 x D _i	Thread length 4 x D _i				9	
Protección contra el desgaste "VS" para uso general	VS wear-protective coating, general					VS
Protección "VX" para aceros inoxidables y aleaciones de Ni	VX coating for stainless steels and Nickel alloys					VX
Protección "VH" para aceros templados (≤ 63 HRC)	VH coating for hardened steels (≤ 63 HRC)					VH
Ejecución especial	Special execution					SP

DC Fresa de taladrar/rosca circular en metal duro integral

DC Solid carbide circular drill thread milling cutters

Ejemplo - Example



Ejecución estándar	Standard execution	ZBGF				
Ranuras helicoidales con hélice a 3° a izquierda	Spiral flutes 3°		60			
Lubricación interior	Internal lubrication			6		
Longitud roscada 2 x D _i	Thread length 2 x D _i				5	
Longitud roscada 3 x D _i	Thread length 3 x D _i				7	
Protección contra el desgaste "VS" para uso general	VS wear-protective coating, general					VS
Ejecución especial	Special execution					SP

CODIFICACIÓN — CODIFICATION

DC Fresas de roscar en metal duro integral

DC Solid carbide thread milling cutters

Ejemplo - Example



Ejecución estándar	Standard execution			GF		
Para aceros templados (55 - ≤ 63 HRC)	For hardened steels (55 - ≤ 63 HRC)			GFH		
Con corte de chaflán a 45°	With 45° chamfer for countersinking			GFS		
Fresa de roscar polivalente	For multi sizes thread milling cutters			GFM		
Fresa de taladrar/roscar	Thrillers			BGF		
Helicoidal 27° (GF61), 10° (GFH)	Spiral flutes 27° (GF61), 10° (GFH)				61	
Helicoidal 15° (GF62, GFM62)	Spiral flutes 15° (GF62, GFM62)				62	
Helicoidal 27° (GFS)	Spiral flutes 27°(GFS)				66	
Fresa de taladrar/roscar 2 ranuras	Thrillers 2 flutes				67	
Fresa de taladrar/roscar 3 ranuras	Thrillers 3 flutes				68	
Lubricación exterior	External lubrication				1	
Lubricación interior	Internal lubrication				6	
Longitud roscada 1.5 x D ₁	Thread length 1.5 x D ₁					0
Longitud roscada 2 x D ₁	Thread length 2 x D ₁					5
Longitud roscada 2.5 x D ₁	Thread length 2.5 x D ₁					6
Protección contra el desgaste "VS" para uso general	VS wear-protective coating, general					VS
Protección "VX" para aceros inoxidables y aleaciones de Ni	VX coating for stainless steels and Nickel alloys					VX
Protección "VH" para aceros templados (≤ 63 HRC)	VH coating for hardened steels (≤ 63 HRC)					VH
Ejecución especial	Special execution					SP
Perfil adaptado a la rosca exterior	Profile for external threads					EX

Nota GFM



Para evitar de recortar el perfil, el diámetro de la fresa no deberá superar $\frac{2}{3}$ del diámetro a realizar para los pasos estándar y $\frac{3}{4}$ para los pasos finos.

Notice GFM



In order to avoid profile defects it is important that the tool diameter does not exceed $\frac{2}{3}$ of the diameter of the work-piece thread for coarse threads ($\frac{3}{4}$ for fine threads).

CLASIFICACIÓN DE LOS MATERIALES

Ejemplos prácticos de clasificación de los materiales

11 Aceros de decoletaje 1.0711 9S20 1.0715 9SMn28 1.0718 9SMnPb28 1.0726 3SS20 1.0737 9SMnPb36	12 Aceros de construcción o de cementación 1.0037 S137-2 (S235JR) 1.0050 S150-2 (E295) 1.0060 S160-2 (E335) 1.5919 15CrNi6 1.7131 16MnCr5	13 Aceros al carbón 1.0503 C45 1.0535 C55 1.0601 C60 1.1545 C105W1 1.2067 102Cr6 (100Cr6)	14 Aceros aleados < 850 N/mm ² 1.2363 X100CrMoV5-1 1.3551 80MoCrV42-16 1.7218 25CrMo4 1.7220 34CrMo4 1.7225 42CrMo4	15 Aceros aleados/trat. > 850 - < 1150 N/mm ² 1.3553 X82WMoCrV6-5-4 1.6580 30CrNiMo8 1.7220 34CrMo4 1.7225 42CrMo4 1.8507 34CrAlMo5
16 Aceros de alta resistencia ≤ 44 HRC EN-GJS-1200-2 1.6582 34CrNiMo6v 1.7225 42CrMo4v 1.7228 50CrMo4v 1.8515 31CrMo12v	17 Aceros templados y revenidos > 44 - ≤ 54 HRC > 44 - ≤ 54 HRC	18 Aceros templados > 54 - ≤ 63 HRC > 54 - ≤ 63 HRC	21 Aceros inoxidables al azufre 1.4005 X12CrS13 1.4104 X14CrMoS17 1.4305 X10CrNiS18-9	22 Austeníticos 1.4301 X5CrNi18-10 1.4406 X2CrNiMoN17-12-2 1.4435 X2CrNiMo18-14-3 1.4541 X6CrNiTi18-10 1.4571 X6CrNiMoTi17-12-2
23 Ferríticos y martensíticos ≤ 850 N/mm ² 1.4112 X90CrMoV18 1.4540 X4CrNiCuNb16-4 1.4582 X4CrNiMoNb25-7 1.4762 X10CrAl24 1.4922 X20CrMo11-1	24 Ferríticos y martensíticos > 850 - ≤ 1150 N/mm ² 1.4057 X17CrNi17-2 1.4125 X105CrMo17 1.4542 X5CrNiCuNb16-4 1.4548 X5CrNiCuNb17-4-4 1.4748 X85CrMoV18-2	31 Fundición gris 0.6015 GG15 0.6020 GG20 0.6025 GG25 0.6030 GG30	32 Fundición de grafito + esferoidal y maleable 0.7040 GGG40 0.7043 GGG40.3 0.7050 GGG50 0.7060 GGG60 0.7080 GGG80	41 Titanio puro 3.7024 Grad1 3.7034 Grad2 3.7055 Grad3 3.7065 Grad4
42 Aleación al titanio 3.7124 TiCu2.5 TiAl7Nb 3.7164 TiAl6V4 (Grad5) 3.7174 TiAl6V6Sn2	51 Aleación al Niquel 1 ≤ 850 N/mm ² 1.3912 Ni36 (Invar) 2.4360 NiCu30Fe (Monel 400) 2.4816 NiCr15Fe (Inconel 600) 1.4876 X10NiCrAlTi32-20	52 Aleación al Niquel 2 > 850 - ≤ 1150 N/mm ² 2.4375 NiCu30Al (MonelK500) 2.4631 NiCr20TiAl (Nimonic 80) 2.4668 NiCr19NbMo (Inconel718)	53 Aleación al Niquel 3 > 1150 - ≤ 1600 N/mm ² 2.4631 NiCr20TiAl (Nimonic80) 2.4668 NiCr19NbMo (Inconel718)	61 Cobre puro (electrolítico) 2.0060 E-Cu57 (E-Cu)
62 Latón, bronce (virutas cortas) 2.0401 CuZn39Pb3 (Ms58) 2.0402 CuZn40Pb2 (Ms58) 2.1030 CuSn8 (Bz) 2.1096 G-CuSn5ZnPb	63 Latón (virutas largas) 2.0240 CuZn15 (Ms85) 2.0265 CuZn30 (Ms70) 2.0321 CuZn37 (Ms63)	71 Al no aleado 3.0205 Al99 3.0255 Al99.5	72 Al aleado Si ≤ 1.5 % 3.1255 AlCuSiMn 3.1355 AlCuMg2 3.2315 AlMgSi1 3.3206 AlMgSi0.5 3.4345 AlZnMgCu0.5	73 Al aleado Si > 1.5 % - ≤ 10 % 3.2161 G-AlSi8Cu3 3.2162 GD-AlSi8Cu3 3.2341 G-AlSi5Mg 3.2371 G-AlSi7Mg
74 Al aleado Si > 10 %, Aleaciones Magnesio 3.2381 G-AlSi10Mg 3.2382 GD-AlSi10Mg 3.2581 G-AlSi12 3.2583 G-AlSi12 (Cu)	81 Materiales termoplásticos Delrin (POM) Teflon Nylon	82 Materiales duroplásticos Bakelit Novopan	83 Materiales plásticos reforzados por fibras Materiales plásticos reforzados por fibras	Referencia: DIN
91 Oro amarillo 2N18 Au585AgCu205 3N18 Au917AgCu44	92 Oro rojo 4N18 5N18 Au585CuAg325 Au750AgCu Au917Cu83	93 Oro blanco Au750PdCu125 Au750PdCu150 Au585PdCu150 Au925Pd75	94 Plata Ag999 Ag800Cu Ag925Cu	

APPLICATION GROUPS

Examples for application groups

11 Free-cutting steels 1.0711 1212 1.0715 1213 1.0718 12L13 1.0726 1140 1.0737 12L14	12 Structural, cementation steels 1.0037 1015 1.0050 A570 Gr.50 1.0060 A572 Gr.65 1.5919 3115 1.7131 5115	13 Carbon steels 1.0503 1045 1.0535 1055 1.0601 1060 1.1545 W110 1.2067 L 3	14 Alloy steels < 850 N/mm ² 1.2363 A2 1.3551 M50 1.7218 4130 1.7220 4135 1.7225 4140	15 Alloy steels hard./temp. > 850 - < 1150 N/mm ² 1.3553 - 1.6580 4340 1.7220 4135 1.7225 4140 1.8507 A355CLD (K23510)
16 High tensile alloy steels ≤ 44 HRC EN-GJS-1200-2 1.6582 4340 1.7225 4140 1.7228 4150 1.8515 -	17 Alloy steels tempered > 44 - ≤ 54 HRC > 44 - ≤ 54 HRC	18 Alloy steels hardened > 54 - ≤ 63 HRC > 54 - ≤ 63 HRC	21 Free machining stainless steels 1.4005 416 1.4104 430F 1.4305 303	22 Austenitic stainless steels 1.4301 304 1.4406 316LN 1.4435 316L 1.4541 321 1.4571 316Ti
23 Ferritic and martensitic < 850 N/mm ² 1.4112 440B 1.4540 XM12 (15-5PH) 1.4582 - 1.4762 446 1.4821 4922	24 Ferritic and martensitic > 850 - < 1150 N/mm ² 1.4057 431 1.4125 440C 1.4542 630 (17-4PH) 1.4748 -	31 Cast iron 0.6015 A48-25B 0.6020 A48-30B 0.6025 A48-40B 0.6030 A48-45B	32 Spheroidal graphite + malleable cast iron 0.7040 60-40-18 0.7043 - 0.7050 65-45-12 0.7060 80-55-06 0.7080 120-90-02	41 Pure titanium 3.7024 Gr.1 3.7034 Gr.2 3.7055 Gr.3 3.7065 Gr.4
42 Titanium alloys 3.7124 Alloy 230 F-1295 3.7164 Gr.5 3.7174 -	51 Nickel alloys 1 ≤ 850 N/mm ² 1.3912 K93600 2.4360 N04400 1.4816 N08800	52 Nickel alloys 2 > 850 - ≤ 1150 N/mm ² 2.4375 N05500 (B865) 2.4631 N07080 (B637) 2.4668 N07718 (B637)	53 Nickel alloys 3 > 1150 - ≤ 1600 N/mm ² 2.4631 N07080 (B637) 2.4668 N07718 (B637)	61 Pure copper (electrolytic copper) 2.0060 C11000
62 Short chip brass, phosphor bronze, gun metal 2.0401 C38500 2.0402 C37800 2.1030 C52100 2.1096 -	63 Long chip brass 2.0240 C23000 2.0265 C26000 2.0321 C27200	71 Al unalloyed 3.0205 1200 3.0255 1050A	72 Al alloyed Si < 1.5 % 3.1255 2014 3.1355 2024 3.2315 6082 3.3206 6060 3.4345 7020	73 Al alloyed Si > 1.5 % - < 10 % 3.2161 380.1 3.2162 - 3.2341 - 3.2371 A 356.2
74 Al alloyed Si > 10 %, Mg-alloys 3.2381 A360 3.2382 - 3.2581 A413 3.2583 413.1	81 Thermoplastics Delrin (POM) Teflon Nylon	82 Duroplastics Bakelit Novopan	83 Glass fibre reinforced plastics Glass fibre reinforced, Thermo and Duroplastics	Reference: AISI/ASTM/UNS
91 Yellow gold 2N18 Au585AgCu205 3N18 Au917AgCu44	92 Red gold 4N18 5N18 Au585CuAg325 Au750AgCu Au917Cu83	93 White gold Au750PdCu125 Au750PdCu150 Au585PdCu150 Au925Pd75	94 Silver Ag999 Ag800Cu Ag925Cu	

ESPECIFICACIONES — SPECIFICATIONS

RECUBRIMIENTO VS — VS-COATING

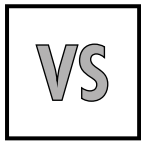

- Protección contra el desgaste "VS" para uso general
- Para evitar las soldaduras frías
*** **
- DC "VS" wear-protective coating for general use
- To prevent cold welding

NUEVO: RECUBRIMIENTO VX — NEW: VX-COATING



- Resistencia al desgaste mejorada en los aceros inoxidable y aleaciones de Ni gracias al recubrimiento "VX", duración de vida claramente prolongada
- Para evitar las soldaduras frías
*** **
- Improved wear resistance and longer tool life in stainless steels and Nickel alloys thanks to the DC "VX"-coating
- To prevent cold welding

NUEVO: RECUBRIMIENTO VH — NEW: VH-COATING



- Recubrimiento anti-desgaste "VH" para el trabajo en seco de aceros templados de 55 - 63 HRC
- Contra el aumento de calor y la deformación plástica
*** **
- DC "VH" wear-protective coating for dry machining of tempered steels with a hardness of 55 - 63 HRC
- Against heat development and plastic deformation

Fresa torbellino GW SERIES 1000 — Thread whirl cutter GW SERIES 1000



- Aplicación general
- Seguridad de proceso elevado
- Apto para dimensiones pequeñas
- Mas espacio para evacuar virutas
*** **
- Para profundidad de utilización hasta $2.5 \times D_1$
- Universal application
- High process security
- Suitable for the smallest dimensions
- More space for chip evacuation
- For threading depths up to $2.5 \times D_1$

Fresa torbellino GW SERIES 2000 — Thread whirl cutter GW SERIES 2000



- Velocidad de avance multiplicada según el numero de dientes
- Menos desgaste, vida útil aumentada
- Numeros de dientes varía según la dimensión
- Para profundidad de utilización hasta $2.5 \times D_1$
*** **
- Feed rate multiplied by number of teeth
- Less wear, longer tool life
- The number of teeth varies, depending on the size
- For threading depths up to $2.5 \times D_1$

Fresa torbellino GW SERIES 3000 — Thread whirl cutter GW SERIES 3000



- Seguridad del proceso, menos correcciones CN
*** **
- Para profundidad de utilización hasta $4 \times D_1$
- Secure process, reduction in NC-corrections
- For threading depths up to $4 \times D_1$

Fresa torbellino **GWi SERIES 3000** — Thread whirl cutter **GWi SERIES 3000**



- Gracias a la óptima alimentación del lubricante:
 - la evacuación de virutas es óptima
 - dobla la duración de vida
- Para profundidad de utilización hasta $4 \times D_1$
*** **
- Thanks to an optimal, specific coolant supply:
 - improved chip evacuation
 - twice the tool life
- For threading depths up to $4 \times D_1$

Fresa torbellino **GWi SERIES 5000** — Thread whirl cutter **GWi SERIES 5000**

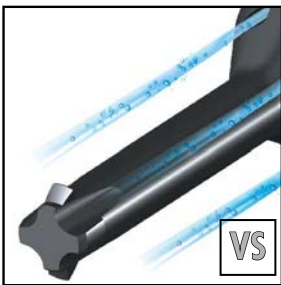

- Su geometría específica permite el fresado final del diámetro interior así que el desbarbado del perfil realizado
- Roscado geoméricamente perfecto gracias a un dispositivo de corte especial
- Para roscados sin rebabas, en todas clases de materiales y asegurando la precisión dimensional (tolerancia)
- Alta calidad de superficie gracias al condicionamiento de las aristas de corte
- Óptima evacuación de virutas y larga duración de vida gracia a la óptima alimentación del lubricante
- Seguridad de proceso, menos correcciones CN
- LH-Rot - Corte a izquierda, trabajando en concordancia, con menos presión sobre las aristas de corte
- Para profundidad de utilización hasta $3 \times D_1$
*** **
- Its specific geometry allows the final milling of the internal diameter and also the deburring of the realised profile
- Geometrically perfect thread thanks to special cutting division
- For absolutely burr-free threads, even in difficult-to-machine materials, while maintaining dimensional accuracy (tolerance)
- High surface quality thanks to specific cutting edge conditioning
- Improved chip evacuation and long tool life thanks to optimum coolant supply
- Secure process, reduction in NC-corrections
- LH rotation - left-hand cutting for less pressure on the cutting edges
- For threading depths up to $3 \times D_1$

Fresa torbellino **GWH SERIES 3000** — Thread whirl cutter **GWH SERIES 3000**



- Geometría especialmente adaptada para una resistencia en el corte de aceros templados hasta 63HRC
- Alta calidad de superficie gracias al condicionamiento de las aristas de corte
- LH-Rot - Corte a izquierda, trabajando en concordancia, con menos presión sobre las aristas de corte
- Para profundidad de utilización hasta $3 \times D_1$
*** **
- Special cutting geometry for high process security when machining high-tensile materials up to 63 HRC
- High surface quality thanks to specific cutting edge conditioning
- LH rotation - left-hand cutting for less pressure on the cutting edges
- For threading depths up to $3 \times D_1$

Taladro y roscado circular **ZBGF SERIES 6000** — Circular drill thread milling cutter **ZBGF SERIES 6000**

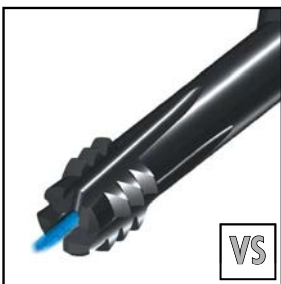

- Herramienta combinada para fresar el diámetro previo asin que el roscado
- Lubricación interna para una óptima evacuación de virutas (min. 20 bares)
- Alta calidad de superficie gracias al condicionamiento de las aristas de corte
- LH-Rot - Corte a izquierda, trabajando en concordancia, con menos presión sobre las aristas de corte
- Para profundidad de utilización hasta $3 \times D_1$
*** **
- Combinated tool for drilling the core hole and whirling the thread
- Advanced internal cooling for optimum chip removal (at least 20 bar)
- High surface quality thanks to specific cutting edge conditioning
- LH rotation - left-hand cutting for less pressure on the cutting edges
- For threading depths up to $3 \times D_1$

APLICACIONES CONCRETAS — SPECIFIC APPLICATION CASES

GW - GWH - GWi - GF - GFH - GFS - GFM

RH

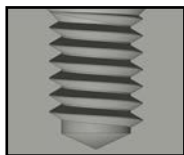

LH

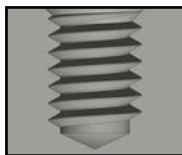

Una única fresa para roscas derechas y izquierdas
The same thread whirler / cutter can be used for right- and left-hand threads

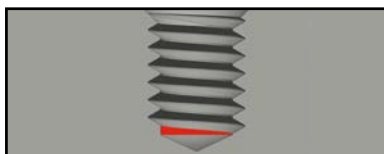

Fresado a fondo de hilo
For threads to be cut near to the bottom of blind holes

M8 6H

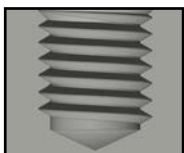

M8 7G

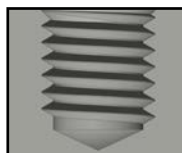

Tolerancia requerida ajustable
Required tolerance adjustable as per users choice

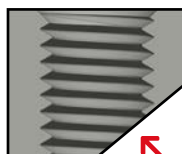
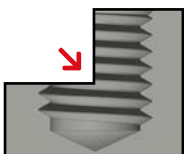

Posibilidad de roscar partes oblicuas o interrumpidas
For threads with interrupted cut or with oblique entrance or exit

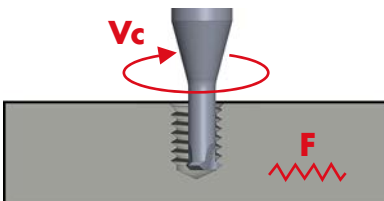

Velocidad de corte y avance gestionada individualmente en función del material a roscar
The cutting speed and feed rate can be matched individually to each work-piece material

GW - GWi

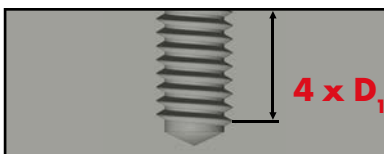

Óptimo para agujeros ciegos profundos
Ideal for deep blind holes

GWH - GFH



Para roscar aceros templados
To realise threads in hardened materials

GWi5000

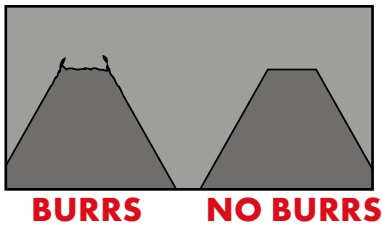

Para roscar sin dejar rebabas
For whirling burr-free threads

ZBGF

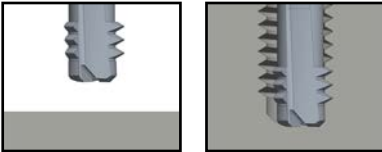

Herramienta combinada para el corte del previo y el fresado del roscado
Combinated tool for drilling and threading

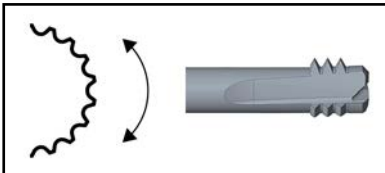

Ganar espacio en el almacén CN y economía del tiempo de intercambio herramienta
Space-saving in the tool carousel; time saving when tool changing

GFS

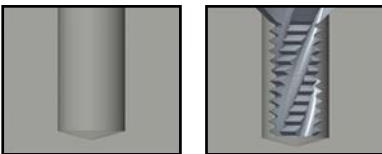

Achaflanar 45° y roscar con una sola herramienta
45° countersinking and thread milling with one only tool

GFM

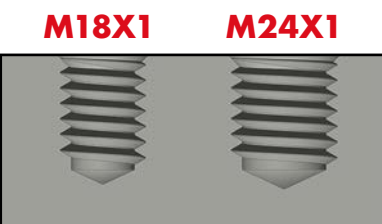

Posibilidad de trabajar una multitud de diámetros a paso idéntico
One only tool for threads of a wide range of diameters with the same pitch

BGF

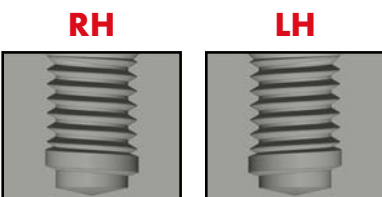

Una única fresa de taladrar/roscar para rosca derecha y izquierda
The same thriller can be used for right- and left-hand threads

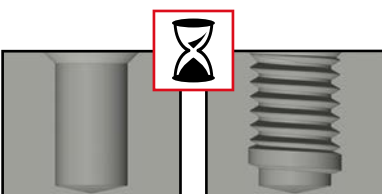

Ganancia de tiempo y de sitio en el almacén de la máquina
Space-saving in the tool carousel and saving of machining time

TABLA DE UTILIZACIÓN GW— APPLICATION CHART GW

Ciclo de programación para fresas torbellino GW1000 y GW2000
 Programming cycle for thread whirling GW1000 and GW2000

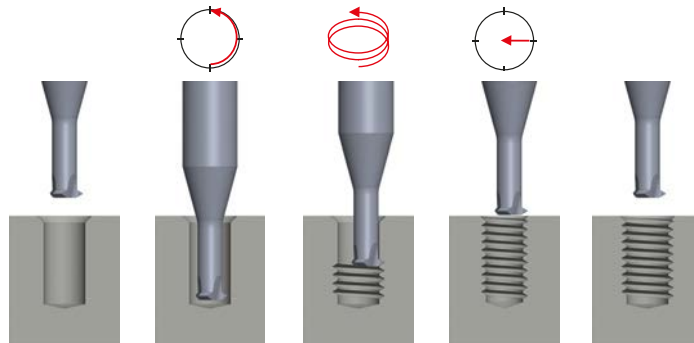

DC Tabla de utilización para fresas torbellino **DC** Application chart for thread whirling

Grupos de materiales Material groups	Clasificación de los materiales	Material designation	Dureza Hardness (HB)	Resistencia Tensile strength Rm (N/mm ²)	Lubricante Lubricant	
					Estándar Standard	Recub. Coated
10 Aceros Steels	11 Aceros de decoletaje	Free-cutting steels	< 200	< 700		OE
	12 Aceros de construcción o de cementación	Structural, cementation steels	< 200	< 700		OE
	13 Aceros al carbón	Carbon steels	< 300	< 1000		OE
	14 Aceros aleados < 850 N/mm ²	Alloy steels < 850 N/mm ²	< 250	< 850		OE
	15 Aceros aleados/trat. > 850 - < 1150 N/mm ²	Alloy steels hard./ temp. > 850 - < 1150 N/mm ²	> 250	> 850		OE
	16 Aceros de alta resistencia ≤ 44 HRC	High tensile alloy steels ≤ 44 HRC	> 250	> 850		OE
	17 Aceros templados y revenidos > 44 - ≤ 54 HRC	Alloy steels tempered > 44 - ≤ 54 HRC	> 410	> 1400		OE
	18 Aceros templados > 54 - ≤ 63 HRC	Alloy steels hardened > 54 - ≤ 63 HRC	> 560	> 1980		
20 Aceros inoxidables Stainless steels	21 Aceros inoxidables al azufre	Free machining stainless steels	< 250	< 850		OE
	22 Austeníticos	Austenitic stainless steels	< 250	< 850		OE
	23 Ferríticos y martensíticos < 850 N/mm ²	Ferritic and martensitic < 850 N/mm ²	< 250	< 850		OE
	24 Ferríticos y martensíticos > 850 - < 1150 N/mm ²	Ferritic and martensitic > 850 - < 1150 N/mm ²	> 250	> 850		OE
30 Fundición Cast iron	31 Fundición gris	Cast iron	< 250	< 850		OE A
	32 Fundición de grafito + esferoidal y maleable	Spheroidal graphite + malleable cast iron	< 250	< 850		OE
40 Titanio Titanium	41 Titanio puro	Pure titanium	< 250	< 850	OE	OE
	42 Aleación al titanio	Titanium alloys	> 250	> 850	OE	OE
50 Níquel Nickel	51 Aleación al Níquel 1 ≤ 850 N/mm ²	Nickel alloys 1 ≤ 850 N/mm ²	< 250	< 850		OE
	52 Aleación al Níquel 2 > 850 - ≤ 1150 N/mm ²	Nickel alloys 2 > 850 - ≤ 1150 N/mm ²	> 250	> 850		OE
	53 Aleación al Níquel 3 > 1150 - ≤ 1600 N/mm ²	Nickel alloys 3 > 1150 - ≤ 1600 N/mm ²	> 340	> 1150		OE
60 Cobre Copper	61 Cobre puro (electrolítico)	Pure copper (electrolytic copper)	< 120	< 400	OE	OE
	62 Latón, bronce (virutas cortas)	Short chip brass, phosphor bronze, gun metal	< 200	< 700	OE A	OE A
	63 Latón (virutas largas)	Long chip brass	< 200	< 700	OE	OE
70 Aluminio Magnesio Aluminium Magnesium	71 Al no aleado	Al unalloyed	< 100	< 350	OE	OE
	72 Al aleado Si < 1.5 %	Al alloyed Si < 1.5 %	< 150	< 500	OE	OE
	73 Al aleado Si > 1.5 % - < 10 %	Al alloyed Si > 1.5 % - < 10 %	< 120	< 400		OE
	74 Al aleado Si > 10 %, Aleaciones Magnesio	Al alloyed Si > 10 %, Mg-alloys	< 120	< 400		OE
80 Materiales plásticos Plastic compounds	81 Materiales termoplásticos	Thermoplastics	-	-	E	E
	82 Materiales duroplásticos	Duroplastics	-	-	E	E
	83 Materiales plásticos reforzados por fibras	Glass fibre reinforced plastics	-	-		E A
90 Metales preciosos Precious metals	91 Oro amarillo	Yellow gold	-	-	OE	OE
	92 Oro rojo	Red gold	-	-	OE	OE
	93 Oro blanco	White gold	-	-		OE
	94 Plata	Silver	-	-		OE

O Óptimo con aceite de corte
Optimal with cutting oil

O Aceptable con aceite de corte
Suitable with cutting oil

E Óptimo con emulsión
Optimal with emulsion

E Aceptable con emulsión
Suitable with emulsion

GW1116



VS

Vc (m/min)		Avance fz (mm/diente)	Milling fz (mm/tooth)
Estándar Standard	Recub. Coated		
	80-100		0.004-0.02
	80-100		0.004-0.02
	70-90		0.004-0.02
	70-90		0.004-0.02
	30-50		0.004-0.02
	15-40		0.004-0.02
	15-30		0.004-0.02
	40-60		0.004-0.02
	30-50		0.004-0.02
	30-50		0.004-0.02
	30-50		0.004-0.02
	90-120		0.004-0.02
	70-90		0.004-0.02
10-20	20-40	0.004-0.02	0.004-0.02
10-20	15-35	0.004-0.02	0.004-0.02
	20-40		0.004-0.02
	20-40		0.004-0.02
	20-30		0.004-0.02
150-200	200-250	0.004-0.02	0.004-0.02
100-150	150-200	0.004-0.02	0.004-0.02
100-150	150-200	0.004-0.02	0.004-0.02
150-200	200-250	0.004-0.02	0.004-0.02
150-200	200-250	0.004-0.02	0.004-0.02
	200-250		0.004-0.02
	200-250		0.004-0.02
150-200	200-250	0.004-0.02	0.004-0.02
80-120	100-200	0.004-0.02	0.004-0.02
	80-100		0.004-0.02
100-150	150-200	0.004-0.02	0.004-0.02
	70-90		0.004-0.02
	30-50		0.004-0.02
	90-120		0.004-0.02

GW2016



VS

VS

VS

VS

Vc (m/min)		Avance fz (mm/diente)				Milling fz (mm/tooth)				
Estándar Standard	Recub. Coated	Ø 0.50 - 1.00		Ø 1.01 - 2.74		Ø 2.75 - 6.00		Ø 6.01 - 20.00		
	80-100		0.004-0.01		0.01-0.05		0.04-0.10		0.08-0.15	11
	80-100		0.004-0.01		0.01-0.05		0.04-0.10		0.08-0.15	12
	70-90		0.004-0.01		0.01-0.05		0.02-0.10		0.05-0.15	13
	70-90		0.004-0.01		0.01-0.05		0.02-0.10		0.05-0.15	14
	30-50		0.004-0.01		0.01-0.05		0.02-0.08		0.04-0.15	15
	15-40		0.003-0.01		0.006-0.03		0.008-0.05		0.01-0.08	16
	15-30		0.003-0.01		0.006-0.025		0.008-0.04		0.01-0.06	17
										18
	40-60		0.004-0.01		0.01-0.05		0.02-0.10		0.05-0.15	21
	30-50		0.004-0.01		0.01-0.03		0.02-0.05		0.03-0.08	22
	30-50		0.004-0.01		0.01-0.03		0.02-0.05		0.03-0.08	23
	30-50		0.004-0.01		0.01-0.03		0.02-0.05		0.03-0.08	24
	90-120		0.004-0.01		0.01-0.05		0.04-0.10		0.08-0.15	31
	70-90		0.004-0.01		0.01-0.05		0.02-0.10		0.05-0.15	32
10-20	20-40	0.004-0.01	0.004-0.01	0.01-0.03	0.01-0.03	0.02-0.05	0.02-0.05	0.03-0.08	0.03-0.08	41
10-20	15-35	0.004-0.01	0.004-0.01	0.01-0.03	0.01-0.03	0.02-0.05	0.02-0.05	0.03-0.08	0.03-0.08	42
	20-40		0.004-0.01		0.01-0.03		0.02-0.06		0.03-0.08	51
	20-40		0.004-0.01		0.01-0.03		0.02-0.06		0.03-0.08	52
	20-30		0.003-0.01		0.006-0.03		0.008-0.05		0.03-0.08	53
150-200	200-250	0.004-0.01	0.004-0.01	0.01-0.05	0.01-0.05	0.02-0.10	0.02-0.10	0.05-0.15	0.05-0.15	61
100-150	150-200	0.004-0.01	0.004-0.01	0.01-0.05	0.01-0.05	0.04-0.10	0.04-0.10	0.08-0.15	0.08-0.15	62
100-150	150-200	0.004-0.01	0.004-0.01	0.01-0.05	0.01-0.05	0.02-0.10	0.02-0.10	0.05-0.15	0.05-0.15	63
150-200	200-300	0.004-0.01	0.004-0.01	0.01-0.05	0.01-0.05	0.05-0.10	0.05-0.10	0.10-0.20	0.10-0.20	71
150-200	200-300	0.004-0.01	0.004-0.01	0.01-0.05	0.01-0.05	0.05-0.10	0.05-0.10	0.10-0.20	0.10-0.20	72
	200-300		0.004-0.01		0.01-0.05		0.05-0.10		0.10-0.20	73
	200-300		0.004-0.01		0.01-0.05		0.04-0.10		0.08-0.15	74
150-200	200-300	0.004-0.01	0.004-0.01	0.01-0.05	0.01-0.05	0.05-0.10	0.05-0.10	0.10-0.20	0.10-0.20	81
80-120	100-200	0.004-0.01	0.004-0.01	0.01-0.05	0.01-0.05	0.04-0.10	0.04-0.10	0.08-0.15	0.08-0.15	82
	80-100		0.004-0.01		0.01-0.05		0.04-0.10		0.08-0.15	83
100-150	150-200	0.004-0.01	0.004-0.01	0.01-0.05	0.01-0.05	0.04-0.10	0.04-0.10	0.08-0.15	0.08-0.15	91
	70-90		0.004-0.01		0.01-0.05	0.02-0.10	0.02-0.10	0.04-0.15	0.04-0.15	92
	30-50		0.004-0.01		0.01-0.05		0.02-0.05		0.03-0.08	93
	90-120		0.004-0.01		0.01-0.05		0.02-0.10		0.04-0.15	94

A Óptimo con aire
Optimal with air

A Aceptable con aire
Suitable with air

Los valores son indicativos.
The indicated values are a guideline.

TABLA DE UTILIZACIÓN GW - GWi — APPLICATION CHART GW - GWi

Ciclo de programación para fresas torbellino GW3000 - GWi3000
 Programming cycle for thread whirling GW3000 - GWi3000

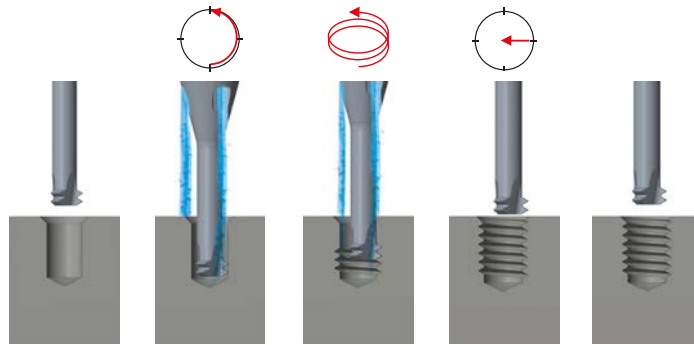

DC Tabla de utilización para fresas torbellino DC Application chart for thread whirling

Grupos de materiales Material groups	Clasificación de los materiales	Material designation	Dureza Hardness (HB)	Resistencia Tensile strength Rm (N/mm ²)	Lubricante Lubricant	
					Estándar Standard	Recub. Coated
10 Aceros Steels	11 Aceros de decoletaje	Free-cutting steels	< 200	< 700		OE
	12 Aceros de construcción o de cementación	Structural, cementation steels	< 200	< 700		OE
	13 Aceros al carbón	Carbon steels	< 300	< 1000		OE
	14 Aceros aleados < 850 N/mm ²	Alloy steels < 850 N/mm ²	< 250	< 850		OE
	15 Aceros aleados/trat. > 850 - < 1150 N/mm ²	Alloy steels hard./ temp. > 850 - < 1150 N/mm ²	> 250	> 850		OE
	16 Aceros de alta resistencia ≤ 44 HRC	High tensile alloy steels ≤ 44 HRC	> 250	> 850		OE
	17 Aceros templados y revenidos > 44 - ≤ 54 HRC	Alloy steels tempered > 44 - ≤ 54 HRC	> 410	> 1400		OE
	18 Aceros templados > 54 - ≤ 63 HRC	Alloy steels hardened > 54 - ≤ 63 HRC	> 560	> 1980		
20 Aceros inoxidables Stainless steels	21 Aceros inoxidables al azufre	Free machining stainless steels	< 250	< 850		OE
	22 Austeníticos	Austenitic stainless steels	< 250	< 850		OE
	23 Ferríticos y martensíticos < 850 N/mm ²	Ferritic and martensitic < 850 N/mm ²	< 250	< 850		OE
	24 Ferríticos y martensíticos > 850 - < 1150 N/mm ²	Ferritic and martensitic > 850 - < 1150 N/mm ²	> 250	> 850		OE
30 Fundición Cast iron	31 Fundición gris	Cast iron	< 250	< 850		OE A
	32 Fundición de grafito + esferoidal y maleable	Spheroidal graphite + malleable cast iron	< 250	< 850		OE
40 Titanio Titanium	41 Titanio puro	Pure titanium	< 250	< 850	OE	OE
	42 Aleación al titanio	Titanium alloys	> 250	> 850	OE	OE
50 Níquel Nickel	51 Aleación al Níquel 1 ≤ 850 N/mm ²	Nickel alloys 1 ≤ 850 N/mm ²	< 250	< 850		OE
	52 Aleación al Níquel 2 > 850 - ≤ 1150 N/mm ²	Nickel alloys 2 > 850 - ≤ 1150 N/mm ²	> 250	> 850		OE
	53 Aleación al Níquel 3 > 1150 - ≤ 1600 N/mm ²	Nickel alloys 3 > 1150 - ≤ 1600 N/mm ²	> 340	> 1150		OE
60 Cobre Copper	61 Cobre puro (electrolítico)	Pure copper (electrolytic copper)	< 120	< 400	OE	OE
	62 Latón, bronce (virutas cortas)	Short chip brass, phosphor bronze, gun metal	< 200	< 700	OE A	OE A
	63 Latón (virutas largas)	Long chip brass	< 200	< 700	OE	OE
70 Aluminio Magnesio Aluminium Magnesium	71 Al no aleado	Al unalloyed	< 100	< 350	OE	OE
	72 Al aleado Si < 1.5 %	Al alloyed Si < 1.5 %	< 150	< 500	OE	OE
	73 Al aleado Si > 1.5 % - < 10 %	Al alloyed Si > 1.5 % - < 10 %	< 120	< 400		OE
	74 Al aleado Si > 10 %, Aleaciones Magnesio	Al alloyed Si > 10 %, Mg-alloys	< 120	< 400		OE
80 Materiales plásticos Plastic compounds	81 Materiales termoplásticos	Thermoplastics	-	-	E	E
	82 Materiales duroplásticos	Duroplastics	-	-	E	E
	83 Materiales plásticos reforzados por fibras	Glass fibre reinforced plastics	-	-		E A
90 Metales preciosos Precious metals	91 Oro amarillo	Yellow gold	-	-	OE	OE
	92 Oro rojo	Red gold	-	-	OE	OE
	93 Oro blanco	White gold	-	-		OE
	94 Plata	Silver	-	-		OE

Óptimo con aceite de corte
Optimal with cutting oil

Aceptable con aceite de corte
Suitable with cutting oil

Óptimo con emulsión
Optimal with emulsion

Aceptable con emulsión
Suitable with emulsion

GW3000 - GWi3000

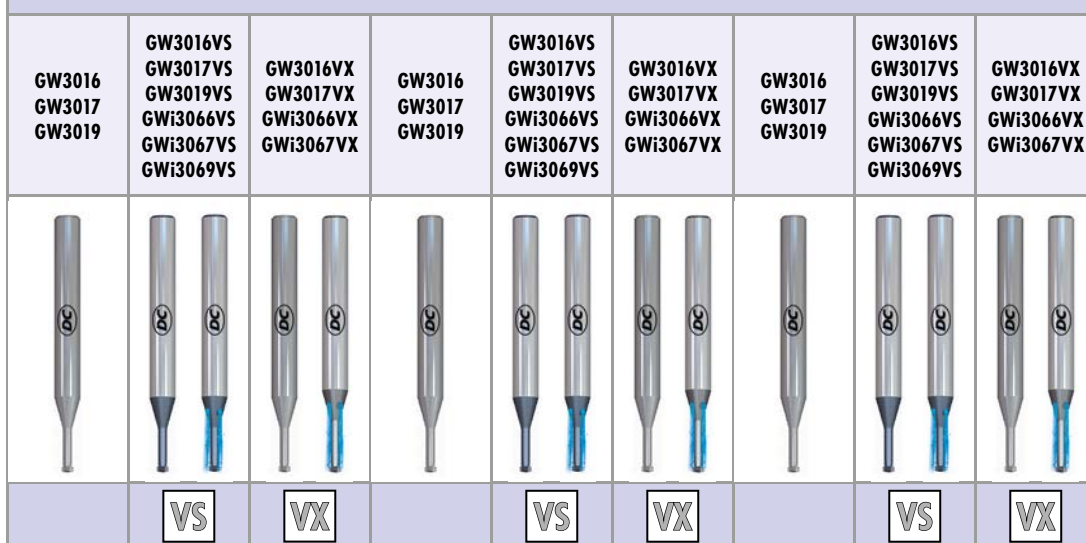

Vc (m/min)		Avance fz (mm/diente)									Milling fz (mm/tooth)									
		Ø 0.80 - 2.74			Ø 2.75 - 6.00			Ø 6.01 - 20.00			Ø 0.80 - 2.74			Ø 2.75 - 6.00			Ø 6.01 - 20.00			
		Estándar Standard	Recub. Coated																	
	80-100			0.01-0.05	0.01-0.05				0.04-0.10	0.04-0.10				0.08-0.15	0.08-0.15				11	
	80-100			0.01-0.05	0.01-0.05				0.04-0.10	0.04-0.10				0.08-0.15	0.08-0.15				12	
	70-90			0.01-0.05	0.01-0.05				0.02-0.10	0.02-0.10				0.05-0.15	0.05-0.15				13	
	70-90			0.01-0.05	0.01-0.05				0.02-0.10	0.02-0.10				0.05-0.15	0.05-0.15				14	
	30-50			0.01-0.05	0.01-0.05				0.02-0.08	0.02-0.08				0.04-0.15	0.04-0.15				15	
	15-40			0.006-0.03	0.006-0.03				0.008-0.05	0.008-0.05				0.01-0.08	0.01-0.08				16	
	15-30			0.006-0.025	0.006-0.025				0.008-0.04	0.008-0.04				0.01-0.06	0.01-0.06				17	
																			18	
	40-60			0.01-0.05	0.01-0.05				0.02-0.10	0.02-0.10				0.05-0.15	0.05-0.15				21	
	30-50			0.01-0.03	0.01-0.03				0.02-0.05	0.02-0.05				0.03-0.08	0.03-0.08				22	
	30-50			0.01-0.03	0.01-0.03				0.02-0.05	0.02-0.05				0.03-0.08	0.03-0.08				23	
	30-50			0.01-0.03	0.01-0.03				0.02-0.05	0.02-0.05				0.03-0.08	0.03-0.08				24	
	90-120			0.01-0.05	0.01-0.05				0.04-0.10	0.04-0.10				0.08-0.15	0.08-0.15				31	
	70-90			0.01-0.05	0.01-0.05				0.02-0.10	0.02-0.10				0.05-0.15	0.05-0.15				32	
10-20	20-40			0.01-0.03	0.01-0.03	0.01-0.03	0.02-0.05	0.02-0.05	0.02-0.05	0.02-0.05	0.03-0.08	0.03-0.08	0.03-0.08	0.03-0.08	0.03-0.08				41	
10-20	15-35			0.01-0.03	0.01-0.03	0.01-0.03	0.02-0.05	0.02-0.05	0.02-0.05	0.02-0.05	0.03-0.08	0.03-0.08	0.03-0.08	0.03-0.08	0.03-0.08				42	
	20-40			0.01-0.03	0.01-0.03				0.02-0.06	0.02-0.06				0.03-0.08	0.03-0.08				51	
	20-40			0.01-0.03	0.01-0.03				0.02-0.06	0.02-0.06				0.03-0.08	0.03-0.08				52	
	20-30			0.006-0.03	0.006-0.03				0.008-0.05	0.008-0.05				0.03-0.08	0.03-0.08				53	
150-200	200-250			0.01-0.05	0.01-0.05	0.01-0.05	0.02-0.10	0.02-0.10	0.02-0.10	0.02-0.10	0.05-0.15	0.05-0.15	0.05-0.15	0.05-0.15	0.05-0.15				61	
100-150	150-200			0.01-0.05	0.01-0.05	0.01-0.05	0.04-0.10	0.04-0.10	0.04-0.10	0.04-0.10	0.08-0.15	0.08-0.15	0.08-0.15	0.08-0.15	0.08-0.15				62	
100-150	150-200			0.01-0.05	0.01-0.05	0.01-0.05	0.02-0.10	0.02-0.10	0.02-0.10	0.02-0.10	0.05-0.15	0.05-0.15	0.05-0.15	0.05-0.15	0.05-0.15				63	
150-200	200-300			0.01-0.05	0.01-0.05	0.01-0.05	0.05-0.10	0.05-0.10	0.05-0.10	0.05-0.10	0.10-0.20	0.10-0.20	0.10-0.20	0.10-0.20	0.10-0.20				71	
150-200	200-300			0.01-0.05	0.01-0.05	0.01-0.05	0.05-0.10	0.05-0.10	0.05-0.10	0.05-0.10	0.10-0.20	0.10-0.20	0.10-0.20	0.10-0.20	0.10-0.20				72	
	200-300			0.01-0.05	0.01-0.05				0.05-0.10	0.05-0.10				0.10-0.20	0.10-0.20				73	
	200-300			0.01-0.05	0.01-0.05				0.04-0.10	0.04-0.10				0.08-0.15	0.08-0.15				74	
150-200	200-300			0.01-0.05	0.01-0.05	0.01-0.05	0.05-0.10	0.05-0.10	0.05-0.10	0.05-0.10	0.10-0.20	0.10-0.20	0.10-0.20	0.10-0.20	0.10-0.20				81	
80-120	100-200			0.01-0.05	0.01-0.05	0.01-0.05	0.04-0.10	0.04-0.10	0.04-0.10	0.04-0.10	0.08-0.15	0.08-0.15	0.08-0.15	0.08-0.15	0.08-0.15				82	
	80-100			0.01-0.05	0.01-0.05				0.04-0.10	0.04-0.10				0.08-0.15	0.08-0.15				83	
100-150	150-200			0.01-0.05	0.01-0.05	0.01-0.05	0.04-0.10	0.04-0.10	0.04-0.10	0.04-0.10	0.08-0.15	0.08-0.15	0.08-0.15	0.08-0.15	0.08-0.15				91	
	70-90			0.01-0.05	0.01-0.05	0.01-0.05	0.02-0.10	0.02-0.10	0.02-0.10	0.02-0.10	0.04-0.15	0.04-0.15	0.04-0.15	0.04-0.15	0.04-0.15				92	
	30-50			0.01-0.05	0.01-0.05				0.02-0.05	0.02-0.05				0.03-0.08	0.03-0.08				93	
	90-120			0.01-0.05	0.01-0.05				0.02-0.10	0.02-0.10				0.04-0.15	0.04-0.15				94	

A Óptimo con aire
Optimal with air

A Aceptable con aire
Suitable with air

Los valores son indicativos.
The indicated values are a guideline.

TABLA DE UTILIZACIÓN GWi - GWH — APPLICATION CHART GWi - GWH

Ciclo de programación para fresas torbellino GWi5000 - GWH3000

Programming cycle for thread whirling GWi5000 - GWH3000

GWi5000

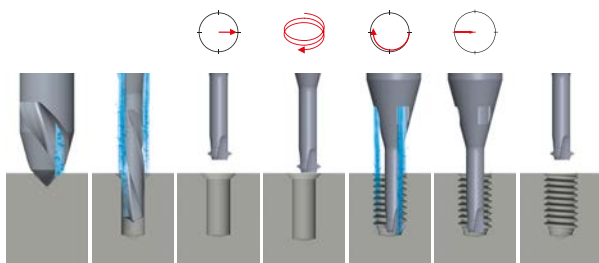

GWH3000

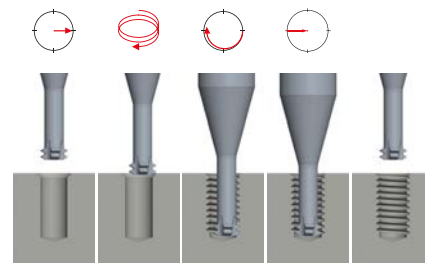

DC Tabla de utilización para fresas torbellino DC Application chart for thread whirling

Grupos de materiales Material groups	Clasificación de los materiales	Material designation	Dureza Hardness (HB)	Resistencia Tensile strength Rm (N/mm ²)	Lubricante Lubricant	
					Estándar Standard	Recub. Coated
10 Aceros Steels	11 Aceros de decoletaje	Free-cutting steels	< 200	< 700		OE
	12 Aceros de construcción o de cementación	Structural, cementation steels	< 200	< 700		OE
	13 Aceros al carbón	Carbon steels	< 300	< 1000		OE
	14 Aceros aleados < 850 N/mm ²	Alloy steels < 850 N/mm ²	< 250	< 850		OE
	15 Aceros aleados/trat. > 850 - < 1150 N/mm ²	Alloy steels hard./ temp. > 850 - < 1150 N/mm ²	> 250	> 850		OE
	16 Aceros de alta resistencia ≤ 44 HRC	High tensile alloy steels ≤ 44 HRC	> 250	> 850		OE
	17 Aceros templados y revenidos > 44 - ≤ 54 HRC	Alloy steels tempered > 44 - ≤ 54 HRC	> 410	> 1400		OE
	18 Aceros templados > 54 - ≤ 63 HRC	Alloy steels hardened > 54 - ≤ 63 HRC	> 560	> 1980		
20 Aceros inoxidables Stainless steels	21 Aceros inoxidables al azufre	Free machining stainless steels	< 250	< 850		OE
	22 Austeníticos	Austenitic stainless steels	< 250	< 850		OE
	23 Ferríticos y martensíticos < 850 N/mm ²	Ferritic and martensitic < 850 N/mm ²	< 250	< 850		OE
	24 Ferríticos y martensíticos > 850 - < 1150 N/mm ²	Ferritic and martensitic > 850 - < 1150 N/mm ²	> 250	> 850		OE
30 Fundición Cast iron	31 Fundición gris	Cast iron	< 250	< 850		OE
	32 Fundición de grafito + esferoidal y maleable	Spheroidal graphite + malleable cast iron	< 250	< 850		OE
40 Titanio Titanium	41 Titanio puro	Pure titanium	< 250	< 850		OE
	42 Aleación al titanio	Titanium alloys	> 250	> 850		OE
50 Níquel Nickel	51 Aleación al Níquel 1 ≤ 850 N/mm ²	Nickel alloys 1 ≤ 850 N/mm ²	< 250	< 850		OE
	52 Aleación al Níquel 2 > 850 - ≤ 1150 N/mm ²	Nickel alloys 2 > 850 - ≤ 1150 N/mm ²	> 250	> 850		OE
	53 Aleación al Níquel 3 > 1150 - ≤ 1600 N/mm ²	Nickel alloys 3 > 1150 - ≤ 1600 N/mm ²	> 340	> 1150		OE
60 Cobre Copper	61 Cobre puro (electrolítico)	Pure copper (electrolytic copper)	< 120	< 400		OE
	62 Latón, bronce (virutas cortas)	Short chip brass, phosphor bronze, gun metal	< 200	< 700		OE
	63 Latón (virutas largas)	Long chip brass	< 200	< 700		OE
70 Aluminio Magnesio Aluminium Magnesium	71 Al no aleado	Al unalloyed	< 100	< 350		OE
	72 Al aleado Si < 1.5 %	Al alloyed Si < 1.5 %	< 150	< 500		OE
	73 Al aleado Si > 1.5 % - < 10 %	Al alloyed Si > 1.5 % - < 10 %	< 120	< 400		OE
	74 Al aleado Si > 10 %, Aleaciones Magnesio	Al alloyed Si > 10 %, Mg-alloys	< 120	< 400		OE
80 Materiales plásticos Plastic compounds	81 Materiales termoplásticos	Thermoplastics	-	-		E
	82 Materiales duroplásticos	Duroplastics	-	-		E
	83 Materiales plásticos reforzados por fibras	Glass fibre reinforced plastics	-	-		E
90 Metales preciosos Precious metals	91 Oro amarillo	Yellow gold	-	-		OE
	92 Oro rojo	Red gold	-	-		OE
	93 Oro blanco	White gold	-	-		OE
	94 Plata	Silver	-	-		OE

Optimo con aceite de corte
Optimal with cutting oil

Aceptable con aceite de corte
Suitable with cutting oil

Optimo con emulsión
Optimal with emulsion

Aceptable con emulsión
Suitable with emulsion

TABLA DE UTILIZACIÓN ZBGF — APPLICATION CHART ZBGF

Ciclo de programación para fresas de taladro y roscado circular ZBGF6065 - ZBGF6067
 Programming cycle for circular drill thread milling cutters ZBGF6065 - ZBGF6067

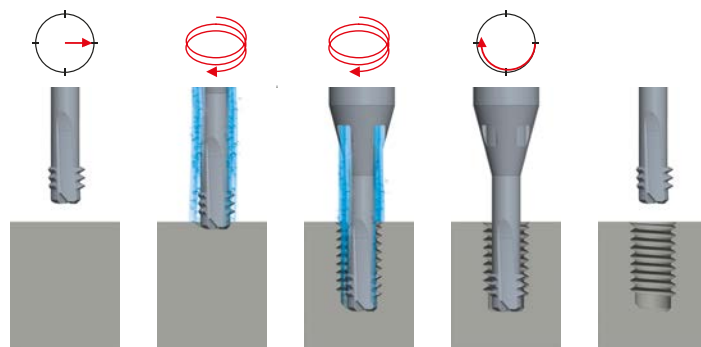

DC Tabla de utilización para fresas de taladro y roscado circular

DC Application chart for ZBGF

Grupos de materiales Material groups	Clasificación de los materiales	Material designation	Dureza Hardness (HB)	Resistencia Tensile strength Rm (N/mm ²)	Lubricante Lubricant		
					Estándar Standard	Recub. Coated	
10 Aceros Steels	11	Aceros de decoletaje	Free-cutting steels	< 200	< 700		OE
	12	Aceros de construcción o de cementación	Structural, cementation steels	< 200	< 700		OE
	13	Aceros al carbón	Carbon steels	< 300	< 1000		OE
	14	Aceros aleados < 850 N/mm ²	Alloy steels < 850 N/mm ²	< 250	< 850		OE
	15	Aceros aleados/trat. > 850 - < 1150 N/mm ²	Alloy steels hard./ temp. > 850 - < 1150 N/mm ²	> 250	> 850		OE
	16	Aceros de alta resistencia ≤ 44 HRC	High tensile alloy steels ≤ 44 HRC	> 250	> 850		OE
	17	Aceros templados y revenidos > 44 - ≤ 54 HRC	Alloy steels tempered > 44 - ≤ 54 HRC	> 410	> 1400		OE
	18	Aceros templados > 54 - ≤ 63 HRC	Alloy steels hardened > 54 - ≤ 63 HRC	> 560	> 1980		
20 Aceros inoxidables Stainless steels	21	Aceros inoxidables al azufre	Free machining stainless steels	< 250	< 850		OE
	22	Austeníticos	Austenitic stainless steels	< 250	< 850		OE
	23	Ferríticos y martensíticos < 850 N/mm ²	Ferritic and martensitic < 850 N/mm ²	< 250	< 850		OE
	24	Ferríticos y martensíticos > 850 - < 1150 N/mm ²	Ferritic and martensitic > 850 - < 1150 N/mm ²	> 250	> 850		OE
30 Fundición Cast iron	31	Fundición gris	Cast iron	< 250	< 850		OE
	32	Fundición de grafito + esferoidal y maleable	Spheroidal graphite + malleable cast iron	< 250	< 850		OE
40 Titanio Titanium	41	Titanio puro	Pure titanium	< 250	< 850		OE
	42	Aleación al titanio	Titanium alloys	> 250	> 850		OE
50 Níquel Nickel	51	Aleación al Níquel 1 ≤ 850 N/mm ²	Nickel alloys 1 ≤ 850 N/mm ²	< 250	< 850		OE
	52	Aleación al Níquel 2 > 850 - ≤ 1150 N/mm ²	Nickel alloys 2 > 850 - ≤ 1150 N/mm ²	> 250	> 850		OE
	53	Aleación al Níquel 3 > 1150 - ≤ 1600 N/mm ²	Nickel alloys 3 > 1150 - ≤ 1600 N/mm ²	> 340	> 1150		OE
60 Cobre Copper	61	Cobre puro (electrolítico)	Pure copper (electrolytic copper)	< 120	< 400		
	62	Latón, bronce (virutas cortas)	Short chip brass, phosphor bronze, gun metal	< 200	< 700		OE
	63	Latón (virutas largas)	Long chip brass	< 200	< 700		OE
70 Aluminio Magnesio Aluminium Magnesium	71	Al no aleado	Al unalloyed	< 100	< 350		OE
	72	Al aleado Si < 1.5 %	Al alloyed Si < 1.5 %	< 150	< 500		OE
	73	Al aleado Si > 1.5 % - < 10 %	Al alloyed Si > 1.5 % - < 10 %	< 120	< 400		OE
	74	Al aleado Si > 10 %, Aleaciones Magnesio	Al alloyed Si > 10 %, Mg-alloys	< 120	< 400		OE
80 Materiales plásticos Plastic compounds	81	Materiales termoplásticos	Thermoplastics	-	-		E
	82	Materiales duroplásticos	Duroplastics	-	-		E
	83	Materiales plásticos reforzados por fibras	Glass fibre reinforced plastics	-	-		E
90 Metales preciosos Precious metals	91	Oro amarillo	Yellow gold	-	-		OE
	92	Oro rojo	Red gold	-	-		OE
	93	Oro blanco	White gold	-	-		OE
	94	Plata	Silver	-	-		OE

O Óptimo con aceite de corte
Optimal with cutting oil

O Aceptable con aceite de corte
Suitable with cutting oil

E Óptimo con emulsión
Optimal with emulsion

E Aceptable con emulsión
Suitable with emulsion

ZBCF

ZBCF6065VS

ZBCF6067VS



VS

VS

Avance fz
(mm/diente)

Milling fz
(mm/tooth)

Vc (m/min)		Avance fz (mm/diente)	Milling fz (mm/tooth)	
Estándar Standard	Recub. Coated			
	50-100	0.02-0.06		11
	50-100	0.01-0.05		12
	50-100	0.01-0.05		13
	50-100	0.01-0.05		14
	40-80	0.01-0.05		15
	30-60	0.008-0.04		16
	30-60	0.006-0.025		17
				18
	40-80	0.01-0.04		21
	30-50	0.01-0.04		22
	30-60	0.01-0.04		23
	30-50	0.01-0.03		24
	70-140	0.01-0.05		31
	50-100	0.01-0.05		32
	30-50	0.01-0.04		41
	30-50	0.01-0.04		42
	40-60	0.01-0.03		51
	30-50	0.01-0.03		52
	30-50	0.005-0.03		53
				61
	100-200	0.01-0.05		62
	100-200	0.01-0.05		63
	100-200	0.01-0.05		71
	100-200	0.01-0.05		72
	100-200	0.01-0.05		73
	70-140	0.01-0.05		74
	80-180	0.05-0.10		81
	80-180	0.02-0.08		82
	50-150	0.02-0.10		83
	80-120	0.02-0.08		91
	50-100	0.01-0.05		92
	40-80	0.01-0.04		93
	50-100	0.01-0.05		94



A Óptimo con aire
Optimal with air

A Aceptable con aire
Suitable with air

Los valores son indicativos.
The indicated values are a guideline.

TABLA DE UTILIZACIÓN C315VS — APPLICATION CHART C315VS

Ciclo de programación para punta de centrar C315VS Programming cycle for spotting drills C315VS

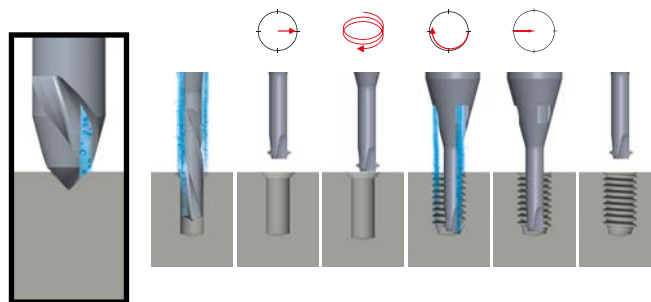

DC Tabla de utilización para punta de centrar **DC** Application chart for spotting drills

Grupos de materiales Material groups	Clasificación de los materiales	Material designation	Dureza Hardness (HB)	Resistencia Tensile strength Rm (N/mm ²)	Lubricante Lubricant		
					Estándar Standard	Recub. Coated	
10 Aceros Steels	11	Aceros de decoletaje	Free-cutting steels	< 200	< 700		OE
	12	Aceros de construcción o de cementación	Structural, cementation steels	< 200	< 700		OE
	13	Aceros al carbón	Carbon steels	< 300	< 1000		OE
	14	Aceros aleados < 850 N/mm ²	Alloy steels < 850 N/mm ²	< 250	< 850		OE
	15	Aceros aleados/trat. > 850 - < 1150 N/mm ²	Alloy steels hard./ temp. > 850 - < 1150 N/mm ²	> 250	> 850		OE
	16	Aceros de alta resistencia ≤ 44 HRC	High tensile alloy steels ≤ 44 HRC	> 250	> 850		OE
	17	Aceros templados y revenidos > 44 - ≤ 54 HRC	Alloy steels tempered > 44 - ≤ 54 HRC	> 410	> 1400		OE
	18	Aceros templados > 54 - ≤ 63 HRC	Alloy steels hardened > 54 - ≤ 63 HRC	> 560	> 1980		
20 Aceros inoxidables Stainless steels	21	Aceros inoxidables al azufre	Free machining stainless steels	< 250	< 850		OE
	22	Austeníticos	Austenitic stainless steels	< 250	< 850		OE
	23	Ferríticos y martensíticos < 850 N/mm ²	Ferritic and martensitic < 850 N/mm ²	< 250	< 850		OE
	24	Ferríticos y martensíticos > 850 - < 1150 N/mm ²	Ferritic and martensitic > 850 - < 1150 N/mm ²	> 250	> 850		OE
30 Fundición Cast iron	31	Fundición gris	Cast iron	< 250	< 850		OE
	32	Fundición de grafito + esferoidal y maleable	Spheroidal graphite + malleable cast iron	< 250	< 850		OE
40 Titanio Titanium	41	Titanio puro	Pure titanium	< 250	< 850		OE
	42	Aleación al titanio	Titanium alloys	> 250	> 850		OE
50 Níquel Nickel	51	Aleación al Níquel 1 ≤ 850 N/mm ²	Nickel alloys 1 ≤ 850 N/mm ²	< 250	< 850		OE
	52	Aleación al Níquel 2 > 850 - ≤ 1150 N/mm ²	Nickel alloys 2 > 850 - ≤ 1150 N/mm ²	> 250	> 850		OE
	53	Aleación al Níquel 3 > 1150 - ≤ 1600 N/mm ²	Nickel alloys 3 > 1150 - ≤ 1600 N/mm ²	> 340	> 1150		OE
60 Cobre Copper	61	Cobre puro (electrolítico)	Pure copper (electrolytic copper)	< 120	< 400		OE
	62	Latón, bronce (virutas cortas)	Short chip brass, phosphor bronze, gun metal	< 200	< 700		OE
	63	Latón (virutas largas)	Long chip brass	< 200	< 700		OE
70 Aluminio Magnesio Aluminium Magnesium	71	Al no aleado	Al unalloyed	< 100	< 350		OE
	72	Al aleado Si < 1.5 %	Al alloyed Si < 1.5 %	< 150	< 500		OE
	73	Al aleado Si > 1.5 % - < 10 %	Al alloyed Si > 1.5 % - < 10 %	< 120	< 400		OE
	74	Al aleado Si > 10 %, Aleaciones Magnesio	Al alloyed Si > 10 %, Mg-alloys	< 120	< 400		OE
80 Materiales plásticos Plastic compounds	81	Materiales termoplásticos	Thermoplastics	-	-		E
	82	Materiales duroplásticos	Duroplastics	-	-		E
	83	Materiales plásticos reforzados por fibras	Glass fibre reinforced plastics	-	-		E
90 Metales preciosos Precious metals	91	Oro amarillo	Yellow gold	-	-		OE
	92	Oro rojo	Red gold	-	-		OE
	93	Oro blanco	White gold	-	-		OE
	94	Plata	Silver	-	-		OE

O Óptimo con aceite de corte
Optimal with cutting oil

o Aceptable con aceite de corte
Suitable with cutting oil

E Óptimo con emulsión
Optimal with emulsion

e Aceptable con emulsión
Suitable with emulsion

G315VS



Vc (m/min)		Avance f (mm/rev.)				Feed rate f (mm/rev.)		
Estándar Standard	Recub. Coated	Ø 1.40	Ø 2.00	Ø 3.00	Ø 4.00	Ø 6.00	Ø 8.00	
	120	0.05	0.08	0.10	0.12	0.15	0.20	11
	120	0.05	0.08	0.10	0.12	0.15	0.20	12
	120	0.05	0.08	0.10	0.12	0.15	0.20	13
	80	0.05	0.08	0.10	0.12	0.15	0.20	14
	60	0.03	0.04	0.06	0.08	0.12	0.18	15
	40	0.02	0.03	0.04	0.05	0.06	0.07	16
	40	0.02	0.03	0.04	0.05	0.06	0.07	17
								18
	60	0.03	0.04	0.06	0.08	0.12	0.18	21
	50	0.03	0.04	0.06	0.07	0.09	0.11	22
	50	0.03	0.04	0.06	0.07	0.09	0.11	23
	50	0.03	0.04	0.06	0.07	0.09	0.11	24
	100	0.04	0.05	0.07	0.09	0.11	0.15	31
	100	0.04	0.05	0.07	0.09	0.11	0.15	32
	25	0.03	0.04	0.06	0.07	0.09	0.11	41
	25	0.04	0.07	0.09	0.11	0.14	0.18	42
	25	0.025	0.03	0.04	0.05	0.07	0.09	51
	20	0.025	0.03	0.04	0.05	0.07	0.09	52
	10	0.025	0.03	0.04	0.05	0.07	0.09	53
	100	0.06	0.09	0.11	0.13	0.18	0.23	61
	100	0.06	0.09	0.11	0.13	0.16	0.18	62
	80	0.06	0.09	0.11	0.13	0.16	0.18	63
	150	0.06	0.09	0.11	0.13	0.18	0.23	71
	150	0.06	0.09	0.11	0.13	0.18	0.23	72
	100	0.06	0.09	0.11	0.13	0.18	0.23	73
	100	0.06	0.09	0.11	0.13	0.18	0.23	74
	200	0.08	0.11	0.13	0.15	0.20	0.25	81
	200	0.08	0.11	0.13	0.15	0.20	0.25	82
	100	0.08	0.11	0.13	0.15	0.20	0.25	83
	200	0.08	0.11	0.13	0.15	0.20	0.25	91
	150	0.08	0.11	0.13	0.15	0.20	0.25	92
	100	0.08	0.11	0.13	0.15	0.20	0.25	93
	100	0.08	0.11	0.13	0.15	0.20	0.25	94

A Óptimo con aire
Optimal with air

A Aceptable con aire
Suitable with air

Los valores son indicativos.
The indicated values are a guideline.



TABLA DE UTILIZACIÓN FZ315VS — APPLICATION CHART FZ315VS

Ciclo de programación para brocas de taladrar FZ315VS Programming cycle for twist drills FZ315VS

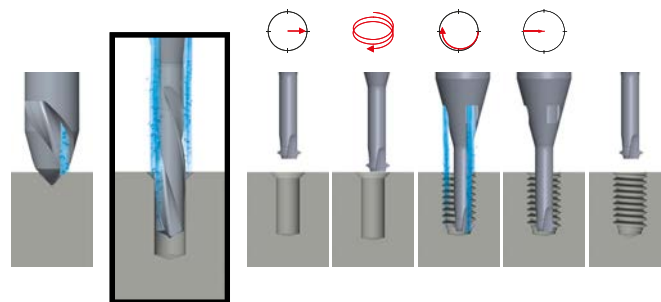

DC Tabla de utilización para brocas de taladrar **DC** Application chart for twist drills

Grupos de materiales Material groups	Clasificación de los materiales	Material designation	Dureza Hardness (HB)	Resistencia Tensile strength Rm (N/mm ²)	Lubricante Lubricant		
					Estándar Standard	Recub. Coated	
10 Aceros Steels	11	Aceros de decoletaie	Free-cutting steels	< 200	< 700		OE
	12	Aceros de construcción o de cementación	Structural, cementation steels	< 200	< 700		OE
	13	Aceros al carbón	Carbon steels	< 300	< 1000		OE
	14	Aceros aleados < 850 N/mm ²	Alloy steels < 850 N/mm ²	< 250	< 850		OE
	15	Aceros aleados/trat. > 850 - < 1150 N/mm ²	Alloy steels hard. / temp. > 850 - < 1150 N/mm ²	> 250	> 850		OE
	16	Aceros de alta resistencia ≤ 44 HRC	High tensile alloy steels ≤ 44 HRC	> 250	> 850		OE
	17	Aceros templados y revenidos > 44 - ≤ 54 HRC	Alloy steels tempered > 44 - ≤ 54 HRC	> 410	> 1400		OE
	18	Aceros templados > 54 - ≤ 63 HRC	Alloy steels hardened > 54 - ≤ 63 HRC	> 560	> 1980		
20 Aceros inoxidables Stainless steels	21	Aceros inoxidables al azufre	Free machining stainless steels	< 250	< 850		OE
	22	Austeníticos	Austenitic stainless steels	< 250	< 850		OE
	23	Ferríticos y martensíticos < 850 N/mm ²	Ferritic and martensitic < 850 N/mm ²	< 250	< 850		OE
	24	Ferríticos y martensíticos > 850 - < 1150 N/mm ²	Ferritic and martensitic > 850 - < 1150 N/mm ²	> 250	> 850		OE
30 Fundición Cast iron	31	Fundición gris	Cast iron	< 250	< 850		OE
	32	Fundición de grafito + esferoidal y maleable	Spheroidal graphite + malleable cast iron	< 250	< 850		OE
40 Titanio Titanium	41	Titanio puro	Pure titanium	< 250	< 850		OE
	42	Aleación al titanio	Titanium alloys	> 250	> 850		OE
50 Níquel Nickel	51	Aleación al Níquel 1 ≤ 850 N/mm ²	Nickel alloys 1 ≤ 850 N/mm ²	< 250	< 850		OE
	52	Aleación al Níquel 2 > 850 - ≤ 1150 N/mm ²	Nickel alloys 2 > 850 - ≤ 1150 N/mm ²	> 250	> 850		OE
	53	Aleación al Níquel 3 > 1150 - ≤ 1600 N/mm ²	Nickel alloys 3 > 1150 - ≤ 1600 N/mm ²	> 340	> 1150		OE
60 Cobre Copper	61	Cobre puro (electrolítico)	Pure copper (electrolytic copper)	< 120	< 400		OE
	62	Latón, bronce (virutas cortas)	Short chip brass, phosphor bronze, gun metal	< 200	< 700		OE
	63	Latón (virutas largas)	Long chip brass	< 200	< 700		OE
70 Aluminio Magnesio Aluminium Magnesium	71	Al no aleado	Al unalloyed	< 100	< 350		OE
	72	Al aleado Si < 1.5 %	Al alloyed Si < 1.5 %	< 150	< 500		OE
	73	Al aleado Si > 1.5 % - < 10 %	Al alloyed Si > 1.5 % - < 10 %	< 120	< 400		OE
	74	Al aleado Si > 10 %, Aleaciones Magnesio	Al alloyed Si > 10 %, Mg-alloys	< 120	< 400		OE
80 Materiales plásticos Plastic compounds	81	Materiales termoplásticos	Thermoplastics	-	-		E
	82	Materiales duroplásticos	Duroplastics	-	-		E
	83	Materiales plásticos reforzados por fibras	Glass fibre reinforced plastics	-	-		E
90 Metales preciosos Precious metals	91	Oro amarillo	Yellow gold	-	-		OE
	92	Oro rojo	Red gold	-	-		OE
	93	Oro blanco	White gold	-	-		OE
	94	Plata	Silver	-	-		OE

O Óptimo con aceite de corte
Optimal with cutting oil

O Aceptable con aceite de corte
Suitable with cutting oil

E Óptimo con emulsión
Optimal with emulsion

E Aceptable con emulsión
Suitable with emulsion

FZ315VS



Vc (m/min) Ø 0.58 - 2.0		Avance f (mm/rev.)				Feed rate f (mm/rev.)	
Estándar Standard	Recub. Coated	Ø0.58-0.82	Ø0.83-1.07	Ø1.08-1.46	Ø1.47-2.0	Q1	Qx
	40-60	0.02-0.035	0.03-0.045	0.04-0.055	0.05-0.065	1xd,-4xd	1xd,-2xd
	40-60	0.02-0.035	0.03-0.045	0.04-0.055	0.05-0.065	1xd,-4xd	1xd,-2xd
	35-55	0.015-0.025	0.025-0.035	0.035-0.045	0.045-0.055	1xd,-4xd	1xd,-2xd
	35-55	0.015-0.025	0.025-0.035	0.035-0.045	0.045-0.055	1xd,-4xd	1xd,-2xd
	35-55	0.015-0.025	0.025-0.035	0.035-0.045	0.045-0.055	1xd,-4xd	1xd,-2xd
	35-55	0.015-0.025	0.025-0.035	0.035-0.045	0.045-0.055	1xd,-4xd	1xd,-2xd
	30-45	0.015-0.025	0.025-0.035	0.035-0.045	0.045-0.055	1xd,-4xd	1xd,-2xd
	30-45	0.015-0.025	0.025-0.035	0.035-0.045	0.045-0.055	1xd,-4xd	1xd,-2xd
	30-45	0.015-0.025	0.025-0.035	0.035-0.045	0.045-0.055	1xd,-4xd	1xd,-2xd
	35-50	0.02-0.025	0.025-0.035	0.04-0.05	0.05-0.065	1xd,-4xd	1xd,-2xd
	35-50	0.02-0.025	0.025-0.035	0.04-0.05	0.05-0.065	1xd,-4xd	1xd,-2xd
	50-80	0.025-0.045	0.045-0.065	0.065-0.085	0.085-0.10	4xd,-8xd	4xd
	40-70	0.025-0.045	0.045-0.065	0.065-0.085	0.085-0.10	4xd,-8xd	4xd
	15-25	0.005-0.02	0.015-0.045	0.04-0.06	0.055-0.07	1/2xd,-1xd	1/4xd,-1/2xd
	15-25	0.005-0.02	0.015-0.045	0.04-0.06	0.055-0.07	1/2xd,-1xd	1/4xd,-1/2xd
	15-25	0.005-0.02	0.02-0.025	0.025-0.035	0.035-0.05	1/2xd,-1xd	1/2xd
	15-25	0.015-0.02	0.02-0.025	0.025-0.035	0.035-0.05	1/2xd,-1xd	1/2xd
	15-25	0.005-0.01	0.01-0.02	0.02-0.03	0.03-0.04	1/2xd,-1xd	1/2xd
	50-80	0.05-0.08	0.06-0.10	0.08-0.12	0.12-0.15	4xd,-8xd	4xd
	50-80	0.05-0.08	0.06-0.10	0.08-0.12	0.12-0.15	4xd,-8xd	4xd
	50-80	0.05-0.08	0.06-0.10	0.08-0.12	0.12-0.15	4xd,-8xd	4xd
	50-80	0.05-0.08	0.06-0.10	0.08-0.12	0.12-0.15	2xd,-3xd	3xd
	50-80	0.05-0.08	0.06-0.10	0.08-0.12	0.12-0.15	2xd,-3xd	3xd
	50-80	0.05-0.08	0.06-0.10	0.08-0.12	0.12-0.15	2xd,-3xd	3xd
	50-80	0.05-0.08	0.06-0.10	0.08-0.12	0.12-0.15	4xd,-8xd	4xd
	50-80	0.05-0.08	0.06-0.10	0.08-0.12	0.12-0.15	4xd,-8xd	4xd
	40-60	0.02-0.035	0.03-0.045	0.04-0.055	0.05-0.065	2xd,-3xd	3xd
	50-80	0.02-0.035	0.03-0.045	0.04-0.055	0.05-0.065	2xd,-3xd	3xd
	50-80	0.02-0.035	0.03-0.045	0.04-0.055	0.05-0.065	2xd,-3xd	3xd
	40-60	0.02-0.035	0.03-0.045	0.04-0.055	0.05-0.065	2xd,-3xd	3xd
	40-60	0.02-0.035	0.03-0.045	0.04-0.055	0.05-0.065	2xd,-3xd	3xd

A Óptimo con aire
Optimal with air

A Aceptable con aire
Suitable with air

FZ315VS

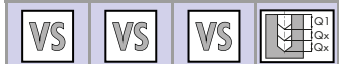

Vc (m/min) Ø 2.01 - 5.4		Avance f (mm/rev.)			Feed rate f (mm/rev.)
Estándar Standard	Recub. Coated	Ø2.01-3.05	Ø3.06-4.5	Ø4.51-5.4	Qx
	80-110	0.07-0.12	0.12-0.18	0.18-0.23	
	80-110	0.07-0.12	0.12-0.17	0.17-0.22	
	70-100	0.07-0.12	0.12-0.17	0.17-0.22	
	70-100	0.07-0.12	0.12-0.17	0.17-0.22	
	70-100	0.07-0.12	0.12-0.17	0.17-0.22	
	70-100	0.07-0.12	0.12-0.17	0.17-0.22	
	70-100	0.07-0.10	0.10-0.14	0.14-0.17	
	60-80	0.07-0.10	0.10-0.15	0.14-0.18	
	60-80	0.045-0.055	0.055-0.07	0.07-0.10	
	60-80	0.045-0.055	0.055-0.07	0.07-0.10	
	60-80	0.05-0.065	0.05-0.065	0.06-0.09	
	60-80	0.05-0.065	0.05-0.065	0.06-0.09	
	90-130	0.10-0.15	0.15-0.20	0.20-0.25	
	80-120	0.10-0.14	0.14-0.18	0.18-0.23	
	30-40	0.055-0.07	0.055-0.07	0.055-0.07	1/3xd,-1/2xd
	30-40	0.055-0.07	0.055-0.07	0.055-0.07	1/3xd,-1/2xd
	30-40	0.035-0.05	0.035-0.05	0.05-0.08	
	30-40	0.035-0.05	0.035-0.05	0.05-0.08	
	30-40	0.03-0.04	0.03-0.04	0.04-0.06	
	130-180	0.12-0.15	0.15-0.20	0.20-0.25	
	130-180	0.12-0.15	0.15-0.20	0.20-0.25	
	80-110	0.12-0.15	0.14-0.18	0.18-0.23	
	130-180	0.12-0.15	0.15-0.20	0.20-0.25	
	130-180	0.12-0.15	0.15-0.20	0.20-0.25	
	100-130	0.12-0.15	0.14-0.18	0.18-0.23	
	100-130	0.12-0.15	0.14-0.18	0.18-0.23	
	130-180	0.12-0.15	0.15-0.20	0.20-0.25	
	130-180	0.12-0.15	0.15-0.20	0.20-0.25	
	80-120	0.07-0.12	0.12-0.18	0.18-0.23	
	130-180	0.07-0.12	0.12-0.17	0.17-0.22	
	130-180	0.07-0.12	0.12-0.17	0.17-0.22	
	80-110	0.07-0.12	0.12-0.17	0.17-0.22	
	80-110	0.07-0.12	0.12-0.17	0.17-0.22	

Los valores son indicativos.
The indicated values are a guideline.

TABLA DE UTILIZACIÓN F286VS — APPLICATION CHART F286VS

DC Tabla de utilización para brocas de taladrar DC Application chart for twist drills

Grupos de materiales Material groups	Clasificación de los materiales	Material designation	Dureza Hardness (HB)	Resistencia Tensile strength Rm (N/mm ²)	Lubricante Lubricant	
					Estándar Standard	Recub. Coated
10 Aceros Steels	11 Aceros de decoletaje	Free-cutting steels	< 200	< 700		OE
	12 Aceros de construcción o de cementación	Structural, cementation steels	< 200	< 700		OE
	13 Aceros al carbón	Carbon steels	< 300	< 1000		OE
	14 Aceros aleados < 850 N/mm ²	Alloy steels < 850 N/mm ²	< 250	< 850		OE
	15 Aceros aleados/trat. > 850 - < 1150 N/mm ²	Alloy steels hard./ temp. > 850 - < 1150 N/mm ²	> 250	> 850		OE
	16 Aceros de alta resistencia ≤ 44 HRC	High tensile alloy steels ≤ 44 HRC	> 250	> 850		
	17 Aceros templados y revenidos > 44 - ≤ 54 HRC	Alloy steels tempered > 44 - ≤ 54 HRC	> 410	> 1400		
	18 Aceros templados > 54 - ≤ 63 HRC	Alloy steels hardened > 54 - ≤ 63 HRC	> 560	> 1980		
20 Aceros inoxidables Stainless steels	21 Aceros inoxidables al azufre	Free machining stainless steels	< 250	< 850		OE
	22 Austeníticos	Austenitic stainless steels	< 250	< 850		OE
	23 Ferríticos y martensíticos < 850 N/mm ²	Ferritic and martensitic < 850 N/mm ²	< 250	< 850		OE
	24 Ferríticos y martensíticos > 850 - < 1150 N/mm ²	Ferritic and martensitic > 850 - < 1150 N/mm ²	> 250	> 850		OE
30 Fundición Cast iron	31 Fundición gris	Cast iron	< 250	< 850		
	32 Fundición de grafito + esferoidal y maleable	Spheroidal graphite + malleable cast iron	< 250	< 850		
40 Titanio Titanium	41 Titanio puro	Pure titanium	< 250	< 850		OE
	42 Aleación al titanio	Titanium alloys	> 250	> 850		
50 Níquel Nickel	51 Aleación al Níquel 1 ≤ 850 N/mm ²	Nickel alloys 1 ≤ 850 N/mm ²	< 250	< 850		OE
	52 Aleación al Níquel 2 > 850 - ≤ 1150 N/mm ²	Nickel alloys 2 > 850 - ≤ 1150 N/mm ²	> 250	> 850		
	53 Aleación al Níquel 3 > 1150 - ≤ 1600 N/mm ²	Nickel alloys 3 > 1150 - ≤ 1600 N/mm ²	> 340	> 1150		
60 Cobre Copper	61 Cobre puro (electrolítico)	Pure copper (electrolytic copper)	< 120	< 400		OE
	62 Latón, bronce (virutas cortas)	Short chip brass, phosphor bronze, gun metal	< 200	< 700		
	63 Latón (virutas largas)	Long chip brass	< 200	< 700		OE
70 Aluminio Magnesio Aluminium Magnesium	71 Al no aleado	Al unalloyed	< 100	< 350		OE
	72 Al aleado Si < 1.5 %	Al alloyed Si < 1.5 %	< 150	< 500		OE
	73 Al aleado Si > 1.5 % - < 10 %	Al alloyed Si > 1.5 % - < 10 %	< 120	< 400		OE
	74 Al aleado Si > 10 %, Aleaciones Magnesio	Al alloyed Si > 10 %, Mg-alloys	< 120	< 400		
80 Materiales plásticos Plastic compounds	81 Materiales termoplásticos	Thermoplastics	-	-		
	82 Materiales duroplásticos	Duroplastics	-	-		
	83 Materiales plásticos reforzados por fibras	Glass fibre reinforced plastics	-	-		
90 Metales preciosos Precious metals	91 Oro amarillo	Yellow gold	-	-		
	92 Oro rojo	Red gold	-	-		
	93 Oro blanco	White gold	-	-		OE
	94 Plata	Silver	-	-		OE

 Óptimo con aceite de corte
Optimal with cutting oil

 Aceptable con aceite de corte
Suitable with cutting oil

 Óptimo con emulsión
Optimal with emulsion

 Aceptable con emulsión
Suitable with emulsion

F286VS



V _c (m/min)		VS						
		Avance f (mm/rev.)			Feed rate f (mm/rev.)			
		Ø 0.8 - 1.2	Ø 1.21 - 3.0	Ø 3.01 - 6.0	Ø 6.01 - 8.5	Ø 8.51 - 11.0	Ø 11.02 - 14.0	
Estándar Standard	Recub. Coated							
	70-90	0.015-0.025	0.015-0.025	0.035-0.045	0.11-0.13	0.15-0.17	0.18-0.22	11
	70-90	0.10-0.20	0.015-0.025	0.035-0.045	0.11-0.13	0.15-0.17	0.18-0.22	12
	70-90	0.10-0.20	0.015-0.025	0.035-0.045	0.11-0.13	0.15-0.17	0.18-0.22	13
	70-90	0.10-0.20	0.015-0.025	0.035-0.045	0.11-0.13	0.15-0.17	0.18-0.22	14
	60-80	0.10-0.20	0.015-0.025	0.035-0.045	0.07-0.09	0.11-0.13	0.15-0.17	15
								16
								17
								18
	40-60	0.008-0.012	0.015-0.02	0.035-0.04	0.075-0.085	0.095-0.105	0.15-0.16	21
	40-60	0.008-0.012	0.015-0.02	0.035-0.04	0.075-0.085	0.095-0.105	0.15-0.16	22
	40-60	0.008-0.012	0.015-0.02	0.035-0.04	0.075-0.085	0.095-0.105	0.15-0.16	23
	40-60	0.008-0.012	0.015-0.02	0.035-0.04	0.075-0.085	0.095-0.105	0.15-0.16	24
								31
								32
	40-80	0.003-0.006	0.008-0.012	0.01-0.018	0.025-0.03	0.055-0.06	0.075-0.085	41
								42
	30-50	0.008-0.012	0.015-0.02	0.035-0.04	0.075-0.085	0.095-0.105	0.11-0.13	51
								52
								53
	70-150	0.15-0.25	0.035-0.045	0.055-0.065	0.11-0.13	0.15-0.17	0.18-0.22	61
								62
	70-150	0.15-0.25	0.035-0.045	0.055-0.065	0.11-0.13	0.15-0.17	0.18-0.22	63
	100-160	0.025-0.035	0.045-0.055	0.075-0.085	0.15-0.17	0.22-0.26	0.30-0.34	71
	100-160	0.025-0.035	0.045-0.055	0.075-0.085	0.15-0.17	0.22-0.26	0.30-0.34	72
	60-130	0.02-0.03	0.035-0.045	0.055-0.065	0.11-0.13	0.16-0.20	0.22-0.26	73
								74
								81
								82
								83
								91
								92
	40-60	0.008-0.012	0.015-0.02	0.035-0.04	0.075-0.085	0.095-0.105	0.15-0.16	93
	40-60	0.008-0.012	0.015-0.02	0.035-0.04	0.075-0.085	0.095-0.105	0.15-0.16	94

A Óptimo con aire
Optimal with air

A Aceptable con aire
Suitable with air

Los valores son indicativos.
The indicated values are a guideline.













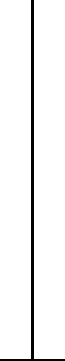





Directorio - Fresas torbellino en metal duro integral tipo GW
Directory - Solid carbide thread whirl cutters type GW

		GW										
Tipo Type	GW1116	GW1116VS	GW2016	GW2016VS	GW3016	GW3016VS	GW3016VX	GW3017	GW3017VS	GW3017VX	GW3019	GW3019VS
Recubrimiento Coating		VS		VS		VS	VX		VS	VX		VS
Longitud roscada Thread length												
Características Characteristics												
M ISO DIN 14 ISO DIN 13	44	44	47	47	50	50	50	51	51	51	52	52
MF ISO DIN 13					53	53	53	54	54	54	55	55
UNC ASME B1.1					56	56	56	57	57	57	58	58
UNF ASME B1.1					59	59	59	60	60	60	61	61
S NIHS 06-10	45	45	48	48	62	62	62	63	63	63	64	64
SL SL 15-01	46	46	49	49	62	62						

Directorio - Fresas torbellino en metal duro integral tipo GWi - GWH, fresas de taladro y roscado circular tipo ZBGF
Directory - Solid carbide thread whirl cutters type GWi - GWH, circular drill thread milling cutters type ZBGF

		GWi						GWH		ZBGF		
Tipo Type		GWi3066VS	GWi3066VX	GWi3067VS	GWi3067VX	GWi3069VS	GWi5066VS	GWi5067VS	GWH3015VH	GWH3017VH	ZBGF6065VS	ZBGF6067VS
Recubrimiento Coating		VS	VX	VS	VX	VS	VS	VS	VH	VH	VS	VS
Longitud roscada Thread length												
Características Characteristics												
M	ISO DIN 14 ISO DIN 13	65	65	66	66	68	82	82	89	89	90	90
MJ	ISO 5855			67	67							
MF	ISO DIN 13	69	69	70	70	72						
MJF	ISO 5855			71	71							
UNC	ASME B1.1	73	73	74	74	76	83	83			91	91
UNJC	ISO 3161			75	75							
UNF	ASME B1.1	77	77	78	78	80	84	84			92	92
UNJF	ISO 3161			79	79							
S	NIHS 06-10	81	81	81	81		85					

Directorio - Punta de centrar tipo C, Brocas de taladrar tipo FZ-F, en metal duro integral
Directory - Solid carbide spotting drills type C, solid carbide twist drills type FZ - F

	C	FZ		F
Tipo Type	C315VS	FZ315VS	FZ315VS	F286VS
Recubrimiento Coating	VS	VS	VS	VS
				
Profundidad de taladrado Drilling depth		8xd, 	6xd, 	5xd, 
Características Characteristics	  	 	  	   
C315VS	86			
FZ315VS		87	87	
F286VS				88

BESTSELLER

**PODEIS ENCONTRAR NUESTRO CATÁLOGO
"BESTSELLER" EN NUESTRO WEBSITE:
DCSWISS.COM/ES/DESCARGA**



BESTSELLER

**YOU FIND OUR BESTSELLER CATALOGUE ON OUR
WEBSITE: DCSWISS.COM/EN/DOWNLOAD**

GW

GW1116

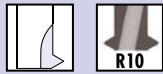

GW1116VS



GW1116

GW1116VS

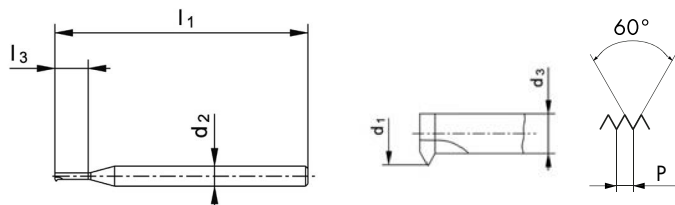
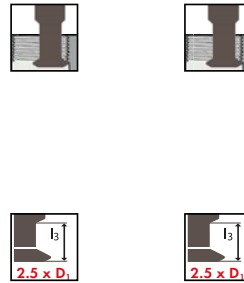

$\frac{\theta}{M}$	D_1	P	d_1	l_1	l_3	d_2 h5	d_3			ID	ID	
0.3	0.08	0.21	39	0.9	3	0.1	1	0.23	●	194227	●	194245
0.35	0.09	0.25	39	1	3	0.13	1	0.28	●	194228	●	194246
0.4	0.1	0.29	39	1.2	3	0.15	1	0.32 ¹	●	194229	●	194247
0.5	0.125	0.36	39	1.5	3	0.19	1	0.41 ¹	●	194230	●	194248
0.6	0.15	0.43	39	1.7	3	0.23	1	0.5 ¹	●	194231	●	194249
0.7	0.175	0.5	39	2	3	0.27	1	0.58 ¹	●	194232	●	194250
0.8	0.2	0.57	39	2.3	3	0.31	1	0.66 ¹	●	194233	●	194251
0.9	0.225	0.64	39	2.6	3	0.34	1	0.74 ¹	●	194234	●	194252
1	0.25	0.71	39	2.9	3	0.38	1	0.75	●	194235	●	194253
1.2	0.25	0.91	39	3.4	3	0.58	1	0.95	●	194236	●	194254
1.4	0.3	1.06	39	3.9	3	0.66	1	1.1	●	194237	●	194255

¹ 4H5H → 4H6H = +0.02mm

GW

GW1116



GW1116VS



GW1116

GW1116VS

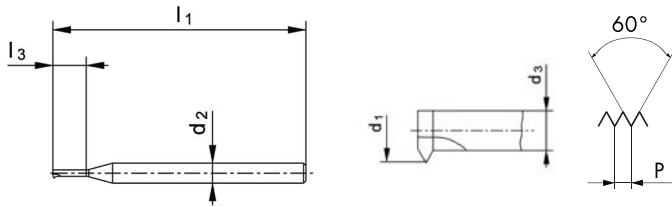
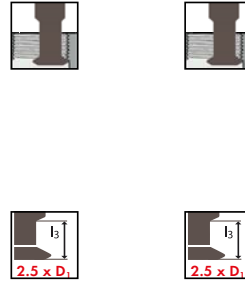

$\frac{\emptyset D_1}{S}$	P mm	d_1 mm	l_1 mm	l_3 mm	d_2 h5 mm	d_3 mm			ID	ID
0.3	0.08	0.21	39	0.9	3	0.1	1	0.23	● 166930	● 166940
0.35	0.09	0.25	39	1	3	0.13	1	0.28	● 194226	● 194244
0.4	0.1	0.29	39	1.2	3	0.15	1	0.32 ¹	● 166931	● 166941
0.5	0.125	0.36	39	1.5	3	0.19	1	0.41 ¹	● 166932	● 166942
0.6	0.15	0.43	39	1.7	3	0.23	1	0.5 ¹	● 166933	● 166943
0.7	0.175	0.5	39	2	3	0.27	1	0.58 ¹	● 166934	● 166944
0.8	0.2	0.57	39	2.3	3	0.31	1	0.66 ¹	● 166935	● 166945
0.9	0.225	0.64	39	2.6	3	0.34	1	0.74 ¹	● 166936	● 166946
1	0.25	0.71	39	2.9	3	0.38	1	0.82 ¹	● 166937	● 166947
1.2	0.25	0.91	39	3.4	3	0.58	1	1.02 ¹	● 166938	● 166948
1.4	0.3	1.06	39	3.9	3	0.66	1	1.18 ¹	● 166939	● 166949

¹ 4H5H → 4H6H = +0.02mm

GW

GW1116

GW1116VS

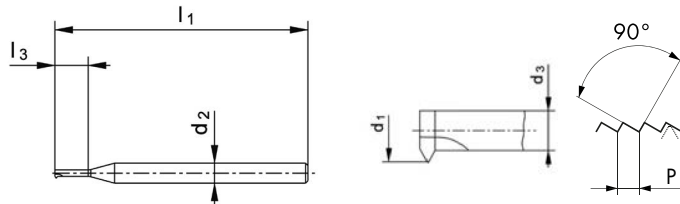
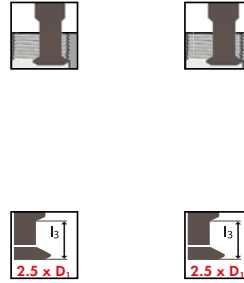
GW1116
GW1116VS

$\emptyset D_1$ SL	P mm	d_1 mm	l_1 mm	l_3 mm	d_2 h5 mm	d_3 mm			ID	ID
0.3	0.06	0.23	39	0.9	3	0.15	1	0.27	● 600017	● 600023
0.35	0.06	0.28	39	1	3	0.2	1	0.32	● 600237	● 600243
0.4	0.08	0.31	39	1.2	3	0.2	1	0.36	● 600018	● 600024
0.5	0.1	0.39	39	1.4	3	0.25	1	0.46	● 600019	● 600025
0.6	0.125	0.46	39	1.7	3	0.29	1	0.55	● 600020	● 600026
0.7	0.15	0.53	39	2	3	0.32	1	0.64	● 600021	● 600027
0.8	0.15	0.63	39	2.2	3	0.42	1	0.74	● 600238	● 600244
0.9	0.175	0.7	39	2.5	3	0.46	1	0.83	● 600239	● 600245
1	0.2	0.77	39	2.8	3	0.49	1	0.92	● 600240	● 600246
1.2	0.2	0.97	39	3.3	3	0.69	1	1.12	● 600241	● 600247
1.4	0.25	1.11	39	3.9	3	0.76	1	1.3	● 600242	● 600248

GW

GW2016



GW2016VS







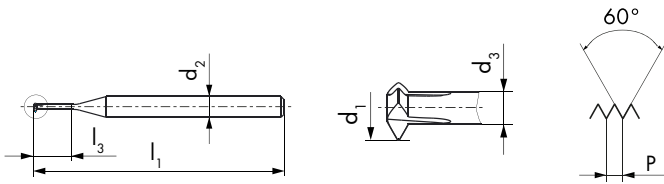
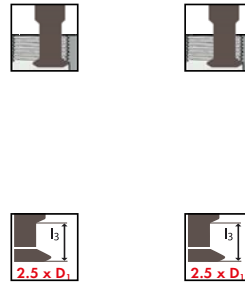



GW2016

GW2016VS

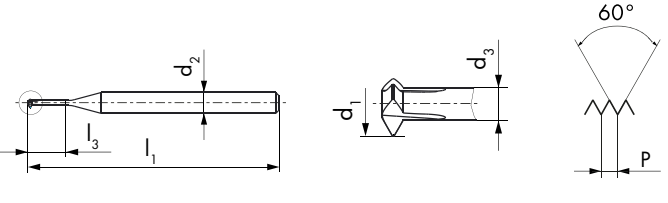
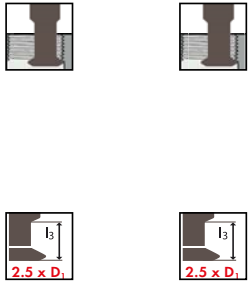

Ø D ₁ M	P mm	d ₁ mm	l ₁ mm	l ₃ mm	d ₂ h5 mm	d ₃ mm			ID	ID
0.5	0.125	0.36	39	1.5	3	0.19	3	0.41 ¹	● 194262	● 194275
0.6	0.15	0.43	39	1.7	3	0.22	3	0.5 ¹	● 194263	● 194276
0.7	0.175	0.5	39	2	3	0.26	3	0.58 ¹	● 194264	● 194277
0.8	0.2	0.57	39	2.3	3	0.29	3	0.66 ¹	● 166974	● 166993
0.9	0.225	0.64	39	2.6	3	0.33	3	0.74 ¹	● 166975	● 166994
1	0.25	0.71	39	2.9	3	0.36	3	0.75	● 166976	● 166995
1.2	0.25	0.91	39	3.4	3	0.56	3	0.95	● 166977	● 166996
1.4	0.3	1.06	39	3.9	3	0.64	3	1.1	● 166978	● 166997
1.6	0.35	1.2	39	4.5	3	0.71	3	1.25	● 166979	● 166998
1.8	0.35	1.4	39	5	3	0.91	3	1.45	● 166980	● 166999
2	0.4	1.54	39	5.6	3	0.98	3	1.6	● 166981	● 167000
2.3	0.4	1.84	39	6.3	3	1.28	3	1.9	● 194265	● 167399
2.5	0.45	1.98	39	6.9	3	1.35	3	2.05	● 166982	● 167001
2.6	0.45	2.08	39	7.1	3	1.45	3	2.15	● 194266	● 194278
3	0.5	2.43	51	8.4	5	1.73	4	2.5	● 166983	● 167002
3.5	0.6	2.81	51	9.9	5	1.97	4	2.9	● 166984	● 167003
4	0.7	3.2	51	11.3	5	2.22	4	3.3	● 166985	● 167004
5	0.8	4.08	51	14	5	2.96	4	4.2	● 166986	● 167005
6	1	4.85	51	16.8	5	3.45	4	5	● 166987	● 167006

¹ 4H5H → 4H6H = +0.02mm

GW										GW2016	GW2016VS		
<p>GW2016  </p> <p>GW2016VS   </p>													
													
$\frac{\theta}{S}$	D_1	P	d_1	l_1	l_3	d_2 h5	d_3			ID	ID		
0.5	0.125	0.36	39	1.5	3	0.19	3	3	0.41 ¹	● 181410	● 181413		
0.6	0.15	0.43	39	1.7	3	0.22	3	3	0.5 ¹	● 181374	● 180947		
0.7	0.175	0.5	39	2	3	0.26	3	3	0.58 ¹	● 181375	● 181378		
0.8	0.2	0.57	39	2.3	3	0.29	3	3	0.66 ¹	● 166969	● 166988		
0.9	0.225	0.64	39	2.6	3	0.33	3	3	0.74 ¹	● 166970	● 166989		
1	0.25	0.71	39	2.9	3	0.36	3	3	0.82 ¹	● 166971	● 166990		
1.2	0.25	0.91	39	3.4	3	0.56	3	3	1.02 ¹	● 166972	● 166991		
1.4	0.3	1.06	39	3.9	3	0.64	3	3	1.18 ¹	● 166973	● 166992		

¹  4H5H → 4H6H = +0.02mm

GW

GW2016



GW2016VS



GW2016

GW2016VS

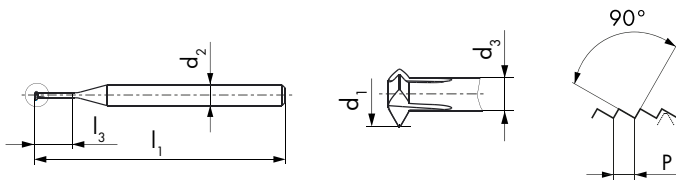
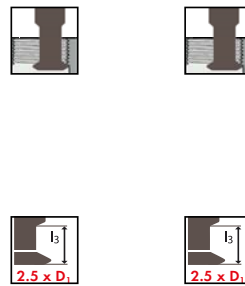

$\emptyset D_1$ SL	P mm	d_1 mm	l_1 mm	l_3 mm	d_2 h5 mm	d_3 mm		
0.5	0.1	0.39	39	1.4	3	0.25	3	0.46
0.6	0.125	0.46	39	1.7	3	0.29	3	0.55
0.7	0.15	0.53	39	2	3	0.32	3	0.64
0.8	0.15	0.63	39	2.2	3	0.42	3	0.74
0.9	0.175	0.7	39	2.5	3	0.46	3	0.83
1	0.2	0.77	39	2.8	3	0.49	3	0.92
1.2	0.2	0.97	39	3.3	3	0.69	3	1.12
1.4	0.25	1.11	39	3.9	3	0.76	3	1.3

ID

ID

● 600249	● 600257
● 600250	● 600258
● 600251	● 600259
● 600252	● 600260
● 600253	● 600261
● 600254	● 600262
● 600255	● 600263
● 600256	● 600264

GW

GW3016



GW3016VS



GW3016VX





GW3016

GW3016VS

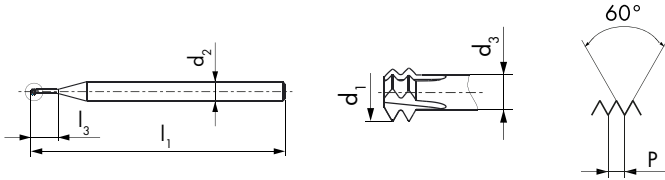
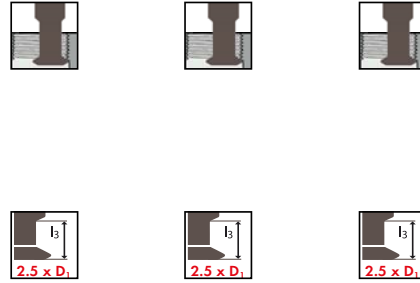
GW3016VX



Ø D ₁ M	P mm	d ₁ mm	l ₁ mm	l ₃ mm	d ₂ h5 mm	d ₃ mm			ID	ID	ID
0.8	0.2	0.57	39	2.3	3	0.29	3	0.66 ¹	● 167021	● 167035	● 187261
0.9	0.225	0.64	39	2.6	3	0.33	3	0.74 ¹	● 167022	● 167036	● 187262
1	0.25	0.71	39	2.9	3	0.36	3	0.75	● 167023	● 167037	● 187263
1.2	0.25	0.91	39	3.4	3	0.56	3	0.95	● 167024	● 167038	● 187264
1.4	0.3	1.06	39	3.9	3	0.64	3	1.1	● 167025	● 167039	● 187265
1.6	0.35	1.2	39	4.5	3	0.71	3	1.25	● 167026	● 167040	● 187266
1.8	0.35	1.4	39	5	3	0.91	3	1.45	● 167027	● 167041	● 187267
2	0.4	1.54	39	5.6	3	0.98	3	1.6	● 167028	● 167042	● 187268
2.3	0.4	1.84	39	6.3	3	1.28	3	1.9	● 196140	● 167296	● 194310
2.5	0.45	1.98	39	6.9	3	1.35	3	2.05	● 167029	● 167043	● 187269
2.6	0.45	2.08	39	7.1	3	1.45	3	2.15	● 196141	● 194290	● 194311
3	0.5	2.43	51	8.4	5	1.73	4	2.5	● 167030	● 167044	● 187270
3.5	0.6	2.81	51	9.9	5	1.97	4	2.9	● 167031	● 167045	● 187271
4	0.7	3.2	51	11.3	5	2.22	4	3.3	● 167032	● 167046	● 187272
5	0.8	4.08	51	14	5	2.96	4	4.2	● 167033	● 167047	● 187273
6	1	4.85	51	16.8	5	3.45	4	5	● 167034	● 167048	● 187274
8	1.25	5.95	63	23	6 ²	4.2	5	6.8	● 175229	● 175243	● 187275
10	1.5	7.95	67	28	8 ²	5.85	5	8.5	● 175230	● 175244	● 187276
12	1.75	9.95	76	34	10 ²	7.5	5	10.2	● 175231	● 175245	● 187277
14	2	10.95	95	44	12 ²	8.15	5	12	● 196142	● 184748	● 187278
16	2	10.95	95	44	12 ²	8.15	5	14	● 196143	● 186813	● 187279
18	2.5	13.95	105	55	14 ²	10.45	6	15.5	● 196144	● 184503	● 187280
20	2.5	13.95	105	55	14 ²	10.45	6	17.5	● 196145	● 186814	● 187281

¹  4H5H → 4H6H = +0.02mm

² Tol. h6

GW

GW3017



GW3017VS



GW3017VX





GW3017

GW3017VS

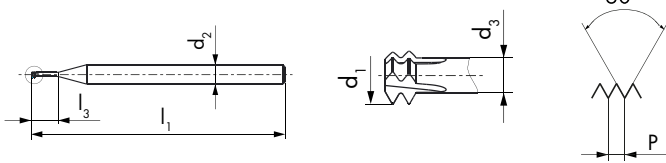
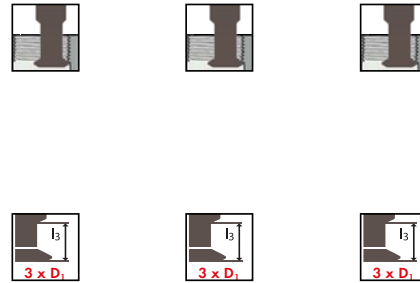
GW3017VX



Ø D ₁ M	P mm	d ₁ mm	l ₁ mm	l ₃ mm	d ₂ h5 mm	d ₃ mm			ID	ID	ID
0.8	0.2	0.57	39	2.7	3	0.29	3	0.66 ¹	● 196172	● 186266	● 187389
0.9	0.225	0.64	39	3	3	0.33	3	0.74 ¹	● 196173	● 186267	● 187390
1	0.25	0.71	39	3.4	3	0.36	3	0.75	● 196189	● 186268	● 187391
1.2	0.25	0.91	39	4	3	0.56	3	0.95	● 196174	● 186269	● 187392
1.4	0.3	1.06	39	4.6	3	0.64	3	1.1	● 196175	● 186270	● 187393
1.6	0.35	1.2	39	5.3	3	0.71	3	1.25	● 196176	● 186271	● 187394
1.8	0.35	1.4	39	5.9	3	0.91	3	1.45	● 196177	● 186272	● 187395
2	0.4	1.54	39	6.6	3	0.98	3	1.6	● 183766	● 186273	● 187396
2.3	0.4	1.84	39	7.5	3	1.28	3	1.9	● 196190	● 194296	● 194317
2.5	0.45	1.98	39	8.1	3	1.35	3	2.05	● 196193	● 186274	● 187397
2.6	0.45	2.08	39	8.4	3	1.45	3	2.15	● 196194	● 194297	● 194318
3	0.5	2.43	51	9.9	5	1.73	4	2.5	● 196201	● 186275	● 187398
3.5	0.6	2.81	51	11.6	5	1.97	4	2.9	● 196199	● 186276	● 187399
4	0.7	3.2	51	13.3	5	2.22	4	3.3	● 196203	● 186277	● 187400
5	0.8	4.08	51	16.5	5	2.96	4	4.2	● 196205	● 186278	● 187401
6	1	4.85	51	19.8	5	3.45	4	5	● 196207	● 186279	● 187402
8	1.25	5.95	75	27	6 ²	4.2	5	6.8	● 196209	● 186280	● 187403
10	1.5	7.95	83	33	8 ²	5.85	5	8.5	● 196180	● 186281	● 187404
12	1.75	9.95	95	40	10 ²	7.5	5	10.2	● 196182	● 186282	● 187405
14	2	10.95	120	52	12 ²	8.15	5	12	● 196184	● 186283	● 187406
16	2	10.95	120	52	12 ²	8.15	5	14	● 196186	● 186821	● 187407
18	2.5	13.95	135	65	14 ²	10.45	6	15.5	● 196188	● 186284	● 187408
20	2.5	13.95	135	65	14 ²	10.45	6	17.5	● 196196	● 186822	● 187409

¹  4H5H → 4H6H = +0.02mm

² Tol. h6

GW

GW3019



GW3019VS



GW3019



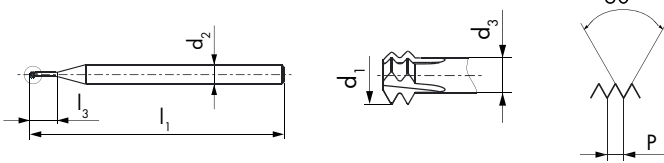















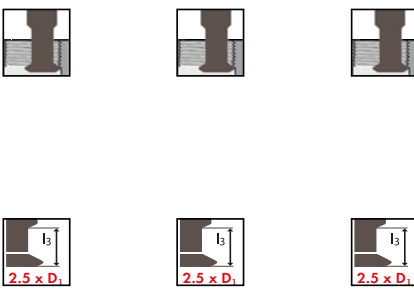
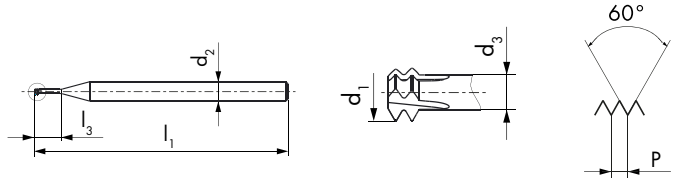







































































GW3019VS



Ø D ₁ M	P mm	d ₁ mm	l ₁ mm	l ₃ mm	d ₂ h5 mm	d ₃ mm			ID	ID
0.8	0.2	0.57	39	3.5	3	0.29	3	0.66 ¹	● 167063	● 167077
0.9	0.225	0.64	39	3.9	3	0.33	3	0.74 ¹	● 167064	● 167078
1	0.25	0.71	39	4.4	3	0.36	3	0.75	● 167065	● 167079
1.2	0.25	0.91	39	5.2	3	0.56	3	0.95	● 167066	● 167080
1.4	0.3	1.06	39	6	3	0.64	3	1.1	● 167067	● 167081
1.6	0.35	1.2	39	6.9	3	0.71	3	1.25	● 167068	● 167082
1.8	0.35	1.4	39	7.7	3	0.91	3	1.45	● 167069	● 167083
2	0.4	1.54	39	8.6	3	0.98	3	1.6	● 167070	● 167084
2.3	0.4	1.84	39	9.8	3	1.28	3	1.9	● 196268	● 194303
2.5	0.45	1.98	39	10.6	3	1.35	3	2.05	● 167071	● 167085
2.6	0.45	2.08	39	11	3	1.45	3	2.15	● 196269	● 194304
3	0.5	2.43	51	12.9	5	1.73	4	2.5	● 167072	● 167086
3.5	0.6	2.81	51	15.1	5	1.97	4	2.9	● 167073	● 167087
4	0.7	3.2	51	17.3	5	2.22	4	3.3	● 167074	● 167088
5	0.8	4.08	51	21.5	5	2.96	4	4.2	● 167075	● 167089
6	1	4.85	51	25.8	5	3.45	4	5	● 167076	● 167090
8	1.25	5.95	75	35	6 ²	4.2	5	6.8	● 175258	● 175274
10	1.5	7.95	83	43	8 ²	5.85	5	8.5	● 175259	● 175275
12	1.75	9.95	95	52	10 ²	7.5	5	10.2	● 175260	● 175276
14	2	10.95	120	68	12 ²	8.15	5	12	● 196243	● 184751
16	2	10.95	120	68	12 ²	8.15	5	14	● 196244	● 186829
18	2.5	13.95	135	85	14 ²	10.45	6	15.5	● 196245	● 184754
20	2.5	13.95	135	85	14 ²	10.45	6	17.5	● 196246	● 186830

¹ 4H5H → 4H6H = +0.02mm

² Tol. h6

<h1>GW</h1>										GW3016	GW3016VS	GW3016VX	
<div style="display: flex; justify-content: space-between;"> <div style="width: 45%;"> <p>GW3016  </p> <p>GW3016VS   </p> <p>GW3016VX   </p> </div> <div style="width: 50%;">  </div> </div>													
													
Ø D ₁ MF	P mm	d ₁ mm	l ₁ mm	l ₃ mm	d ₂ h5 mm	d ₃ mm				ID	ID	ID	
2	0.2	1.77	39	5.3	3	1.49	3	1.8					
2	0.25	1.71	39	5.4	3	1.36	3	1.75					
2.5	0.2	2.27	39	6.6	3	1.99	3	2.3					
2.5	0.25	2.21	39	6.6	3	1.86	3	2.25					
3	0.35	2.6	51	8.2	5	2.11	4	2.65					
4	0.5	3.43	51	10.9	5	2.73	4	3.5					
5	0.5	4.43	51	13.4	5	3.73	4	4.5					
6	0.75	4.95	51	16.4	5	3.9	4	5.25					
8	1	5.95	63	22	6 ¹	4.55	5	7					
10	1	7.95	67	27	8 ¹	6.55	5	9					
10	1.25	7.95	67	28	8 ¹	6.2	5	8.8					
12	1.5	9.95	76	33	10 ¹	7.85	5	10.5					
14	1.5	10.95	95	43	12 ¹	8.85	5	12.5					
16	1.5	10.95	95	43	12 ¹	8.85	5	14.5					
18	1.5	13.95	105	53	14 ¹	11.85	6	16.5					
20	1.5	13.95	105	53	14 ¹	11.85	6	18.5					

¹ Tol. h6

GW

GW3017



GW3017VS



GW3017VX



GW3017

GW3017VS

GW3017VX

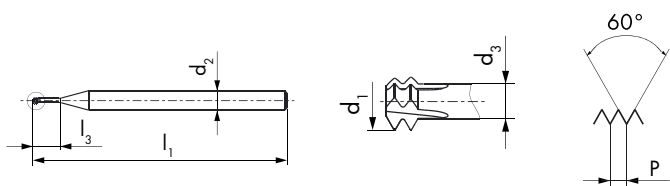

Ø D ₁ MF	P mm	d ₁ mm	l ₁ mm	l ₂ mm	d ₂ h5 mm	d ₃ mm			ID	ID	ID
2	0.2	1.77	39	6.3	3	1.49	3	1.8	● 196197	● 186325	● 187410
2	0.25	1.71	39	6.4	3	1.36	3	1.75	● 196198	● 186326	● 187411
2.5	0.2	2.27	39	7.8	3	1.99	3	2.3	● 196191	● 186327	● 187412
2.5	0.25	2.21	39	7.9	3	1.86	3	2.25	● 196192	● 186328	● 187413
3	0.35	2.6	51	9.7	5	2.11	4	2.65	● 196200	● 186329	● 187414
4	0.5	3.43	51	12.9	5	2.73	4	3.5	● 196202	● 186330	● 187415
5	0.5	4.43	51	15.9	5	3.73	4	4.5	● 196204	● 175199	● 187416
6	0.75	4.95	51	19.4	5	3.9	4	5.25	● 196206	● 186331	● 187417
8	1	5.95	75	26	6 ¹	4.55	5	7	● 196208	● 181233	● 187418
10	1	7.95	83	32	8 ¹	6.55	5	9	● 196178	● 186332	● 187419
10	1.25	7.95	83	33	8 ¹	6.2	5	8.8	● 196179	● 186333	● 187420
12	1.5	9.95	95	39	10 ¹	7.85	5	10.5	● 196181	● 186334	● 187421
14	1.5	10.95	120	51	12 ¹	8.85	5	12.5	● 196183	● 186335	● 187422
16	1.5	10.95	120	51	12 ¹	8.85	5	14.5	● 196185	● 186823	● 187423
18	1.5	13.95	135	63	14 ¹	11.85	6	16.5	● 196187	● 186336	● 187424
20	1.5	13.95	135	63	14 ¹	11.85	6	18.5	● 196195	● 186824	● 187425

¹ Tol. h6

GW

GW3019



R10

GW3019VS



R10

VS

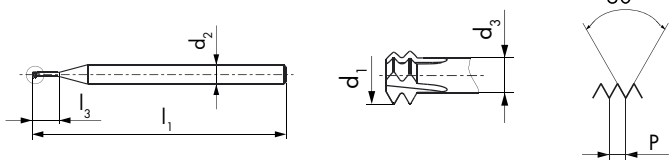

GW3019

GW3019VS



$\emptyset D_1$ MF	P mm	d_1 mm	l_1 mm	l_3 mm	d_2 h5 mm	d_3 mm			ID	ID
2	0.2	1.77	39	8.3	3	1.49	3	1.8	● 175254	● 175270
2	0.25	1.71	39	8.4	3	1.36	3	1.75	● 196242	● 186592
2.5	0.2	2.27	39	10.3	3	1.99	3	2.3	● 175255	● 175271
2.5	0.25	2.21	39	10.4	3	1.86	3	2.25	● 175256	● 175272
3	0.35	2.6	51	12.7	5	2.11	4	2.65	● 175257	● 175273
4	0.5	3.43	51	16.9	5	2.73	4	3.5	● 196247	● 186593
5	0.5	4.43	51	20.9	5	3.73	4	4.5	● 196248	● 171033
6	0.75	4.95	51	25.4	5	3.9	4	5.25	● 196249	● 186594
8	1	5.95	75	34	6 ¹	4.55	5	7	● 196250	● 186595
10	1	7.95	83	42	8 ¹	6.55	5	9	● 196251	● 186596
10	1.25	7.95	83	43	8 ¹	6.2	5	8.8	● 196252	● 186597
12	1.5	9.95	95	51	10 ¹	7.85	5	10.5	● 196253	● 186598
14	1.5	10.95	120	67	12 ¹	8.85	5	12.5	● 196254	● 186599
16	1.5	10.95	120	67	12 ¹	8.85	5	14.5	● 196255	● 186831
18	1.5	13.95	135	83	14 ¹	11.85	6	16.5	● 196256	● 186600
20	1.5	13.95	135	83	14	11.85	6	18.5	● 196257	● 186832

¹ Tol. h6

GW

GW3016



R10

GW3016VS



R10

VS

GW3016VX



R10

VX

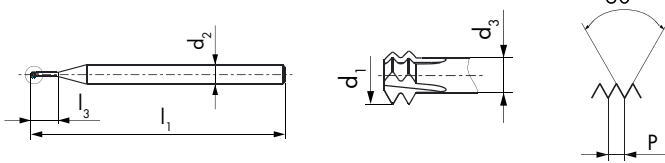

GW3016

GW3016VS

GW3016VX



Ø" D ₁ UNC	P TPI	d ₁ mm	l ₁ mm	l ₃ mm	d ₂ h5 mm	d ₃ mm		
2	56	1.66	39	6.1	3	1.02	3	1.75
3	48	1.91	39	7	3	1.17	3	2
4	40	2.11	39	8	3	1.22	3	2.25
5	40	2.44	51	9.1	5	1.55	4	2.55
6	32	2.59	51	10.2	5	1.48	4	2.75
8	32	3.25	51	11.9	5	2.14	4	3.4
10	24	3.6	51	14	5	2.12	4	3.8
12	24	4.27	51	15.7	5	2.79	4	4.4
1/4	20	4.89	51	18.2	5	3.11	4	5.1
5/16	18	5.95	63	23	6 ¹	3.97	5	6.5
3/8	16	7.1	67	27	8 ¹	4.87	5	8
7/16	14	7.95	67	32	8 ¹	5.41	5	9.3
1/2	13	9.95	76	36	10 ¹	7.21	5	10.8

ID

ID

ID

● 167472

● 167500

● 187298

● 196158

● 186236

● 187299

● 167473

● 167501

● 187300

● 196159

● 186237

● 187301

● 167474

● 167502

● 187302

● 167475

● 167503

● 187303

● 173983

● 173986

● 187304

● 196160

● 186238

● 187305

● 167476

● 167504

● 187306

● 175232

● 175246

● 187307

● 175233

● 173546

● 187308

● 196161

● 186239

● 187309

● 175234

● 175247

● 187310

¹ Tol. h6

GW

GW3017



GW3017VS



GW3017VX

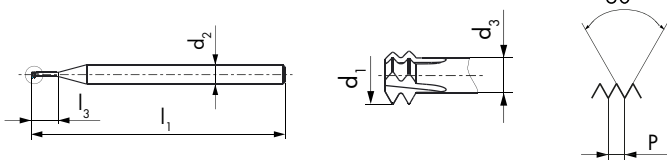

GW3017

GW3017VS

GW3017VX

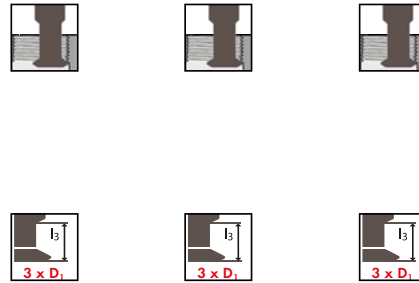

Ø" D ₁ UNC	P TPI	d ₁ mm	l ₁ mm	l ₃ mm	d ₂ h5 mm	d ₃ mm			ID	ID	ID
2	56	1.66	39	7.2	3	1.02	3	1.75	● 196219	● 186365	● 187426
3	48	1.91	39	8.3	3	1.17	3	2	● 196221	● 186366	● 187427
4	40	2.11	39	9.4	3	1.22	3	2.25	● 196222	● 186367	● 187428
5	40	2.44	51	10.7	5	1.55	4	2.55	● 196224	● 186368	● 187429
6	32	2.59	51	12	5	1.48	4	2.75	● 196225	● 186369	● 187430
8	32	3.25	51	14	5	2.14	4	3.4	● 196227	● 186370	● 187431
10	24	3.6	51	16.4	5	2.12	4	3.8	● 196217	● 186371	● 187432
12	24	4.27	51	18.4	5	2.79	4	4.4	● 196218	● 186372	● 187433
1/4	20	4.89	51	21.4	5	3.11	4	5.1	● 196216	● 186373	● 187434
5/16	18	5.95	75	27	6 ¹	3.97	5	6.5	● 196223	● 186374	● 187435
3/8	16	7.1	83	32	8 ¹	4.87	5	8	● 196220	● 186375	● 187436
7/16	14	7.95	83	37	8 ¹	5.41	5	9.3	● 196226	● 186376	● 187437
1/2	13	9.95	95	42	10 ¹	7.21	5	10.8	● 196215	● 186377	● 187438

¹ Tol. h6

GW

GW3019



R10

GW3019VS



R10

VS

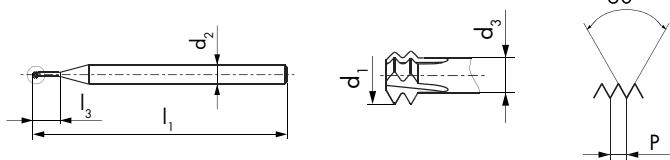

GW3019

GW3019VS



Ø" D ₁ UNC	P TPI	d ₁ mm	l ₁ mm	l ₃ mm	d ₂ h5 mm	d ₃ mm			ID	ID
2	56	1.66	39	9.4	3	1.02	3	1.75	● 167479	● 167507
3	48	1.91	39	10.8	3	1.17	3	2	● 196258	● 186601
4	40	2.11	39	12.2	3	1.22	3	2.25	● 167480	● 167508
5	40	2.44	51	13.9	5	1.55	4	2.55	● 196259	● 186602
6	32	2.59	51	15.5	5	1.48	4	2.75	● 167481	● 167509
8	32	3.25	51	18.1	5	2.14	4	3.4	● 167482	● 167510
10	24	3.6	51	21.3	5	2.12	4	3.8	● 173982	● 173979
12	24	4.27	51	23.9	5	2.79	4	4.4	● 196260	● 186603
1/4	20	4.89	51	27.7	5	3.11	4	5.1	● 167483	● 167511
5/16	18	5.95	75	35	6 ¹	3.97	5	6.5	● 175261	● 175277
3/8	16	7.1	83	41	8 ¹	4.87	5	8	● 175262	● 175278
7/16	14	7.95	83	48	8 ¹	5.41	5	9.3	● 196261	● 186604
1/2	13	9.95	95	55	10 ¹	7.21	5	10.8	● 175263	● 175279

¹ Tol. h6

GW

GW3016



GW3016VS



GW3016VX

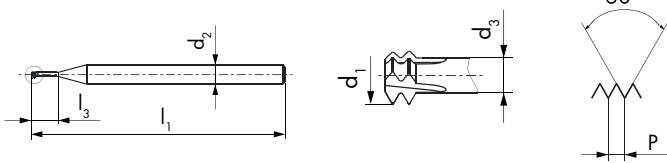

GW3016

GW3016VS

GW3016VX



Ø" D ₁ UNF	P TPI	d ₁ mm	l ₁ mm	l ₂ mm	d ₂ h5 mm	d ₃ mm			ID	ID	ID
0	80	1.15	39	4.3	3	0.71	3	1.2	● 175235	● 175248	● 187311
1	72	1.44	39	5.1	3	0.95	3	1.5	● 175236	● 175249	● 187312
2	64	1.73	39	6	3	1.17	3	1.8	● 196162	● 186248	● 187313
4	48	2.23	39	7.9	3	1.49	3	2.35	● 175237	● 175250	● 187314
5	44	2.51	51	9	5	1.7	4	2.6	● 196163	● 186249	● 187315
6	40	2.77	51	10	5	1.88	4	2.9	● 196164	● 186250	● 187316
8	36	3.35	51	11.7	5	2.36	4	3.5	● 175238	● 175251	● 187317
10	32	3.91	51	13.5	5	2.8	4	4.05	● 167477	● 167505	● 187318
12	28	4.44	51	15.4	5	3.17	4	4.6	● 196165	● 186251	● 187319
1/4	28	4.95	51	17.6	5	3.68	4	5.5	● 167478	● 167506	● 187320
5/16	24	5.95	63	22	6 ¹	4.47	5	6.9	● 175239	● 175252	● 187321
3/8	24	7.1	67	26	8 ¹	5.62	5	8.5	● 175240	● 175253	● 187322
7/16	20	7.95	67	31	8 ¹	6.17	5	9.8	● 196166	● 186252	● 187323
1/2	20	9.95	76	35	10 ¹	8.17	5	11.4	● 196167	● 186253	● 187324

¹ Tol. h6

GW

GW3017



GW3017VS



GW3017VX

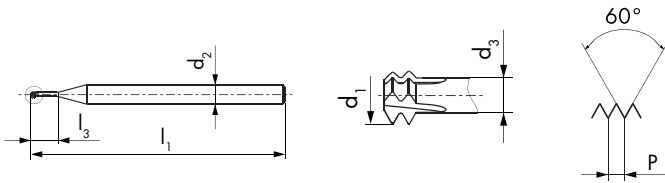

GW3017

GW3017VS

GW3017VX

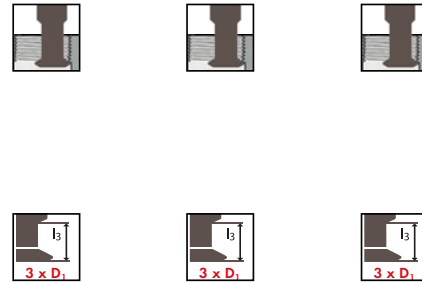

Ø" D ₁ UNF	P TPI	d ₁ mm	l ₁ mm	l ₃ mm	d ₂ h5 mm	d ₃ mm			ID	ID	ID
0	80	1.15	39	5	3	0.71	3	1.2	● 196228	● 186404	● 187439
1	72	1.44	39	6.1	3	0.95	3	1.5	● 196233	● 186405	● 187440
2	64	1.73	39	7.1	3	1.17	3	1.8	● 196234	● 186406	● 187441
4	48	2.23	39	9.3	3	1.49	3	2.35	● 196236	● 186407	● 187442
5	44	2.51	51	10.6	5	1.7	4	2.6	● 196238	● 186408	● 187443
6	40	2.77	51	11.7	5	1.88	4	2.9	● 196239	● 186409	● 187444
8	36	3.35	51	13.8	5	2.36	4	3.5	● 196241	● 186410	● 187445
10	32	3.91	51	15.9	5	2.8	4	4.05	● 196231	● 184633	● 187446
12	28	4.44	51	18.1	5	3.17	4	4.6	● 196232	● 186411	● 187447
1/4	28	4.95	51	20.7	5	3.68	4	5.5	● 196230	● 186412	● 187448
5/16	24	5.95	75	26	6 ¹	4.47	5	6.9	● 196237	● 186413	● 187449
3/8	24	7.1	83	31	8 ¹	5.62	5	8.5	● 196235	● 186414	● 187450
7/16	20	7.95	83	36	8 ¹	6.17	5	9.8	● 196240	● 186415	● 187451
1/2	20	9.95	95	41	10 ¹	8.17	5	11.4	● 196229	● 186416	● 187452

¹ Tol. h6

GW

GW3019



GW3019VS

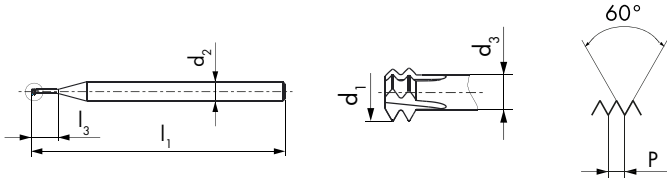

GW3019

GW3019VS



Ø" D ₁ UNF	P TPI	d ₁ mm	l ₁ mm	l ₂ mm	d ₂ h5 mm	d ₃ mm			ID	ID
0	80	1.15	39	6.6	3	0.71	3	1.2	● 175264	● 175280
1	72	1.44	39	7.9	3	0.95	3	1.5	● 175265	● 175281
2	64	1.73	39	9.3	3	1.17	3	1.8	● 196262	● 186605
4	48	2.23	39	12.1	3	1.49	3	2.35	● 175266	● 172376
5	44	2.51	51	13.8	5	1.7	4	2.6	● 196263	● 169815
6	40	2.77	51	15.2	5	1.88	4	2.9	● 196264	● 186606
8	36	3.35	51	18	5	2.36	4	3.5	● 175267	● 175282
10	32	3.91	51	20.8	5	2.8	4	4.05	● 167484	● 167512
12	28	4.44	51	23.6	5	3.17	4	4.6	● 196265	● 186607
1/4	28	4.95	51	27.1	5	3.68	4	5.5	● 167485	● 167513
5/16	24	5.95	75	34	6 ¹	4.47	5	6.9	● 175268	● 175283
3/8	24	7.1	83	40	8 ¹	5.62	5	8.5	● 175269	● 175284
7/16	20	7.95	83	47	8 ¹	6.17	5	9.8	● 196266	● 186608
1/2	20	9.95	95	54	10 ¹	8.17	5	11.4	● 196267	● 186609

¹ Tol. h6

GW

GW3016



GW3016VS



GW3016VX



GW3016

GW3016VS

GW3016VX

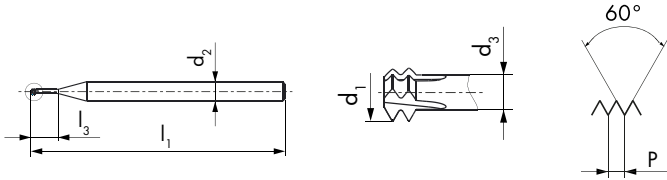
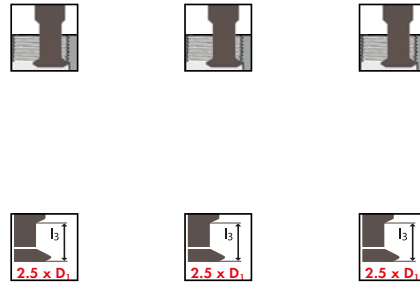

Ø D ₁ S	P mm	d ₁ mm	l ₁ mm	l ₃ mm	d ₂ h5 mm	d ₃ mm		
0.8	0.2	0.57	39	2.3	3	0.29	3	0.66 ¹
0.9	0.225	0.64	39	2.6	3	0.33	3	0.74 ¹
1	0.25	0.71	39	2.9	3	0.36	3	0.82 ¹
1.2	0.25	0.91	39	3.4	3	0.56	3	1.02 ¹
1.4	0.3	1.06	39	3.9	3	0.64	3	1.18 ¹

ID	ID	ID
● 196168	● 194287	● 194305
● 196169	● 182875	● 194306
● 180683	● 168667	● 194307
● 196170	● 194288	● 194308
● 196171	● 194289	● 194309

¹ 4H5H → 4H6H = +0.02mm

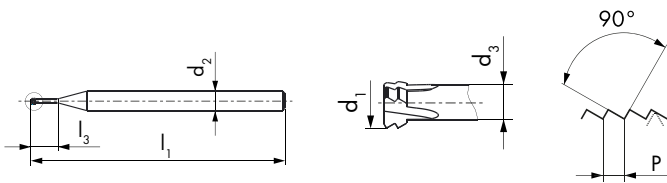

Ø D ₁ SL	P mm	d ₁ mm	l ₁ mm	l ₃ mm	d ₂ h5 mm	d ₃ mm		
0.8	0.15	0.63	39	2.3	3	0.42	3	0.74
0.9	0.175	0.7	39	2.6	3	0.46	3	0.83
1	0.2	0.77	39	2.9	3	0.49	3	0.92
1.2	0.2	0.97	39	3.4	3	0.69	3	1.11
1.4	0.25	1.11	39	3.9	3	0.76	3	1.3

ID	ID
● 600028	● 600034
● 600029	● 600035
● 600030	● 600036
● 600031	● 600037
● 600032	● 600038

GW										GW3017	GW3017VS	GW3017VX		
Ø D ₁ S	P mm	d ₁ mm	l ₁ mm	l ₃ mm	d ₂ h5 mm	d ₃ mm				ID	ID	ID		
0.8	0.2	0.57	39	2.7	3	0.29	3				● 196210	● 194291	● 194312	
0.9	0.225	0.64	39	3	3	0.33	3				● 196211	● 194292	● 194313	
1	0.25	0.71	39	3.4	3	0.36	3				● 196214	● 194293	● 194314	
1.2	0.25	0.91	39	4	3	0.56	3				● 196212	● 194294	● 194315	
1.4	0.3	1.06	39	4.6	3	0.64	3				● 196213	● 194295	● 194316	

¹ 4H5H → 4H6H = +0.02mm

GW

GW3019





GW3019VS

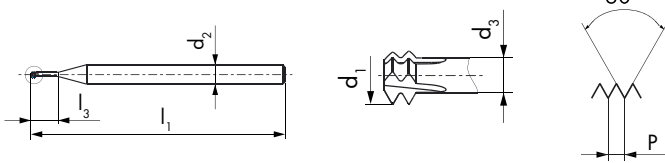

GW3019

GW3019VS



$\frac{\emptyset D_1}{S}$	P mm	d_1 mm	l_1 mm	l_3 mm	d_2 h5 mm	d_3 mm			ID	ID
0.8	0.2	0.57	39	3.5	3	0.29	3	0.66 ¹	● 196270	● 194298
0.9	0.225	0.64	39	3.9	3	0.33	3	0.74 ¹	● 196271	● 194299
1	0.25	0.71	39	4.4	3	0.36	3	0.82 ¹	● 196274	● 194300
1.2	0.25	0.91	39	5.2	3	0.56	3	1.02 ¹	● 196272	● 194301
1.4	0.3	1.06	39	6	3	0.64	3	1.18 ¹	● 196273	● 194302

¹  4H5H → 4H6H = +0.02mm

GWi

GWi3066VS



GWi3066VX

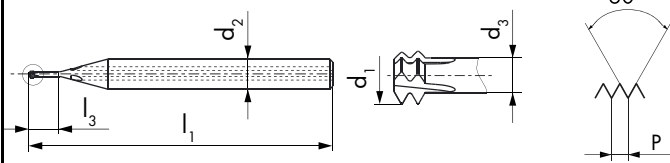

GWi3066VS

GWi3066VX



Ø D ₁ M	P mm	d ₁ mm	l ₁ mm	l ₃ mm	d ₂ h6 mm	d ₃ mm			ID	ID
0.8	0.2	0.57	40	2.3	3	0.29	3	0.66	● 186029	● 187325
0.9	0.225	0.64	40	2.6	3	0.33	3	0.74	● 186030	● 187326
1	0.25	0.71	40	2.9	3	0.36	3	0.75	● 186031	● 187327
1.2	0.25	0.91	40	3.4	3	0.56	3	0.95	● 186032	● 187328
1.4	0.3	1.06	40	3.9	4	0.64	3	1.1	● 186033	● 187329
1.6	0.35	1.2	40	4.5	4	0.71	3	1.25	● 186034	● 187330
1.8	0.35	1.4	40	5	4	0.91	3	1.45	● 186035	● 187331
2	0.4	1.54	40	5.6	4	0.98	3	1.6	● 186036	● 187332
2.3	0.4	1.84	40	6.3	4	1.28	3	1.9	● 194324	● 194334
2.5	0.45	1.98	40	6.9	4	1.35	3	2.05	● 186037	● 187333
2.6	0.45	2.08	40	7.1	4	1.45	3	2.15	● 194325	● 194335
3	0.5	2.43	51	8.4	5	1.73	4	2.5	● 186038	● 187334
3.5	0.6	2.81	51	9.9	6	1.97	4	2.9	● 186039	● 187335
4	0.7	3.2	51	11.3	6	2.22	4	3.3	● 186040	● 187336
5	0.8	4.08	51	14	8	2.96	4	4.2	● 186041	● 187337
6	1	4.85	51	16.8	8	3.45	4	5	● 186042	● 187338
8	1.25	5.95	75	23	6	4.2	5	6.8	● 186043	● 187339
10	1.5	7.95	83	28	8	5.85	5	8.5	● 186044	● 187340
12	1.75	9.95	95	34	10	7.5	5	10.2	● 186045	● 187341
14	2	10.95	120	44	12	8.15	5	12	● 186046	● 187342
16	2	10.95	120	44	12	8.15	5	14	● 186817	● 187343
18	2.5	13.95	135	55	14	10.45	6	15.5	● 186047	● 187344
20	2.5	13.95	135	55	14	10.45	6	17.5	● 186818	● 187345

GWi

GWi3067VS



VS

GWi3067VX



VX

GWi3067VS

GWi3067VX

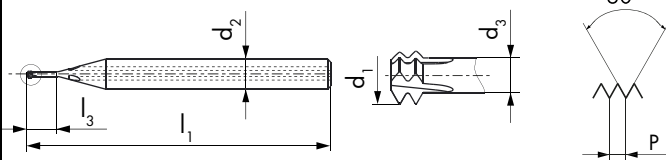

Ø D ₁ M	P mm	d ₁ mm	l ₁ mm	l ₃ mm	d ₂ h6 mm	d ₃ mm		
1.4	0.3	1.06	40	4.6	4	0.64	3	1.1
1.6	0.35	1.2	40	5.3	4	0.71	3	1.25
1.8	0.35	1.4	40	5.9	4	0.91	3	1.45
2	0.4	1.54	40	6.6	4	0.98	3	1.6
2.3	0.4	1.84	40	7.5	4	1.28	3	1.9
2.5	0.45	1.98	40	8.1	4	1.35	3	2.05
2.6	0.45	2.08	40	8.4	4	1.45	3	2.15
3	0.5	2.43	51	9.9	5	1.73	4	2.5
3.5	0.6	2.81	51	11.6	6	1.97	4	2.9
4	0.7	3.2	51	13.3	6	2.22	4	3.3
5	0.8	4.08	51	16.5	8	2.96	4	4.2
6	1	4.85	51	19.8	8	3.45	4	5
8	1.25	5.95	75	27	6	4.2	5	6.8
10	1.5	7.95	83	33	8	5.85	5	8.5
12	1.75	9.95	95	40	10	7.5	5	10.2
14	2	10.95	120	52	12	8.15	5	12
16	2	10.95	120	52	12	8.15	5	14
18	2.5	13.95	135	65	14	10.45	6	15.5
20	2.5	13.95	135	65	14	10.45	6	17.5

ID

ID

● 186443	● 187453
● 186444	● 187454
● 186445	● 187455
● 186446	● 187456
● 194327	● 194337
● 186447	● 187457
● 194328	● 194338
● 186448	● 187458
● 186449	● 187459
● 186450	● 187460
● 186451	● 187461
● 186452	● 187462
● 186453	● 187463
● 186454	● 187464
● 186455	● 187465
● 186456	● 187466
● 186825	● 187467
● 186457	● 187468
● 186826	● 187469

GWi

GWi3067VS



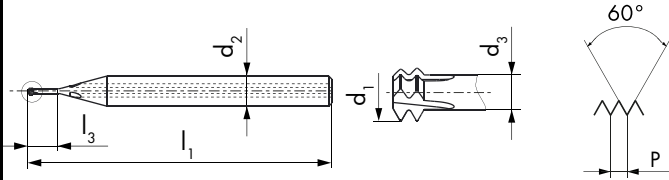

GWi3067VX

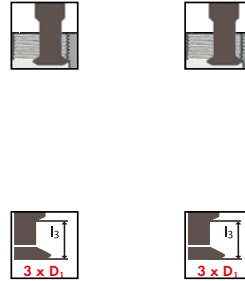

GWi3067VS

GWi3067VX



$\emptyset D_1$ MJ	P mm	d_1 mm	l_1 mm	l_3 mm	d_2 h6 mm	d_3 mm			ID	ID
3	0.5	2.17	51	9.9	5	1.47	4	2.55	● 188820	● 188843
4	0.7	2.84	51	13.3	6	1.86	4	3.4	● 188821	● 188844
5	0.8	3.67	51	16.5	8	2.55	4	4.3	● 188822	● 188845
6	1	4.34	51	19.8	8	2.94	4	5.1	● 188823	● 188846
8	1.25	5.95	75	27	6	4.2	5	6.9	● 188824	● 188847
10	1.5	7.95	83	33	8	5.85	5	8.6	● 188825	● 188848
12	1.75	9.95	95	40	10	7.5	5	10.4	● 188826	● 188849



GWi

GWi3069VS

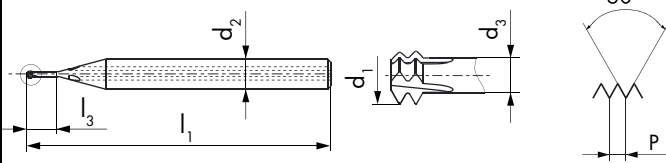

GWi3069VS



Ø D ₁ M	P mm	d ₁ mm	l ₁ mm	l ₃ mm	d ₂ h6 mm	d ₃ mm			ID
3	0.5	2.43	51	12.9	5	1.73	4	2.5	● 186610
3.5	0.6	2.81	51	15.1	6	1.97	4	2.9	● 186611
4	0.7	3.2	51	17.3	6	2.22	4	3.3	● 186612
5	0.8	4.08	51	21.5	8	2.96	4	4.2	● 186613
6	1	4.85	51	25.8	8	3.45	4	5	● 186614
8	1.25	5.95	75	35	6	4.2	5	6.8	● 186615
10	1.5	7.95	83	43	8	5.85	5	8.5	● 186616
12	1.75	9.95	95	52	10	7.5	5	10.2	● 186617
14	2	10.95	120	68	12	8.15	5	12	● 186618
16	2	10.95	120	68	12	8.15	5	14	● 186833
18	2.5	13.95	135	85	14	10.45	6	15.5	● 186619
20	2.5	13.95	135	85	14	10.45	6	17.5	● 186834

GWi

GWi3066VS



VS

GWi3066VX



VX

GWi3066VS

GWi3066VX

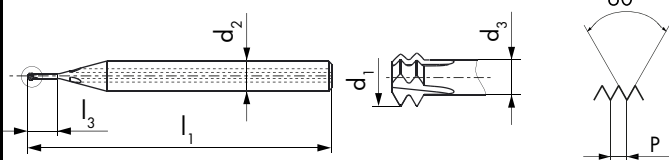

Ø D ₁ MF	P mm	d ₁ mm	l ₁ mm	l ₃ mm	d ₂ h6 mm	d ₃ mm		
2	0.2	1.77	40	5.3	4	1.49	3	1.8
2	0.25	1.71	40	5.4	4	1.36	3	1.75
2.5	0.2	2.27	40	6.6	4	1.99	3	2.3
2.5	0.25	2.21	40	6.6	4	1.86	3	2.25
3	0.35	2.6	51	8.2	5	2.11	4	2.65
4	0.5	3.43	51	10.9	6	2.73	4	3.5
5	0.5	4.43	51	13.4	8	3.73	4	4.5
6	0.75	4.95	51	16.4	8	3.9	4	5.25
8	1	5.95	75	22	6	4.55	5	7
10	1	7.95	83	27	8	6.55	5	9
10	1.25	7.95	83	28	8	6.2	5	8.8
12	1.5	9.95	95	33	10	7.85	5	10.5
14	1.5	10.95	120	43	12	8.85	5	12.5
16	1.5	10.95	120	43	12	8.85	5	14.5
18	1.5	13.95	135	53	14	11.85	6	16.5
20	1.5	13.95	135	53	14	11.85	6	18.5

ID

ID

● 186086	● 187346
● 186087	● 187347
● 186088	● 187348
● 186089	● 187349
● 186090	● 187350
● 186091	● 187351
● 186092	● 187352
● 186093	● 187353
● 186094	● 187354
● 186095	● 187355
● 186096	● 187356
● 186097	● 187357
● 186098	● 187358
● 186819	● 187359
● 186099	● 187360
● 186820	● 187361

GWi

GWi3067VS



GWi3067VX



GWi3067VS

GWi3067VX

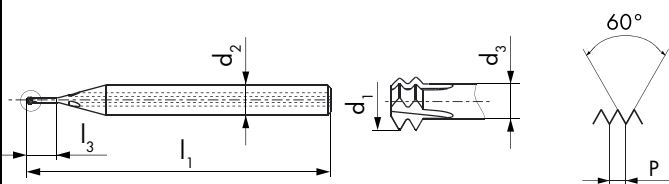

Ø D ₁ MF	P mm	d ₁ mm	l ₁ mm	l ₃ mm	d ₂ h6 mm	d ₃ mm			ID	ID
2	0.2	1.77	40	6.3	4	1.49	3	1.8	● 186488	● 187470
2	0.25	1.71	40	6.4	4	1.36	3	1.75	● 186489	● 187471
2.5	0.2	2.27	40	7.8	4	1.99	3	2.3	● 186490	● 187472
2.5	0.25	2.21	40	7.9	4	1.86	3	2.25	● 186491	● 187473
3	0.35	2.6	51	9.7	5	2.11	4	2.65	● 186492	● 187474
4	0.5	3.43	51	12.9	6	2.73	4	3.5	● 186493	● 187475
5	0.5	4.43	51	15.9	8	3.73	4	4.5	● 186494	● 187476
6	0.75	4.95	51	19.4	8	3.9	4	5.25	● 186495	● 187477
8	1	5.95	75	26	6	4.55	5	7	● 186496	● 187478
10	1	7.95	83	32	8	6.55	5	9	● 186497	● 187479
10	1.25	7.95	83	33	8	6.2	5	8.8	● 186498	● 187480
12	1.5	9.95	95	39	10	7.85	5	10.5	● 186499	● 187481
14	1.5	10.95	120	51	12	8.85	5	12.5	● 186500	● 187482
16	1.5	10.95	120	51	12	8.85	5	14.5	● 186827	● 187483
18	1.5	13.95	135	63	14	11.85	6	16.5	● 186501	● 187484
20	1.5	13.95	135	63	14	11.85	6	18.5	● 186828	● 187485

GWi

GWi3067VS



GWi3067VX



GWi3067VS

GWi3067VX

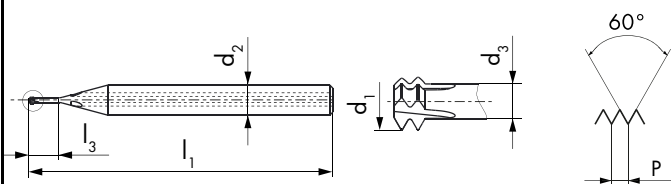

Ø D ₁ MJF	P mm	d ₁ mm	l ₁ mm	l ₃ mm	d ₂ h6 mm	d ₃ mm		
6	0.75	4.76	51	19.4	8	3.71	4	5.35
8	1	5.95	75	26	6	4.55	5	7.1
10	1.25	7.95	83	33	8	6.2	5	8.9
12	1.5	9.95	95	39	10	7.85	5	10.6

ID

ID

● 188827

● 188850

● 188828

● 188851

● 188829

● 188852

● 188830

● 188853

GWi

GWi3069VS



GWi3069VS

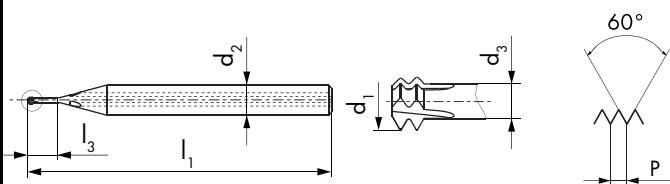

Ø D ₁ MF	P mm	d ₁ mm	l ₁ mm	l ₃ mm	d ₂ h6 mm	d ₃ mm		
3	0.35	2.6	51	12.7	5	2.11	4	2.65
4	0.5	3.43	51	16.9	6	2.73	4	3.5
5	0.5	4.43	51	20.9	8	3.73	4	4.5
6	0.75	4.95	51	25.4	8	3.9	4	5.25
8	1	5.95	75	34	6	4.55	5	7
10	1	7.95	83	42	8	6.55	5	9
10	1.25	7.95	83	43	8	6.2	5	8.8
12	1.5	9.95	95	51	10	7.85	5	10.5
14	1.5	10.95	120	67	12	8.85	5	12.5
16	1.5	10.95	120	67	12	8.85	5	14.5
18	1.5	13.95	135	83	14	11.85	6	16.5
20	1.5	13.95	135	83	14	11.85	6	18.5

ID

- 186620
- 186621
- 186622
- 186623
- 186624
- 186625
- 186626
- 186627
- 186628
- 186835
- 186629
- 186836

GWi

GWi3066VS



VS

GWi3066VX



VX

GWi3066VS

GWi3066VX

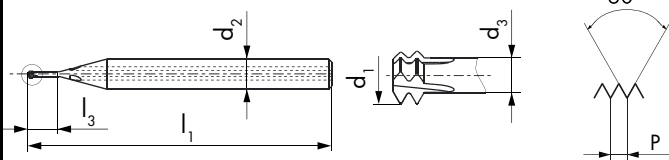

Ø" D ₁ UNC	P TPI	d ₁ mm	l ₁ mm	l ₃ mm	d ₂ h6 mm	d ₃ mm		
2	56	1.66	40	6.1	4	1.02	3	1.75
3	48	1.91	40	7	4	1.17	3	2
4	40	2.11	51	8	5	1.22	3	2.25
5	40	2.44	51	9.1	5	1.55	4	2.55
6	32	2.59	51	10.2	6	1.48	4	2.75
8	32	3.25	51	11.9	6	2.14	4	3.4
10	24	3.6	51	14	8	2.12	4	3.8
12	24	4.27	51	15.7	8	2.79	4	4.4
1/4	20	4.89	51	18.2	8	3.11	4	5.1
5/16	18	5.95	75	23	6	3.97	5	6.5
3/8	16	7.1	83	27	8	4.87	5	8
7/16	14	7.95	83	32	8	5.41	5	9.3
1/2	13	9.95	95	36	10	7.21	5	10.8

ID

ID

● 186128	● 187362
● 186129	● 187363
● 186130	● 187364
● 186131	● 187365
● 186132	● 187366
● 186133	● 187367
● 186134	● 187368
● 186135	● 187369
● 186136	● 187370
● 186137	● 187371
● 186138	● 187372
● 186139	● 187373
● 186140	● 187374

GWi

GWi3067VS



GWi3067VX



GWi3067VS

GWi3067VX

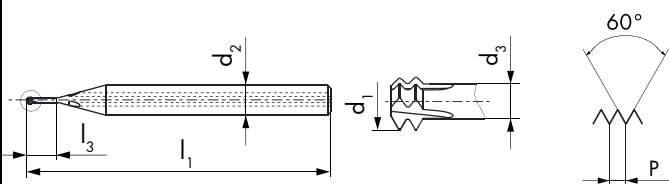

Ø" D ₁ UNC	P TPI	d ₁ mm	l ₁ mm	l ₃ mm	d ₂ h6 mm	d ₃ mm		
4	40	2.11	51	9.4	5	1.22	3	2.25
5	40	2.44	51	10.7	5	1.55	4	2.55
6	32	2.59	51	12	6	1.48	4	2.75
8	32	3.25	51	14	6	2.14	4	3.4
10	24	3.6	51	16.4	8	2.12	4	3.8
12	24	4.27	51	18.4	8	2.79	4	4.4
1/4	20	4.89	51	21.4	8	3.11	4	5.1
5/16	18	5.95	75	27	6	3.97	5	6.5
3/8	16	7.1	83	32	8	4.87	5	8
7/16	14	7.95	83	37	8	5.41	5	9.3
1/2	13	9.95	95	42	10	7.21	5	10.8

ID

ID

● 186526	● 187486
● 186527	● 187487
● 186528	● 187488
● 186529	● 187489
● 186530	● 187490
● 186531	● 187491
● 186532	● 187492
● 186533	● 187493
● 186534	● 187494
● 186535	● 187495
● 186536	● 187496

GWi

GWi3067VS



GWi3067VX



GWi3067VS

GWi3067VX

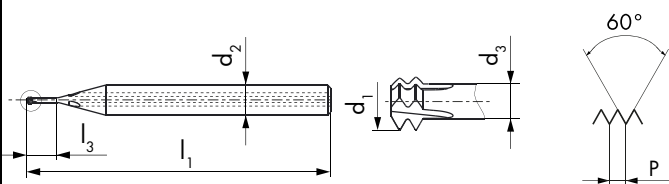

Ø" D ₁ UNJC	P TPI	d ₁ mm	l ₁ mm	l ₃ mm	d ₂ h6 mm	d ₃ mm			ID	ID
6	32	2.59	51	12	6	1.48	4	2.8	● 188831	● 188854
10	24	3.6	51	16.4	8	2.12	4	3.9	● 188832	● 188855
1/4	20	4.89	51	21.4	8	3.11	4	5.2	● 188833	● 188856
5/16	18	5.95	75	27	6	3.97	5	6.7	● 188834	● 188857
3/8	16	7.1	83	32	8	4.87	5	8.1	● 188835	● 188858
1/2	13	9.95	95	42	10	7.21	5	10.9	● 188836	● 188859

GWi

GWi3069VS



GWi3069VS

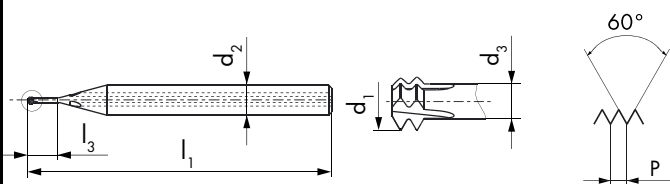

Ø" D ₁ UNC	P TPI	d ₁ mm	l ₁ mm	l ₃ mm	d ₂ h6 mm	d ₃ mm			ID
6	32	2.59	51	15.5	6	1.48	4	2.75	● 186630
8	32	3.25	51	18.1	6	2.14	4	3.4	● 186631
10	24	3.6	51	21.3	8	2.12	4	3.8	● 186632
12	24	4.27	51	23.9	8	2.79	4	4.4	● 186633
1/4	20	4.89	51	27.7	8	3.11	4	5.1	● 186634
5/16	18	5.95	75	35	6	3.97	5	6.5	● 186635
3/8	16	7.1	83	41	8	4.87	5	8	● 186636
7/16	14	7.95	83	48	8	5.41	5	9.3	● 186637
1/2	13	9.95	95	55	10	7.21	5	10.8	● 186638

GWi

GWi3066VS



VS

GWi3066VX





VX

GWi3066VS

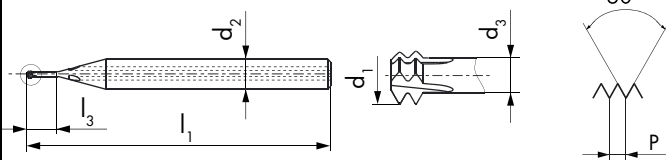
GWi3066VX



$\emptyset'' D_1$ UNF	P TPI	d_1 mm	l_1 mm	l_3 mm	d_2 h6 mm	d_3 mm		
0	80	1.15	40	4.3	4	0.71	3	1.2
1	72	1.44	40	5.1	4	0.95	3	1.5
2	64	1.73	40	6	4	1.17	3	1.8
4	48	2.23	51	7.9	5	1.49	3	2.35
5	44	2.51	51	9	5	1.7	4	2.6
6	40	2.77	51	10	6	1.88	4	2.9
8	36	3.35	51	11.7	6	2.36	4	3.5
10	32	3.91	51	13.5	8	2.8	4	4.05
12	28	4.44	51	15.4	8	3.17	4	4.6
1/4	28	4.95	51	17.6	8	3.68	4	5.5
5/16	24	5.95	75	22	6	4.47	5	6.9
3/8	24	7.1	83	26	8	5.62	5	8.5
7/16	20	7.95	83	31	8	6.17	5	9.8
1/2	20	9.95	95	35	10	8.17	5	11.4

ID

ID

● 186167	● 187375
● 186168	● 187376
● 186169	● 187377
● 186170	● 187378
● 186171	● 187379
● 186172	● 187380
● 186173	● 187381
● 186174	● 187382
● 186175	● 187383
● 186176	● 187384
● 186177	● 187385
● 186178	● 187386
● 186179	● 187387
● 186180	● 187388

GWi

GWi3067VS



VS

GWi3067VX



VX

GWi3067VS

GWi3067VX

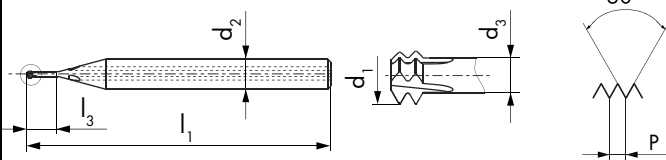

Ø" D ₁ UNF	P TPI	d ₁ mm	l ₁ mm	l ₃ mm	d ₂ h6 mm	d ₃ mm		
4	48	2.23	51	9.3	5	1.49	3	2.35
5	44	2.51	51	10.6	5	1.7	4	2.6
6	40	2.77	51	11.7	6	1.88	4	2.9
8	36	3.35	51	13.8	6	2.36	4	3.5
10	32	3.91	51	16	8	2.8	4	4.05
12	28	4.44	51	18.1	8	3.17	4	4.6
1/4	28	4.95	51	20.7	8	3.68	4	5.5
5/16	24	5.95	75	26	6	4.47	5	6.9
3/8	24	7.1	83	31	8	5.62	5	8.5
7/16	20	7.95	83	36	8	6.17	5	9.8
1/2	20	9.95	95	41	10	8.17	5	11.4

ID

ID

● 186559	● 187497
● 186560	● 187498
● 186561	● 187499
● 186562	● 187500
● 186563	● 187501
● 186564	● 187502
● 186565	● 187503
● 186566	● 187504
● 186567	● 187505
● 186568	● 187506
● 186569	● 187507

GWi

GWi3067VS



GWi3067VX



GWi3067VS

GWi3067VX

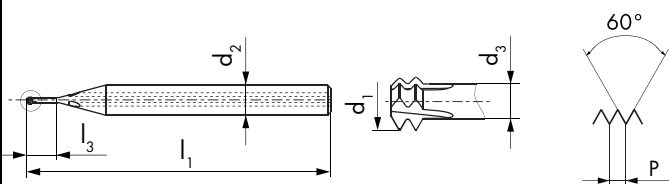

Ø" D ₁ UNJF	P TPI	d ₁ mm	l ₁ mm	l ₃ mm	d ₂ h6 mm	d ₃ mm		
8	36	2.99	51	13.8	6	2	4	3.55
10	32	3.51	51	16	8	2.4	4	4.1
1/4	28	4.84	51	20.7	8	3.57	4	5.55
5/16	24	5.95	75	26	6	4.47	5	7
3/8	24	7.1	83	31	8	5.62	5	8.6
1/2	20	9.95	95	41	10	8.17	5	11.55

ID

ID

● 188837

● 188860

● 188838

● 188861

● 188839

● 188862

● 188840

● 188863

● 188841

● 188864

● 188842

● 188865

GWi

GWi3069VS



GWi3069VS

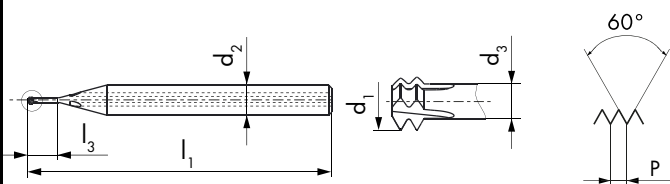

Ø" D ₁ UNF	P TPI	d ₁ mm	l ₁ mm	l ₃ mm	d ₂ h6 mm	d ₃ mm			ID
6	40	2.77	51	15.2	6	1.88	4	2.9	● 186639
8	36	3.35	51	18	6	2.36	4	3.5	● 186640
10	32	3.91	51	20.8	8	2.8	4	4.05	● 186641
12	28	4.44	51	23.6	8	3.17	4	4.6	● 186642
1/4	28	4.95	51	27.1	8	3.68	4	5.5	● 186643
5/16	24	5.95	75	34	6	4.47	5	6.9	● 186644
3/8	24	7.1	83	40	8	5.62	5	8.5	● 186645
7/16	20	7.95	83	47	8	6.17	5	9.8	● 186646
1/2	20	9.95	95	54	10	8.17	5	11.4	● 186647

GWi

GWi3066VS



VS

GWi3066VX



VX

GWi3067VS



VS

GWi3067VX



VX

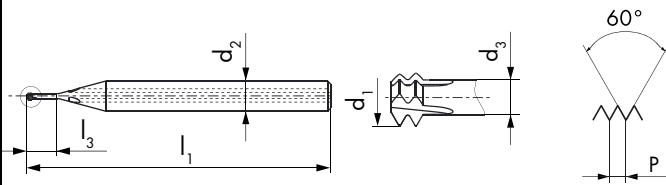

GWi3066VS

GWi3066VX

GWi3067VS

GWi3067VX



$\frac{\emptyset D_1}{S}$	P mm	d_1 mm	l_1 mm	l_3 mm	d_2 h6 mm	d_3 mm		
0.8	0.2	0.57	40	2.3	3	0.29	3	0.66 ¹
0.9	0.225	0.64	40	2.6	3	0.33	3	0.74 ¹
1	0.25	0.71	40	2.9	3	0.36	3	0.82 ¹
1.2	0.25	0.91	40	3.4	3	0.56	3	1.02 ¹
1.4	0.3	1.06	40	3.9	4	0.64	3	1.18 ¹

ID

ID

● 194319

● 194329

● 194320

● 194330

● 194321

● 194331

● 194322

● 194332

● 194323

● 194333

¹ 4H5H → 4H6H = +0.02mm

$\frac{\emptyset D_1}{S}$	P mm	d_1 mm	l_1 mm	l_3 mm	d_2 h6 mm	d_3 mm		
1.4	0.3	1.06	40	4.6	4	0.64	3	1.18 ¹

ID

ID

● 194326

● 194336

¹ 4H5H → 4H6H = +0.02mm

GWi

GWi5066VS



GWi5067VS

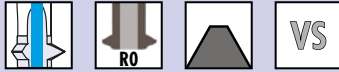

GWi5066VS

GWi5067VS



LH-rot.



LH-rot.

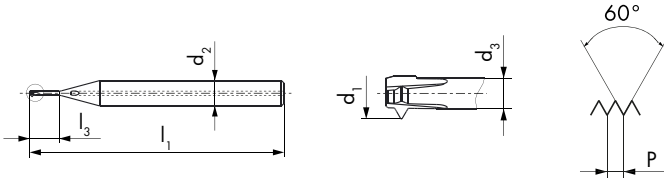

$\emptyset D_1$ M	P mm	d_1 mm	l_1 mm	l_3 mm	d_2 h6 mm	d_3 mm			ID
0.8	0.2	0.55	40	2.3	3	0.27	1	0.58 ¹	● 189165
0.9	0.225	0.62	40	2.6	3	0.31	1	0.65 ¹	● 189166
1	0.25	0.66	40	2.9	3	0.31	1	0.7 ¹	● 189167
1.2	0.25	0.86	40	3.4	3	0.51	1	0.9 ¹	● 189168
1.4	0.3	1.03	40	4	4	0.61	1	1.05 ¹	● 189169
1.6	0.35	1.16	40	4.6	4	0.67	1	1.19 ¹	● 189170
1.8	0.35	1.36	40	5.1	4	0.87	1	1.39 ¹	● 189171
2	0.4	1.5	40	5.6	4	0.94	1	1.54 ¹	● 189172
2.5	0.45	1.94	40	7	4	1.31	1	1.98 ¹	● 189173
3	0.5	2.38	51	8.3	5	1.68	2	2.45 ²	● 193422
3.5	0.6	2.75	51	9.7	6	1.91	2	2.85 ²	● 193423
4	0.7	3.13	51	11.1	6	2.15	2	3.25 ²	● 193424
5	0.8	4	51	13.7	8	2.88	2	4.1 ²	● 193425
6	1	4.75	51	16.5	8	3.35	2	4.9 ²	● 193426
$\emptyset D_1$ M	P mm	d_1 mm	l_1 mm	l_3 mm	d_2 h6 mm	d_3 mm			ID
1.4	0.3	1.03	40	4.7	4	0.61	1	1.05 ¹	● 189174
1.6	0.35	1.16	40	5.4	4	0.67	1	1.19 ¹	● 189175
1.8	0.35	1.36	40	6	4	0.87	1	1.39 ¹	● 189176
2	0.4	1.5	40	6.6	4	0.94	1	1.54 ¹	● 189177
2.5	0.45	1.94	40	8.2	4	1.31	1	1.98 ¹	● 189178
3	0.5	2.38	51	9.8	5	1.68	2	2.45 ²	● 193432
3.5	0.6	2.75	51	11.4	6	1.91	2	2.85 ²	● 193433
4	0.7	3.13	51	13.1	6	2.15	2	3.25 ²	● 193434
5	0.8	4	51	16.2	8	2.88	2	4.1 ²	● 193435
6	1	4.75	51	19.5	8	3.35	2	4.9 ²	● 193436

¹ Tol. = +0/0.02mm / ² Tol. = +0/0.03mm

GWi

GWi5066VS





GWi5067VS

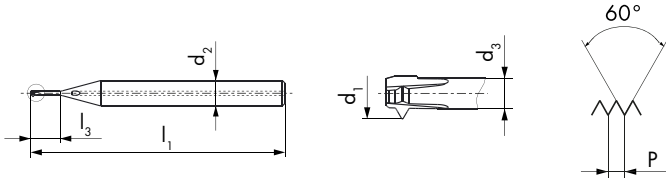

GWi5066VS

GWi5067VS





Ø" D ₁ UNC	P TPI	d ₁ mm	l ₁ mm	l ₃ mm	d ₂ h6 mm	d ₃ mm		
4	40	2.05	51	8.1	5	1.16	2	2.15 ¹
6	32	2.51	51	10	6	1.4	2	2.65 ¹
1/4	20	4.76	51	17.8	8	2.98	2	5 ¹

ID

- 193427
- 193428
- 193429

¹  Tol. = +0/0.03mm

Ø" D ₁ UNC	P TPI	d ₁ mm	l ₁ mm	l ₃ mm	d ₂ h6 mm	d ₃ mm		
4	40	2.05	51	9.5	5	1.16	2	2.15 ¹
6	32	2.51	51	11.8	6	1.4	2	2.65 ¹
1/4	20	4.76	51	21	8	2.98	2	5 ¹

ID

- 193437
- 193438
- 193439

¹  Tol. = +0/0.03mm

GWi

GWi5066VS



GWi5067VS



GWi5066VS

GWi5067VS

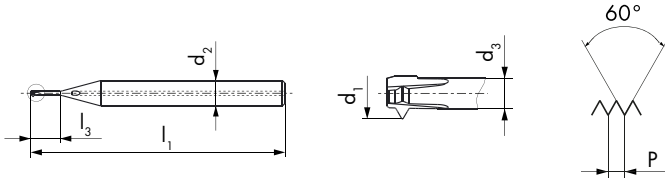

Ø" D ₁ UNF	P TPI	d ₁ mm	l ₁ mm	l ₃ mm	d ₂ h6 mm	d ₃ mm		
10	32	3.83	51	13.3	8	2.72	2	3.95 ¹
1/4	28	5.22	51	17.3	8	3.95	2	5.4 ¹

ID

- 193430
- 193431

¹ Tol. = +0/0.03mm

Ø" D ₁ UNF	P TPI	d ₁ mm	l ₁ mm	l ₃ mm	d ₂ h6 mm	d ₃ mm		
10	32	3.83	51	15.7	8	2.72	2	3.95 ¹
1/4	28	5.22	51	20.5	8	3.95	2	5.4 ¹

ID

- 193440
- 193441

¹ Tol. = +0/0.03mm

GWi

GWi5066VS



GWi5066VS



LH-rot.

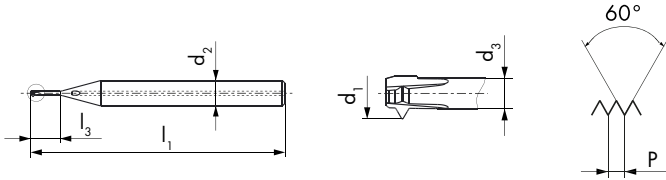

$\frac{\emptyset D_1}{S}$	P mm	d_1 mm	l_1 mm	l_3 mm	d_2 h6 mm	d_3 mm			ID
0.8	0.2	0.55	40	2.3	3	0.27	1	0.59 ¹	● 189204
0.9	0.225	0.62	40	2.6	3	0.31	1	0.67 ¹	● 189205
1	0.25	0.66	40	2.9	3	0.31	1	0.74 ¹	● 189206
1.2	0.25	0.86	40	3.4	3	0.51	1	0.94 ¹	● 189207
1.4	0.3	1.03	40	4	4	0.61	1	1.09 ¹	● 189208

¹ Tol. = +0/0.01mm

C

C315VS

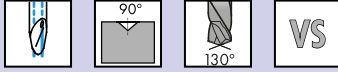

C315VS

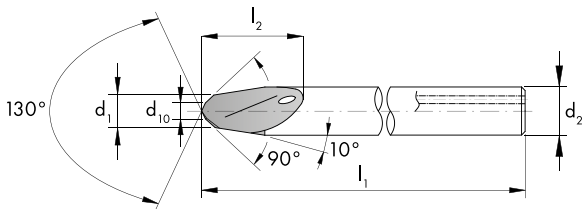

$\emptyset d_1$	l_1 mm	l_2 mm	d_2 h6 mm	d_{10} mm		ID
1.4	40	6	3	0.5	2	● 182872
2	40	6.2	3	1	2	● 182873
3	40	6.3	3	1.5	2	● 182874
4	50	8	4	2	2	● 190331
6	60	12	6	3	2	● 190332
8	70	16	8	4	2	● 190333

FZ

FZ315VS

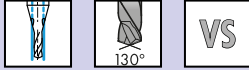

FZ315VS



FZ315VS

FZ315VS

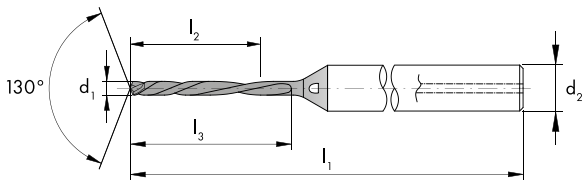

$\emptyset d_1$	D_1 mm	l_1 mm	l_2 mm	l_3 mm	d_2 h6 mm		ID
0.58	M0.8	42	4.6	5.7	3	2	● 182863
0.59	S0.8	42	4.7	5.8	3	2	● 188023
0.65	M0.9	45	5.2	6.4	3	2	● 182864
0.67	S0.9	45	5.4	6.6	3	2	● 188024
0.7	M1	45	5.6	6.9	3	2	● 182865
0.74	S1	45	5.9	7.3	3	2	● 188025
0.9	M1.2	45	7.2	8.8	3	2	● 182866
0.94	S1.2	48	7.5	9.2	3	2	● 188026
1.05	M1.4	48	8.4	10.3	3	2	● 182867
1.09	S1.4	48	8.7	10.7	3	2	● 188027
1.19	M1.6	48	9.5	11.7	3	2	● 182868
1.39	M1.8	52	11.1	13.6	4	2	● 182869
1.54	M2	55	12.3	15.1	4	2	● 182870
1.98	M2.5	55	15.8	19.4	4	2	● 182871
$\emptyset d_1$	D_1 mm	l_1 mm	l_2 mm	l_3 mm	d_2 h6 mm		ID
2.15	UNC4	63	12.9	19.4	4	2	● 190326
2.45	M3	65	14.7	22.1	4	2	● 190321
2.65	UNC6	68	15.9	23.9	4	2	● 190327
2.85	M3.5	68	17.1	25.7	4	2	● 190322
3.25	M4	74	19.5	29.3	6	2	● 190323
3.95	UNF10	78	23.7	35.6	6	2	● 190329
4.1	M5	80	24.6	36.9	6	2	● 190324
4.9	M6	84	29.4	44.1	6	2	● 190325
5	UNC1/4	84	30	45	6	2	● 190328
5.4	UNF1/4	88	32.4	48.6	6	2	● 190330

F

F286VS



F286VS

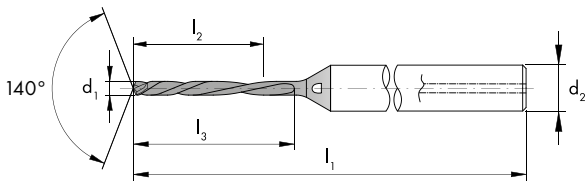

$\emptyset d_1$ (m7)	D_1 mm	l_1 mm	l_2 mm	l_3 mm	d_2 h6 mm		ID
3.3	M4	66	23	28	6	2	* 160989
4.2	M5	74	29	36	6	2	* 160990
5	M6	82	35	44	6	2	* 160991
6.8	M8	91	43	53	8	2	* 160992
8.5	M10	103	49	61	10	2	* 160993
10.2	M12	118	56	71	12	2	* 160994

GWH

GWH3015VH





GWH3017VH

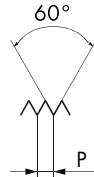
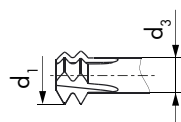
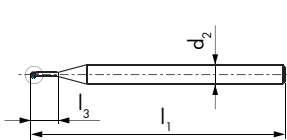

GWH3015VH

GWH3017VH





Ø D ₁ M	P mm	d ₁ mm	l ₁ mm	l ₃ mm	d ₂ h5 mm	d ₃ mm		
3	0.5	2.4	51	6.8	5	1.7	4	2.5
3.5	0.6	2.8	51	7.9	5	1.96	4	2.9
4	0.7	3.2	51	9.1	5	2.22	4	3.3
5	0.8	4	51	11.2	5	2.88	4	4.2
6	1	4.8	51	13.5	5	3.4	4	5
8	1.25	6.4	67	18	8 ¹	4.65	5	6.8
10	1.5	7.95	67	23	8 ¹	5.85	5	8.5
12	1.75	9.6	76	27	10 ¹	7.15	5	10.25

ID

- 196558
- 196559
- 196560
- 196561
- 196562
- 196563
- 196564
- 196565

¹ Tol. h6

Ø D ₁ M	P mm	d ₁ mm	l ₁ mm	l ₃ mm	d ₂ h5 mm	d ₃ mm		
3	0.5	2.4	51	9.8	5	1.7	4	2.5
3.5	0.6	2.8	51	11.4	5	1.96	4	2.9
4	0.7	3.2	51	13.1	5	2.22	4	3.3
5	0.8	4	51	16.2	5	2.88	4	4.2
6	1	4.8	51	19.5	5	3.4	4	5
8	1.25	6.4	83	26	8 ¹	4.65	5	6.8
10	1.5	7.95	83	33	8 ¹	5.85	5	8.5
12	1.75	9.6	95	39	10 ¹	7.15	5	10.25

ID

- 196582
- 196583
- 196584
- 196585
- 196586
- 196587
- 196588
- 196589

¹ Tol. h6

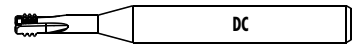

ZBGF

ZBGF6065VS



ZBGF6067VS



ZBGF6065VS

ZBGF6067VS

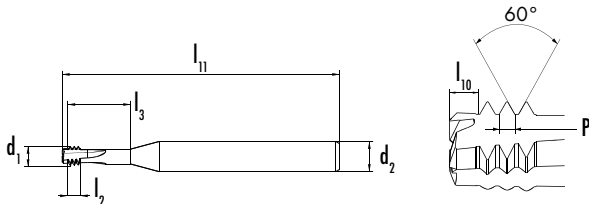

$\emptyset D_1$ M	P mm	d_1 mm	l_{11} mm	l_2 mm	l_3 mm	d_2 h6 mm	l_{10} mm	
3	0.5	2.43	55	1.5	7.5	4	0.75	3
4	0.7	3.05	55	2.1	10.1	6	1.05	3
5	0.8	4.08	55	2.4	12.4	6	1.2	3
6	1	4.5	64	3	15	6	1.5	4
8	1.25	5.95	64	3.75	19.8	6	1.88	4
10	1.5	7.95	74	4.5	24.5	8	2.25	4
12	1.75	9.95	80	5.25	29.3	10	2.63	4
16	2	11.95	92	6	38	12	3	4

ID

- 181605
- 181606
- 181607
- 181608
- 181609
- 181610
- 181611
- 181612

$\emptyset D_1$ M	P mm	d_1 mm	l_{11} mm	l_2 mm	l_3 mm	d_2 h6 mm	l_{10} mm	
3	0.5	2.43	55	1.5	10.5	4	0.75	3
4	0.7	3.05	55	2.1	14.1	6	1.05	3
5	0.8	4.08	55	2.4	17.4	6	1.2	3
6	1	4.5	72	3	21	6	1.5	4
8	1.25	5.95	72	3.75	27.8	6	1.88	4
10	1.5	7.95	90	4.5	34.5	8	2.25	4
12	1.75	9.95	102	5.25	41.3	10	2.63	4
16	2	11.95	115	6	54	12	3	4

ID

- 181613
- 181614
- 181615
- 181616
- 181617
- 181618
- 181619
- 181620

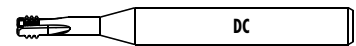

ZBGF

ZBGF6065VS



ZBGF6067VS



ZBGF6065VS	ZBGF6067VS		
------------	------------	--	--

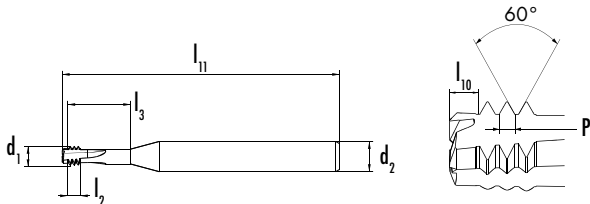

Ø" D ₁ UNC	P TPI	d ₁ mm	l ₁₁ mm	l ₂ mm	l ₃ mm	d ₂ h6 mm	l ₁₀ mm		ID
4	40	2.11	55	1.9	7.6	4	0.95	3	● 183509
6	32	2.59	55	2.4	9.4	4	1.19	3	● 183510
8	32	3.1	55	2.4	10.8	6	1.19	3	● 183511
10	24	3.6	55	3.2	12.9	6	1.59	3	● 183512
1/4	20	4.8	64	3.8	16.6	6	1.91	4	● 183513
5/16	18	5.95	64	4.2	20.2	6	2.12	4	● 183514
3/8	16	7.1	74	4.8	23.9	8	2.38	4	● 183515
1/2	13	9.95	80	5.9	31.3	10	2.93	4	● 183516
5/8	11	11.95	92	6.9	38.7	12	3.46	4	● 183517

Ø" D ₁ UNC	P TPI	d ₁ mm	l ₁₁ mm	l ₂ mm	l ₃ mm	d ₂ h6 mm	l ₁₀ mm		ID
8	32	3.1	55	2.4	14.9	6	1.19	3	● 183520
1/4	20	4.8	72	3.8	22.9	6	1.91	4	● 183522
5/16	18	5.95	72	4.2	28.1	6	2.12	4	● 183523
3/8	16	7.1	90	4.8	33.4	8	2.38	4	● 183524
1/2	13	9.95	102	5.9	44	10	2.93	4	● 183525
5/8	11	11.95	115	6.9	54.6	12	3.46	4	● 183526

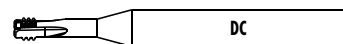

ZBGF

ZBGF6065VS



ZBGF6067VS



ZBGF6065VS

ZBGF6067VS

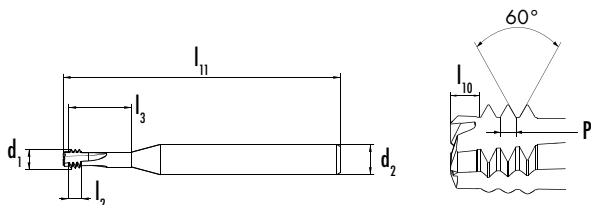

Ø" D ₁ UNF	P TPI	d ₁ mm	l ₁₁ mm	l ₂ mm	l ₃ mm	d ₂ h6 mm	l ₁₀ mm	
4	48	2.23	55	1.6	7.3	4	0.79	3
8	36	3.1	55	2.1	10.5	6	1.06	3
10	32	3.91	55	2.4	12.1	6	1.19	3
1/4	28	4.8	64	2.7	15.5	6	1.36	4
5/16	24	5.95	64	3.2	19.1	6	1.59	4
3/8	24	7.1	74	3.2	22.3	8	1.59	4
7/16	20	7.95	74	3.8	26.1	8	1.91	4
1/2	20	9.95	80	3.8	29.3	10	1.91	4
5/8	18	11.95	92	4.2	36	12	2.12	4

ID

- 183527
- 183528
- 183529
- 183530
- 183531
- 183532
- 183533
- 183534
- 183535

Ø" D ₁ UNF	P TPI	d ₁ mm	l ₁₁ mm	l ₂ mm	l ₃ mm	d ₂ h6 mm	l ₁₀ mm	
4	48	2.23	55	1.6	10.2	4	0.79	3
8	36	3.1	55	2.1	14.7	6	1.06	3
10	32	3.91	55	2.4	16.9	6	1.19	3
1/4	28	4.8	72	2.7	21.8	6	1.36	4
5/16	24	5.95	72	3.2	27	6	1.59	4
3/8	24	7.1	90	3.2	31.8	8	1.59	4
7/16	20	7.95	90	3.8	37.2	8	1.91	4
1/2	20	9.95	102	3.8	42	10	1.91	4
5/8	18	11.95	115	4.2	51.9	12	2.12	4

ID

- 183536
- 183537
- 183538
- 183539
- 183540
- 183541
- 183542
- 183543
- 183544



**EL TODO TERRENO
MAS COMPLETO**

QUE LAS MAQUINAS JAMAS HAYAN VISTO
MÁS INFORMACIÓN EN DCSWISS.COM/ES/DESCARGA

**THE MOST
PERFECT ALLROUNDER**
THAT A CNC MACHINE HAS EVER FACED
MORE INFORMATION UNDER DCSWISS.COM/EN/DOWNLOAD



VERSIONES ESPECIALES

Les proponemos un amplio programa estándar, apoyado sobre las normas técnicas actuales y las necesidades de nuestros clientes. Si no encuentran la herramienta adecuada para el trabajo a realizar les haremos llegar una oferta para fabricación especial de la herramienta óptima.

SPECIAL EXECUTIONS

We offer you a wide range of standard products, based on today's technical standards and the general needs of our customers. If you should not find in our standard programme the right tool for your workpiece to be machined, we will gladly make you an offer for the custom-made threading tool in special execution, adapted to your application.



GFMS

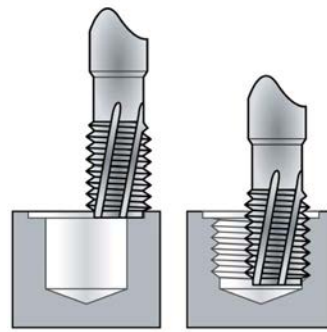
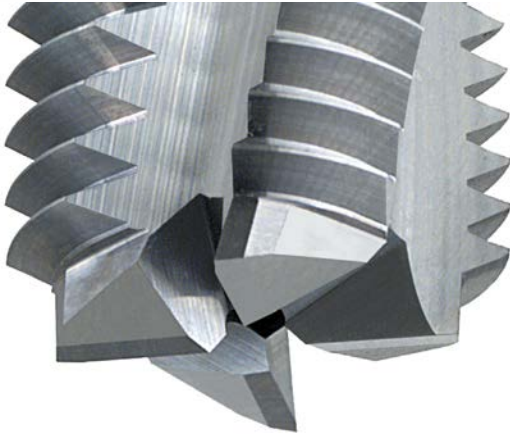

Corte frontal
Spot facing cutter

GFMS

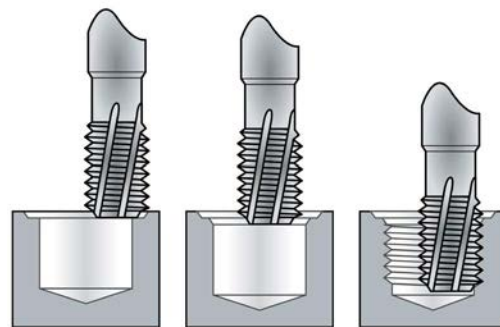
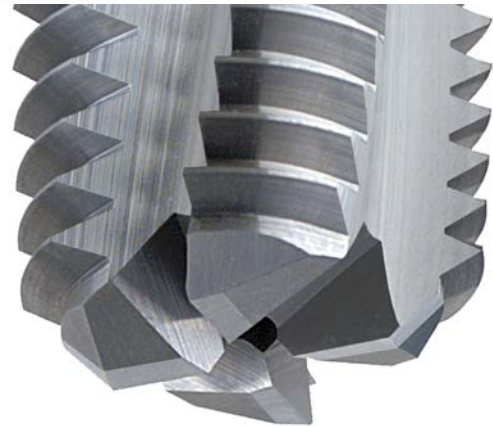

Corte frontal + corte circular con chaflán a 45°
Spot facing cutter + circular cutter with 45° bevel

BGFS

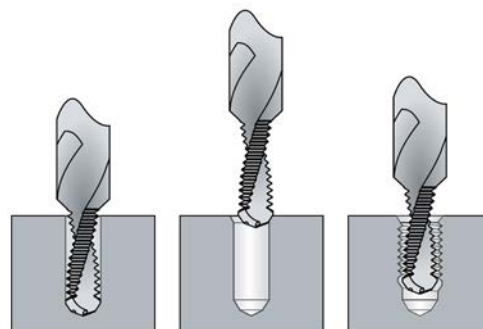

Con corte circular a 45° para achaflanar
With 45° circular chamfer for countersinking

TABLA DE UTILIZACIÓN GF - GFH - GFS - GFM APPLICATION CHART GF - GFH - GFS - GFM

Ciclo de programación para fresas de roscar GF - GFH - GFS - GFM
Programming cycle for thread milling cutters GF - GFH - GFS - GFM

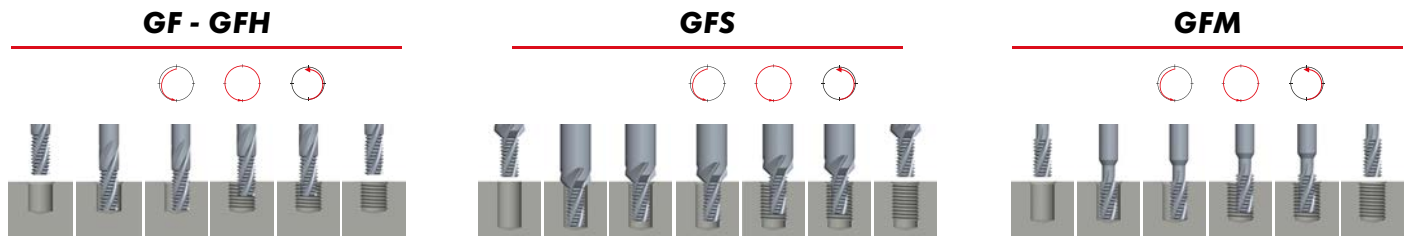

DC Tabla de utilización para fresas de roscar

DC Application chart for thread milling cutters

Grupos de materiales Material groups	Clasificación de los materiales	Material designation	Dureza Hardness (HB)	Resistencia Tensile strength Rm (N/mm ²)	Lubricante Lubricant		
					Estándar Standard	Recub. Coated	
10 Aceros Steels	11	Aceros de decoletaje	Free-cutting steels	< 200	< 700		OE
	12	Aceros de construcción o de cementación	Structural, cementation steels	< 200	< 700		OE
	13	Aceros al carbón	Carbon steels	< 300	< 1000		OE
	14	Aceros aleados < 850 N/mm ²	Alloy steels < 850 N/mm ²	< 250	< 850		OE
	15	Aceros aleados/trat. > 850 - < 1150 N/mm ²	Alloy steels hard. / temp. > 850 - < 1150 N/mm ²	> 250	> 850		OE
	16	Aceros de alta resistencia ≤ 44 HRC	High tensile alloy steels ≤ 44 HRC	> 250	> 850		OE
	17	Aceros templados y revenidos > 44 - ≤ 54 HRC	Alloy steels tempered > 44 - ≤ 54 HRC	> 410	> 1400		OE
	18	Aceros templados > 54 - ≤ 63 HRC	Alloy steels hardened > 54 - ≤ 63 HRC	> 560	> 1980		A
20 Aceros inoxidables Stainless steels	21	Aceros inoxidables al azufre	Free machining stainless steels	< 250	< 850		OE
	22	Austeníticos	Austenitic stainless steels	< 250	< 850		OE
	23	Ferríticos y martensíticos < 850 N/mm ²	Ferritic and martensitic < 850 N/mm ²	< 250	< 850		OE
	24	Ferríticos y martensíticos > 850 - < 1150 N/mm ²	Ferritic and martensitic > 850 - < 1150 N/mm ²	> 250	> 850		OE
30 Fundición Cast iron	31	Fundición gris	Cast iron	< 250	< 850		OE A
	32	Fundición de grafito + esferoidal y maleable	Spheroidal graphite + malleable cast iron	< 250	< 850		OE
40 Titanio Titanium	41	Titanio puro	Pure titanium	< 250	< 850	OE	OE
	42	Aleación al titanio	Titanium alloys	> 250	> 850	OE	OE
50 Níquel Nickel	51	Aleación al Níquel 1 ≤ 850 N/mm ²	Nickel alloys 1 ≤ 850 N/mm ²	< 250	< 850		OE
	52	Aleación al Níquel 2 > 850 - ≤ 1150 N/mm ²	Nickel alloys 2 > 850 - ≤ 1150 N/mm ²	> 250	> 850		OE
	53	Aleación al Níquel 3 > 1150 - ≤ 1600 N/mm ²	Nickel alloys 3 > 1150 - ≤ 1600 N/mm ²	> 340	> 1150		OE
60 Cobre Copper	61	Cobre puro (electrolítico)	Pure copper (electrolytic copper)	< 120	< 400		OE
	62	Latón, bronce (virutas cortas)	Short chip brass, phosphor bronze, gun metal	< 200	< 700	OE A	OE A
	63	Latón (virutas largas)	Long chip brass	< 200	< 700	OE	OE
70 Aluminio Magnesio Aluminium Magnesium	71	Al no aleado	Al unalloyed	< 100	< 350	OE	OE
	72	Al aleado Si < 1.5 %	Al alloyed Si < 1.5 %	< 150	< 500	OE	OE
	73	Al aleado Si > 1.5 % - < 10 %	Al alloyed Si > 1.5 % - < 10 %	< 120	< 400		OE
	74	Al aleado Si > 10 %, Aleaciones Magnesio	Al alloyed Si > 10 %, Mg-alloys	< 120	< 400		OE
80 Materiales plásticos Plastic compounds	81	Materiales termoplásticos	Thermoplastics	-	-	E	E
	82	Materiales duroplásticos	Duroplastics	-	-	E	E
	83	Materiales plásticos reforzados por fibras	Glass fibre reinforced plastics	-	-		E A
90 Metales preciosos Precious metals	91	Oro amarillo	Yellow gold	-	-	OE	OE
	92	Oro rojo	Red gold	-	-	OE	OE
	93	Oro blanco	White gold	-	-		OE
	94	Plata	Silver	-	-		OE

O Óptimo con aceite de corte
Optimal with cutting oil

O Aceptable con aceite de corte
Suitable with cutting oil

E Óptimo con emulsión
Optimal with emulsion

E Aceptable con emulsión
Suitable with emulsion

GF - GFH - GFS - GFM

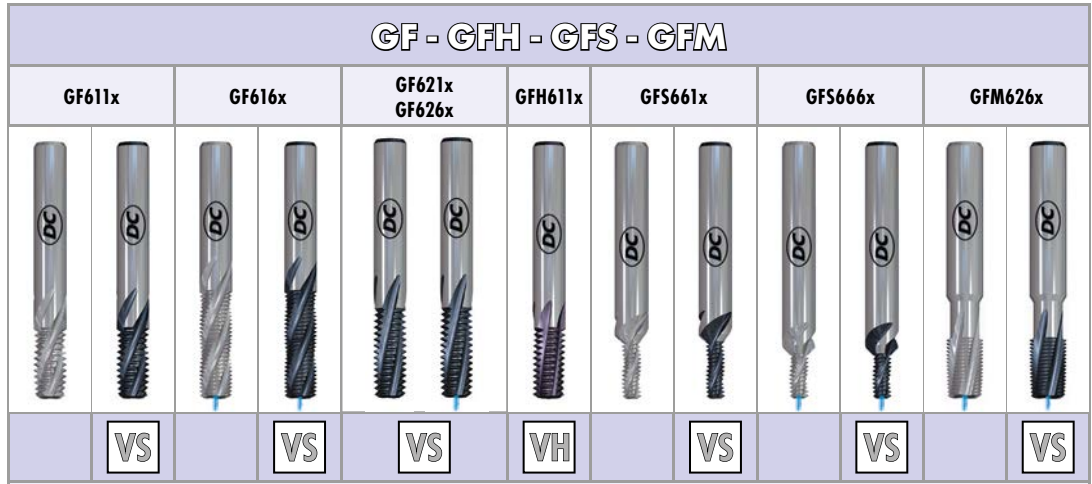

Vc (m/min)	
Estándar Standard	Recub. Coated
	80-150
	60-120
	60-120
	60-120
	50-90
	30-60
	30-50
	20-40
	50-90
	30-60
	50-90
	30-60
	80-150
	80-120
40-70	60-100
20-40	30-60
	30-60
	30-60
	20-30
	200-250
150-200	200-250
150-200	200-250
100-250	100-250
100-250	100-250
	100-250
	100-250
100-200	100-200
50-100	50-100
50-100	60-80
50-100	100-150
	50-90
	30-50
	90-120

		Avance fz (mm/diente)						Milling fz (mm/tooth)							
			0.04-0.15		0.04-0.15		0.04-0.15			0.04-0.15		0.04-0.15		0.04-0.15	11
			0.04-0.15		0.04-0.15		0.04-0.15			0.04-0.15		0.04-0.15		0.04-0.15	12
			0.02-0.10		0.02-0.10		0.02-0.10			0.02-0.10		0.02-0.10		0.02-0.10	13
			0.02-0.10		0.02-0.10		0.02-0.10			0.02-0.10		0.02-0.10		0.02-0.10	14
			0.02-0.08		0.02-0.08		0.02-0.08			0.02-0.08		0.02-0.08		0.02-0.08	15
			0.01-0.05		0.01-0.05		0.01-0.05	0.01-0.05		0.01-0.05		0.01-0.05		0.01-0.05	16
			0.008-0.035		0.008-0.035		0.008-0.035	0.008-0.035		0.008-0.035		0.008-0.035		0.008-0.035	17
							0.005-0.02								18
			0.02-0.10		0.02-0.10		0.02-0.10			0.02-0.10		0.02-0.10		0.02-0.10	21
			0.01-0.05		0.01-0.05		0.01-0.05			0.01-0.05		0.01-0.05		0.01-0.05	22
			0.02-0.08		0.02-0.08		0.02-0.08			0.02-0.08		0.02-0.08		0.02-0.08	23
			0.01-0.05		0.01-0.05		0.01-0.05			0.01-0.05		0.01-0.05		0.01-0.05	24
			0.05-0.15		0.05-0.15		0.05-0.15	0.05-0.15		0.05-0.15		0.05-0.15		0.05-0.15	31
			0.02-0.10		0.02-0.10		0.02-0.10			0.02-0.10		0.02-0.10		0.02-0.10	32
40-70	60-100	0.02-0.08	0.02-0.08	0.02-0.08	0.02-0.08	0.02-0.08		0.02-0.08	0.02-0.08	0.02-0.08	0.02-0.08	0.02-0.08	0.02-0.08	0.02-0.08	41
20-40	30-60	0.01-0.05	0.01-0.05	0.01-0.05	0.01-0.05	0.01-0.05		0.01-0.05	0.01-0.05	0.01-0.05	0.01-0.05	0.01-0.05	0.01-0.05	0.01-0.05	42
	30-60		0.02-0.08		0.02-0.08		0.02-0.08			0.02-0.08		0.02-0.08		0.02-0.08	51
	30-60		0.02-0.08		0.02-0.08		0.02-0.08			0.02-0.08		0.02-0.08		0.02-0.08	52
	20-30		0.005-0.02		0.005-0.02		0.005-0.02			0.005-0.02		0.005-0.02		0.005-0.02	53
	200-250		0.05-0.15		0.05-0.15		0.05-0.15			0.05-0.15		0.05-0.15		0.05-0.15	61
150-200	200-250	0.05-0.15	0.05-0.15	0.05-0.15	0.05-0.15	0.05-0.15	0.05-0.15	0.05-0.15	0.05-0.15	0.05-0.15	0.05-0.15	0.05-0.15	0.05-0.15	0.05-0.15	62
150-200	200-250	0.05-0.15	0.05-0.15	0.05-0.15	0.05-0.15	0.05-0.15		0.05-0.15	0.05-0.15	0.05-0.15	0.05-0.15	0.05-0.15	0.05-0.15	0.05-0.15	63
100-250	100-250	0.05-0.20	0.05-0.20	0.05-0.20	0.05-0.20	0.05-0.20		0.05-0.20	0.05-0.20	0.05-0.20	0.05-0.20	0.05-0.20	0.05-0.20	0.05-0.20	71
100-250	100-250	0.05-0.20	0.05-0.20	0.05-0.20	0.05-0.20	0.05-0.20		0.05-0.20	0.05-0.20	0.05-0.20	0.05-0.20	0.05-0.20	0.05-0.20	0.05-0.20	72
	100-250		0.05-0.20		0.05-0.20		0.05-0.20			0.05-0.20		0.05-0.20		0.05-0.20	73
	100-250		0.05-0.15		0.05-0.15		0.05-0.15			0.05-0.15		0.05-0.15		0.05-0.15	74
100-200	100-200	0.05-0.20	0.05-0.20	0.05-0.20	0.05-0.20	0.05-0.20		0.05-0.20	0.05-0.20	0.05-0.20	0.05-0.20	0.05-0.20	0.05-0.20	0.05-0.20	81
50-100	50-100	0.04-0.15	0.04-0.15	0.04-0.15	0.04-0.15	0.04-0.15		0.04-0.15	0.04-0.15	0.04-0.15	0.04-0.15	0.04-0.15	0.04-0.15	0.04-0.15	82
50-100	60-80		0.04-0.15		0.04-0.15		0.04-0.15			0.04-0.15		0.04-0.15		0.04-0.15	83
50-100	100-150	0.05-0.15	0.05-0.15	0.05-0.15	0.05-0.15	0.05-0.15		0.05-0.15	0.05-0.15	0.05-0.15	0.05-0.15	0.05-0.15	0.05-0.15	0.05-0.15	91
50-90	90-120	0.05-0.15	0.05-0.15	0.05-0.15	0.05-0.15	0.05-0.15		0.05-0.15	0.05-0.15	0.05-0.15	0.05-0.15	0.05-0.15	0.05-0.15	0.05-0.15	92
	30-50		0.05-0.15		0.05-0.15		0.05-0.15			0.05-0.15		0.05-0.15		0.05-0.15	93
	90-120		0.05-0.15		0.05-0.15		0.05-0.15			0.05-0.15		0.05-0.15		0.05-0.15	94

A Óptimo con aire
Optimal with air

A Aceptable con aire
Suitable with air

Los valores son indicativos.
The indicated values are a guideline.



TABLA DE UTILIZACIÓN BGF— APPLICATION CHART BGF

Ciclo de programación para fresas de taladrar/roscar BGF
 Programming cycle for thrillers BGF

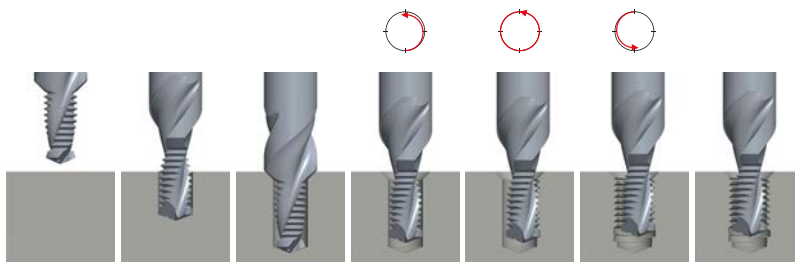

DC Tabla de utilización para fresas de taladrar/roscar

DC Application chart for thrillers

Grupos de materiales Material groups	Clasificación de los materiales	Material designation	Dureza Hardness (HB)	Resistencia Tensile strength Rm (N/mm ²)	Lubricante Lubricant		
					Estándar Standard	Recub. Coated	
10 Aceros Steels	11	Aceros de decoletaje	Free-cutting steels	< 200	< 700		
	12	Aceros de construcción o de cementación	Structural, cementation steels	< 200	< 700		
	13	Aceros al carbón	Carbon steels	< 300	< 1000		
	14	Aceros aleados < 850 N/mm ²	Alloy steels < 850 N/mm ²	< 250	< 850		
	15	Aceros aleados/trat. > 850 - < 1150 N/mm ²	Alloy steels hard./ temp. > 850 - < 1150 N/mm ²	> 250	> 850		
	16	Aceros de alta resistencia ≤ 44 HRC	High tensile alloy steels ≤ 44 HRC	> 250	> 850		
	17	Aceros templados y revenidos > 44 - ≤ 54 HRC	Alloy steels tempered > 44 - ≤ 54 HRC	> 410	> 1400		
	18	Aceros templados > 54 - ≤ 63 HRC	Alloy steels hardened > 54 - ≤ 63 HRC	> 560	> 1980		
20 Aceros inoxidables Stainless steels	21	Aceros inoxidables al azufre	Free machining stainless steels	< 250	< 850		
	22	Austeníticos	Austenitic stainless steels	< 250	< 850		
	23	Ferríticos y martensíticos < 850 N/mm ²	Ferritic and martensitic < 850 N/mm ²	< 250	< 850		
	24	Ferríticos y martensíticos > 850 - < 1150 N/mm ²	Ferritic and martensitic > 850 - < 1150 N/mm ²	> 250	> 850		
30 Fundición Cast iron	31	Fundición gris	Cast iron	< 250	< 850		OE
	32	Fundición de grafito + esferoidal y maleable	Spheroidal graphite + malleable cast iron	< 250	< 850		OE
40 Titanio Titanium	41	Titanio puro	Pure titanium	< 250	< 850		
	42	Aleación al titanio	Titanium alloys	> 250	> 850		
50 Níquel Nickel	51	Aleación al Níquel 1 ≤ 850 N/mm ²	Nickel alloys 1 ≤ 850 N/mm ²	< 250	< 850		
	52	Aleación al Níquel 2 > 850 - ≤ 1150 N/mm ²	Nickel alloys 2 > 850 - ≤ 1150 N/mm ²	> 250	> 850		
	53	Aleación al Níquel 3 > 1150 - ≤ 1600 N/mm ²	Nickel alloys 3 > 1150 - ≤ 1600 N/mm ²	> 340	> 1150		
60 Cobre Copper	61	Cobre puro (electrolítico)	Pure copper (electrolytic copper)	< 120	< 400		
	62	Latón, bronce (virutas cortas)	Short chip brass, phosphor bronze, gun metal	< 200	< 700	OE	OE
	63	Latón (virutas largas)	Long chip brass	< 200	< 700	OE	OE
70 Aluminio Magnesio Aluminium Magnesium	71	Al no aleado	Al unalloyed	< 100	< 350	OE	OE
	72	Al aleado Si < 1.5 %	Al alloyed Si < 1.5 %	< 150	< 500	OE	OE
	73	Al aleado Si > 1.5 % - < 10 %	Al alloyed Si > 1.5 % - < 10 %	< 120	< 400	OE	OE
	74	Al aleado Si > 10 %, Aleaciones Magnesio	Al alloyed Si > 10 %, Mg-alloys	< 120	< 400	OE	OE
80 Materiales plásticos Plastic compounds	81	Materiales termoplásticos	Thermoplastics	-	-		
	82	Materiales duroplásticos	Duroplastics	-	-		
	83	Materiales plásticos reforzados por fibras	Glass fibre reinforced plastics	-	-		E
90 Metales preciosos Precious metals	91	Oro amarillo	Yellow gold	-	-	OE	OE
	92	Oro rojo	Red gold	-	-		
	93	Oro blanco	White gold	-	-		
	94	Plata	Silver	-	-		

O Óptimo con aceite de corte
Optimal with cutting oil

O Aceptable con aceite de corte
Suitable with cutting oil

E Óptimo con emulsión
Optimal with emulsion

E Aceptable con emulsión
Suitable with emulsion

BGF



Vc (m/min)		VS		VS		
Estándar Standard	Recub. Coated	Avance taladro f (mm/rev.)	Drilling f (mm/rev.)	Avance fresado fz (mm/diente)	Milling fz (mm/tooth)	
						11
						12
						13
						14
						15
						16
						17
						18
						21
						22
						23
						24
	80-150		0.10-0.30		0.05-0.15	31
	80-120		0.10-0.20		0.02-0.10	32
						41
						42
						51
						52
						53
						61
100-200	150-300	0.10-0.40	0.10-0.40	0.05-0.20	0.05-0.20	62
100-200	150-300	0.10-0.40	0.10-0.40	0.05-0.20	0.05-0.20	63
100-200	150-300	0.10-0.40	0.10-0.40	0.05-0.20	0.05-0.20	71
100-200	150-300	0.10-0.40	0.10-0.40	0.05-0.20	0.05-0.20	72
100-200	150-300	0.10-0.40	0.10-0.40	0.05-0.20	0.05-0.20	73
100-200	150-250	0.10-0.30	0.10-0.30	0.05-0.15	0.05-0.15	74
						81
						82
	80-120		0.10-0.20		0.02-0.10	83
100-200	150-300	0.10-0.40	0.10-0.40	0.05-0.20	0.05-0.20	91
						92
						93
						94

A Óptimo con aire
Optimal with air

A Aceptable con aire
Suitable with air

Los valores son indicativos.
The indicated values are a guideline.

Notas técnicas

Δ La ejecución del taladrado en materiales de viruta larga debe realizarse en varias pasadas.

Δ Para la utilización de la fresa de taladrar/roscar tipo BGF en otro tipo de materiales, deben dirigirse a DC SWISS SA.



























Technical notes

Δ When machining long chipping materials, they may require deburring operations.

Δ Please ask DC SWISS SA before using BGF type thrillers in materials where no cutting data is given.









Directorio - Fresas de roscar en metal duro integral tipo GF
Directory - Solid carbide thread milling cutters type GF

		GF																									
Tipo Type		GF6110		GF6110VS		GF6160		GF6160VS		GF6115		GF6115VS		GF6165		GF6165VS		GF6116		GF6116VS		GF6166		GF6166VS			
Recubrimiento Coating				VS				VS				VS				VS				VS				VS			
																											
Longitud roscada Thread length																											
Características Characteristics																											
M	ISO DIN 13	104						105		105		106		106													
MF	ISO DIN 13	107								108		108		108													
UNC	ASME B1.1	109								110		110		110													
UNF	ASME B1.1	111								112		112		112													
UN	ASME B1.1																										
UNEF	ASME B1.1																										
UNS	ASME B1.1																										
G (BSP)	DIN EN ISO 228									113		113		113													
NPT	ASME B1.20.1			114		114		114		114		114		114													
NPTF	ANSI B1.20.3			114		114		114		114		114		114													















Directorio - Fresas de roscar en metal duro integral tipo GF, GFH y GFS
Directory - Solid carbide thread milling cutters type GF, GFH and GFS

		GF		GFH	GFS							
Tipo Type		GF6215VS	GF6265VS	GFH6110VH	GF6610	GF6610VS	GF6660	GF6660VS	GF6615	GF6615VS	GF6665	GF6665VS
Recubrimiento Coating		VS	VS	VH		VS		VS		VS		VS
Longitud roscada Thread length												
Características Characteristics				 HRC ≤ 63								
M	ISO DIN 13	115	115	104		117		117		118		118
MF	ISO DIN 13		115			120		120		121		121
UNC	ASME B1.1	116	116			122		122		123		123
UNF	ASME B1.1	116	116			124		124		125		125
UN	ASME B1.1											
UNEF	ASME B1.1											
UNS	ASME B1.1											
G (BSP)	DIN EN ISO 228							126				126
NPT	ASME B1.20.1							127				
NPTF	ANSI B1.20.3							127				

Directorio - Fresas de roscar en metal duro integral tipo GFS y GFM
Directory - Solid carbide thread milling cutters type GFS and GFM

		GFS		GFM			
Tipo Type		GFS6616	GFS6616VS	GFS6666	GFS6666VS	GFM6260	GFM6260VS
Recubrimiento Coating			VS		VS		VS
							
Longitud roscada Thread length							
Características Characteristics							
M	ISO DIN 13		119		119		128
MF	ISO DIN 13						128
UNC	ASME B1.1						129
UNF	ASME B1.1						129
UN	ASME B1.1						129
UNEF	ASME B1.1						129
UNS	ASME B1.1						129
G (BSP)	DIN EN ISO 228						130
NPT	ASME B1.20.1						131
NPTF	ANSI B1.20.3						131

Directorio - Fresas de taladrar/roscar en metal duro integral tipo BGF
Directory - Solid carbide thrillers type BGF

		BGF									
Tipo Type		BGF6760 BGF6760VS		BGF6765 BGF6765VS		BGF6766 BGF6766VS		BGF6865 BGF6865VS		BGF6866 BGF6866VS	
Recubrimiento Coating		VS		VS		VS		VS		VS	
											
Longitud roscada Thread length											
Características Characteristics											
M ISO DIN 13		132		133		133		134		134	
MF ISO DIN 13		135		135							

Fórmula de cálculo para el avance de la fresa

$$\begin{aligned} \text{Avance en contorno} \quad V_{fK} &= fz \times Z \times n \\ \text{Avance centro del útil} \quad V_{fM} &= \frac{V_{fK} \times (\text{\textcircled{Ø}} \text{ nominal del roscado} - \text{\textcircled{Ø}} \text{ de la fresa de roscar})}{\text{\textcircled{Ø}} \text{ nominal del roscado}} \end{aligned}$$

Para las máquinas CN que no calculan automáticamente el avance del centro del útil, el valor "avance centro del útil V_{fM} " debe tomarse en consideración.

Thread milling feed rates

$$\begin{aligned} \text{Feed rate} \quad V_{fK} &= fz \times Z \times n \\ \text{Feed rate of the tool middle} \quad V_{fM} &= \frac{V_{fK} \times (\text{nominal thread } \text{\textcircled{Ø}} - \text{\textcircled{Ø}} \text{ of the thread milling cutter})}{\text{nominal thread } \text{\textcircled{Ø}}} \end{aligned}$$

On CNC machines, which do not calculate for themselves the feed rate at the tool-centre, the value "centre of the tool V_{fM} " must be considered.

GF - GFH

GF6110



GF6110VS



GFH6110VH

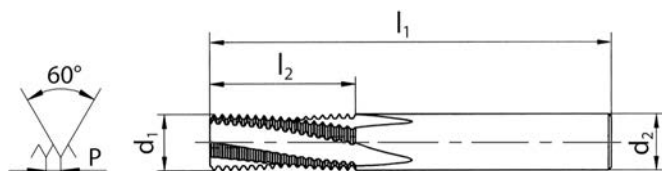

GF6110

GF6110VS

GFH6110VH



HRC
≤ 63

Ø D ₁ M	P mm	d ₁ mm	l ₁ mm	l ₂ mm	d ₂ mm	GF	GFH		ID	ID	ID
2	0.4	1.5	48	3.4	6	2		1.6	● 125233	● 115993	
2.5	0.45	1.9	48	4.3	6	3		2.05	● 150565	● 152124	
3	0.5	2.3	48	5.3	6	3	3	2.5	● 125660	● 116395	● 150072
3.5	0.6	2.7	48	6.3	6	3		2.9	● 116350	● 135217	
4	0.7	3	48	7.4	6	3	3	3.3	● 125944	● 116396	● 150073
5	0.8	3.8	48	9.2	6	3	4	4.2	● 126158	● 116397	● 150074
6	1	4.5	54	10.5	6		4	5			● 150075
8	1.25	5.95	54	13.1	6		5	6.8			● 150076
10	1.5	7.95	64	17.3	8		5	8.5			● 150077
12	1.75	9.95	74	20.1	10		5	10.2			● 151326

GF

GF6115



GF6115VS



GF6165



GF6165VS

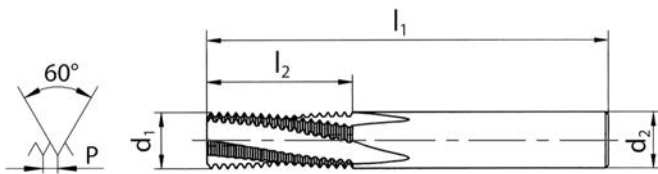
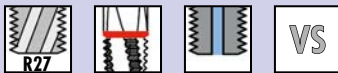

GF6115



GF6115VS



GF6165



GF6165VS



$\varnothing D_1$ M	P mm	d_1 mm	l_1 mm	l_2 mm	d_2 mm		
4	0.7	3	48	8.8	6	3	3.3
5	0.8	3.8	48	10.8	6	3	4.2
6	1	4.5	54	13.5	6	3	5
8	1.25	5.95	54	18.1	6	3	6.8
10	1.5	7.95	64	21.8	8	4	8.5
12	1.75	9.95	72	25.4	10	4	10.2
14	2	9.95	74	31	10	4	12
16	2	11.95	80	35	12	4	14
18	2.5	13.95	90	41.3	14	4	15.5
20							17.5

ID

ID

ID

ID

● 146298

● 146969

● 146299

● 146970

● 146300

● 146971

● 126350

● 116398

● 146321

● 146972

● 126586

● 116399

● 146322

● 146973

● 124836

● 116400

● 116342

● 116401

● 125066

● 116402

● 125114

● 115990

● 125229

● 116403

GF

GF6116



GF6116VS



GF6166



GF6166VS

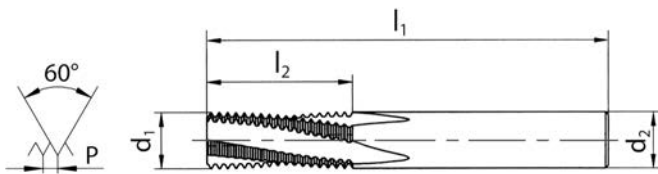
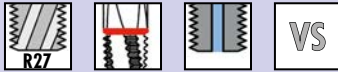

GF6116



GF6116VS





























GF6166

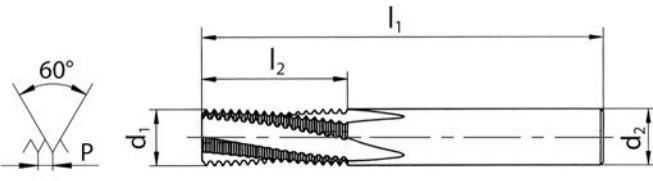

GF6166VS



$\emptyset D_1$ M	P mm	d_1 mm	l_1 mm	l_2 mm	d_2 mm			ID	ID	ID	ID
4	0.7	3	48	10.9	6	3		● 155365	● 155370		
5	0.8	3.8	48	13.2	6	3		● 155366	● 155371		
6	1	4.5	54	16.5	6	3		● 155367	● 155372	● 155375	● 155382
8	1.25	5.95	54	21.9	6	3		● 155368	● 155373	● 155376	● 155383
10	1.5	7.95	64	26.3	8	4		● 155369	● 155374	● 155377	● 155384
12	1.75	9.95	74	32.4	10	4				● 155378	● 155385
14	2	9.95	74	37	10	4				● 155379	● 155386
16	2	11.95	90	43	12	4				● 155380	● 155387
18	2.5	13.95	105	53.8	14	4				● 155381	● 155388
20											

GF									GF6110	GF6110VS						
<p>GF6110  </p> <p>GF6110VS   </p>									 							
									 							
 																
$\emptyset D_1$ MF	P mm	d_1 mm	l_1 mm	l_2 mm	d_2 mm				ID	ID						
4	0.5	3	48	7.3	6	3		3.5	● 135218	● 135219						
5	0.5	3.8	48	8.8	6	3		4.5	● 135069	● 135220						

GF

GF6165



GF6165VS

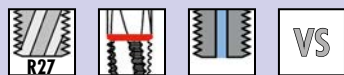

GF6166



GF6166VS

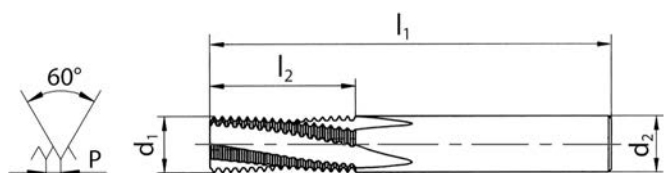
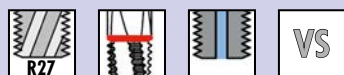

GF6165



GF6165VS



GF6166



GF6166VS



Ø D ₁ MF	P mm	d ₁ mm	l ₁ mm	l ₂ mm	d ₂ mm		
6	0.5	4.5	54	12.8	6	3	5.5
6	0.75	4.5	54	13.1	6	3	5.25
8	0.5	5.95	54	17.8	6	3	7.5
8	0.75	5.95	54	16.9	6	3	7.25
8	1	5.95	54	17.5	6	3	7
10	1	7.95	64	21.5	8	4	9
10	1.25	7.95	64	21.9	8	4	8.8
12	1	9.95	72	25.5	10	4	11
12	1.5	9.95	72	26.3	10	4	10.5

ID

ID

● 135221	● 135222
● 123664	● 123665
● 135002	● 135223
● 143110	● 135224
● 124239	● 116404
● 119986	● 116405
● 120102	● 116406
● 120303	● 116407
● 120392	● 120393

Ø D ₁ MF	P mm	d ₁ mm	l ₁ mm	l ₂ mm	d ₂ mm		
6	0.5	4.5	54	15.8	6	3	5.5
6	0.75	4.5	54	16.1	6	3	5.25
8	0.5	5.95	54	20.8	6	3	7.5
8	0.75	5.95	54	20.6	6	3	7.25
8	1	5.95	54	21.5	6	3	7
10	1	7.95	64	26.5	8	4	9
10	1.25	7.95	64	26.9	8	4	8.8
12	1	9.95	74	31.5	10	4	11
12	1.5	9.95	74	32.3	10	4	10.5

ID

ID

● 155389	● 155398
● 155390	● 155399
* 155391	* 155400
● 155392	● 155401
* 155393	* 155402
● 155394	● 155403
* 155395	* 155404
● 155396	● 155405
● 155397	● 155406

UNC ASME B1.1

VHM
CAR



HB
HE

sur demande
auf Anfrage
on request
su richiesta
sobre pedido

GF

GF6110



GF6110VS



GF6110

GF6110VS

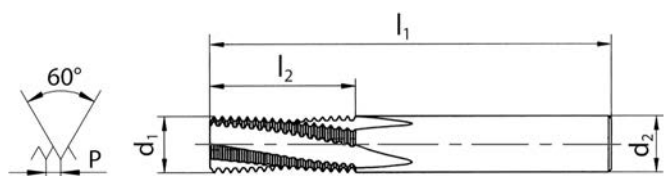

$\emptyset'' D_1$ UNC	P TPI	d_1 mm	l_1 mm	l_2 mm	d_2 mm			ID	ID
10	24	3.6	48	10.1	6	3		● 135225	● 135226
12	24	4.1	48	10.1	6	3		● 135227	● 135228
1/4	20	4.8	54	12.1	6	3		● 135229	● 135230

GF

GF6165

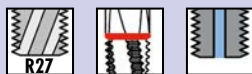

GF6165VS

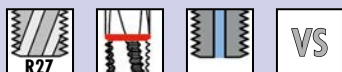

GF6166



GF6166VS

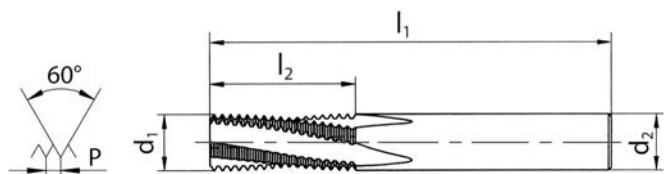
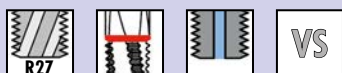

GF6165



GF6165VS



GF6166



GF6166VS



$\emptyset'' D_1$ UNC	P TPI	d_1 mm	l_1 mm	l_2 mm	d_2 mm		
1/4	20	4.8	54	14.6	6	3	5.1
5/16	18	5.95	54	17.6	6	3	6.5
3/8	16	7.1	64	21.5	8	4	8
7/16	14	7.95	64	24.5	8	4	9.3
1/2	13	9.95	72	28.4	10	4	10.8

ID

ID

* 155407

* 155408

● 116047

● 135231

● 135232

● 135233

* 116049

* 135234

* 135235

* 135236

$\emptyset'' D_1$ UNC	P TPI	d_1 mm	l_1 mm	l_2 mm	d_2 mm		
1/4	20	4.8	54	17.1	6	3	5.1
5/16	18	5.95	54	21.9	6	3	6.5
3/8	16	7.1	64	26.2	8	4	8
7/16	14	7.95	64	29.9	8	4	9.3
1/2	13	9.95	74	34.2	10	4	10.8

ID

ID

● 155409

● 155414

● 155410

● 155415

● 155411

● 155416

● 155412

● 155417

● 155413

● 155418

UNF ASME B1.1

VHM
CAR

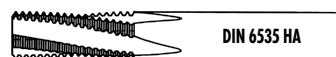

HB
HE

sur demande
auf Anfrage
on request
su richiesta
sobre pedido

GF

GF6110



GF6110VS



GF6110

GF6110VS

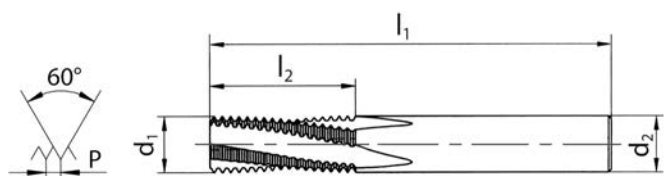

$\emptyset'' D_1$ UNF	P TPI	d_1 mm	l_1 mm	l_2 mm	d_2 mm		
10	32	3.6	48	8.3	6	3	4.05
12	28	4.1	48	9.5	6	3	4.6
1/4	28	4.8	54	11.3	6	3	5.5

ID

ID

- | | |
|----------|----------|
| ● 128659 | ● 135237 |
| ● 135238 | ● 135239 |
| ● 135240 | ● 135176 |

UNF ASME B1.1

VHM
CAR

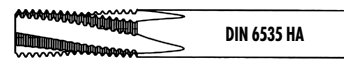

HB
HE sur demande
auf Anfrage
on request
su richiesta
sobre pedido

GF

GF6165



GF6165VS

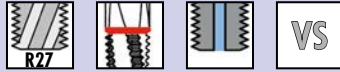

GF6166



GF6166VS

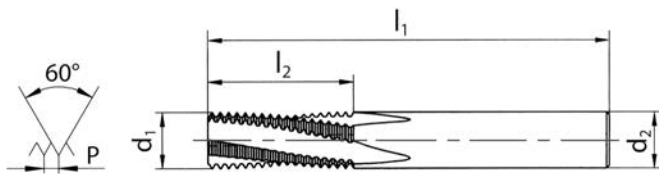
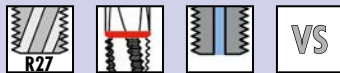

GF6165



GF6165VS



GF6166



GF6166VS



$\emptyset'' D_1$ UNF	P TPI	d_1 mm	l_1 mm	l_2 mm	d_2 mm		
1/4	28	4.8	54	14.1	6	3	5.5
5/16	24	5.95	54	17.5	6	3	6.9
3/8	24	7.1	64	20.6	8	4	8.5
7/16	20	7.95	64	24.8	8	4	9.8
1/2	20	9.95	72	27.3	10	4	11.4

ID

ID

- | | |
|----------|----------|
| ● 155419 | ● 155420 |
| ● 135242 | ● 135243 |
| ● 135182 | ● 135245 |
| ● 135246 | ● 135247 |
| ● 135183 | ● 135249 |

$\emptyset'' D_1$ UNF	P TPI	d_1 mm	l_1 mm	l_2 mm	d_2 mm		
1/4	28	4.8	54	16.8	6	3	5.5
5/16	24	5.95	54	20.6	6	3	6.9
3/8	24	7.1	64	24.9	8	4	8.5
7/16	20	7.95	64	28.6	8	4	9.8
1/2	20	9.95	74	33.7	10	4	11.4

ID

ID

- | | |
|----------|----------|
| ● 155421 | ● 155426 |
| ● 155422 | ● 155427 |
| ● 155423 | ● 155428 |
| ● 155424 | ● 155429 |
| ● 155425 | ● 155430 |

G DIN EN ISO 228 (BSP)

VHM
CAR



HB
HE sur demande
auf Anfrage
on request
su richiesta
sobre pedido

GF

GF6165



GF6165VS

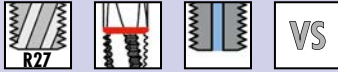

GF6166



GF6166VS

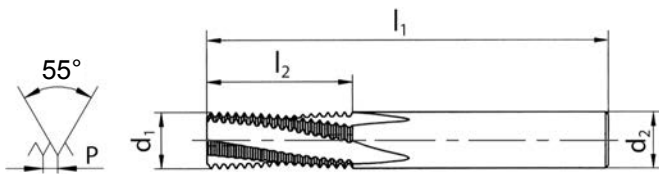
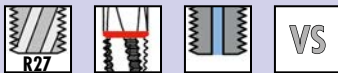

GF6165



GF6165VS



GF6166



GF6166VS



$\emptyset'' D_1$ G	P TPI	d_1 mm	l_1 mm	l_2 mm	d_2 mm		
1/8	28	7.95	64	21.3	8	4	8.75
1/4	19	9.95	72	28.7	10	4	11.6
3/8	19	13.6	80	35.4	14	4	15.2

ID

ID

● 119347

● 116409

● 119292

● 116410

● 119678

● 116411

$\emptyset'' D_1$ G	P TPI	d_1 mm	l_1 mm	l_2 mm	d_2 mm		
1/8	28	7.95	64	24.9	8	4	8.75
1/4	19	9.95	74	34.1	10	4	11.6
3/8	19	13.6	90	43.4	14	4	15.2

ID

ID

● 155431

● 155434

● 155432

● 155435

● 155433

● 155436

NPT, NPTF

ASME B1.20.1
ANSI B1.20.3

VHM
CAR

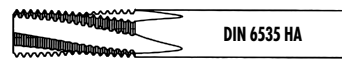

HB
HE

sur demande
auf Anfrage
on request
su richiesta
sobre pedido

GF

GF6160



GF6160VS

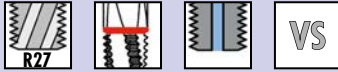

GF6160

GF6160VS

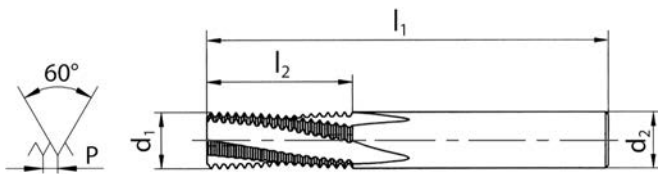

Ø" D ₁ NPT	P TPI	d ₁ mm	l ₁ mm	l ₂ mm	d ₂ mm	
1/8	27	7.3	64	9.9	8	4
1/4	18	9.95	72	14.8	12	4
3/8	18	12.5	80	14.8	14	4
1/2	14	14.7	90	19.1	16	4

ID	ID
● 116371	● 116435
● 135250	● 135251
● 135252	● 135253
● 155437	● 155438

Ø" D ₁ NPTF	P TPI	d ₁ mm	l ₁ mm	l ₂ mm	d ₂ mm	
1/8	27	7.3	64	9.9	8	4
3/8	18	12.5	80	14.8	12	4
1/2	14	14.7	90	19.1	14	4

ID	ID
* 135254	
* 135258	* 135259
* 155439	* 155440

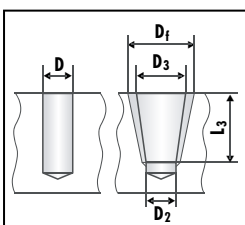

Ø" D ₁	D	D ₂	NPT NPTF	
			D ₃ (+0.05)	
1/8	8.5	8.3	8.74	8.76
1/4	11.0	10.8	11.36	11.40
3/8	14.5	14.2	14.80	14.84
1/2	17.9	17.5	18.32	18.33

Fresado Milling	
D _f	L ₃
9.81	6.92
12.99	10.02
16.41	10.33
20.37	13.57

M, MF ISO DIN 13

VHM
CAR

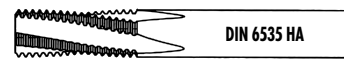

HB
HE

sur demande
auf Anfrage
on request
su richiesta
sobre pedido

GF

GF6215VS



GF6265VS



GF6215VS

GF6265VS

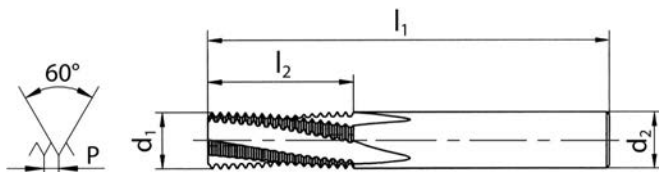

Ø D ₁ M	P mm	d ₁ mm	l ₁ mm	l ₂ mm	d ₂ mm			ID	ID
4	0.7	3	48	8.8	6	3	3.3	● 196068	
5	0.8	3.8	48	10.8	6	3	4.2	● 196069	
6	1	4.5	54	13.5	6	3	5	● 196070	● 196080
8	1.25	5.95	54	18.1	6	3	6.8	● 196071	● 196081
10	1.5	7.95	64	21.8	8	4	8.5	● 196072	● 196082
12	1.75	9.95	72	25.4	10	4	10.2	● 196073	● 196083
14	2	9.95	74	31	10	4	12		● 196084
16	2	11.95	80	35	12	4	14		● 196085
18	2.5	13.95	90	43.8	14	4	15.5		● 196086
20	2.5	13.95	90	43.8	14	4	17.5		● 196087

Ø D ₁ MF	P mm	d ₁ mm	l ₁ mm	l ₂ mm	d ₂ mm			ID	ID
6	0.75	4.5	54	13.1	6	3	5.25	● 196090	● 196099
8	1	5.95	54	17.5	6	3	7	● 196091	● 196100
10	1	7.95	64	21.5	8	4	9	● 196092	● 196101
10	1.25	7.95	64	21.9	8	4	8.8	● 196093	● 196102
12	1	9.95	72	25.5	10	4	11		● 197113
12	1.5	9.95	72	26.3	10	4	10.5	● 196094	● 196103
14	1.5	9.95	74	30.8	10	4	12.5		● 196104
16	1.5	11.95	80	33.8	12	4	14.5		● 196105
18	1.5	13.95	90	42.8	14	4	16.5		● 196106
20	1.5	13.95	90	42.8	14	4	18.5		● 196107

UNC, UNF ASME B1.1

VHM
CAR

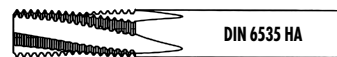

HB
HE

sur demande
auf Anfrage
on request
su richiesta
sobre pedido

GF

GF6215VS



GF6265VS



GF6215VS

GF6265VS

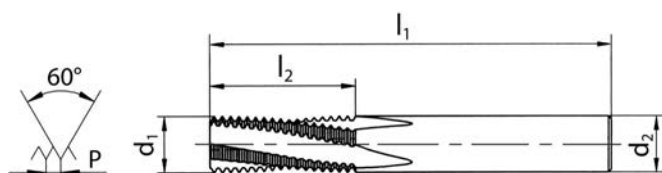

Ø" D ₁ UNC	P TPI	d ₁ mm	l ₁ mm	l ₂ mm	d ₂ mm		
8	32	3.1	48	9.1	6	3	3.4
10	24	3.6	48	10.1	6	3	3.8
1/4	20	4.8	54	14.6	6	3	5.1
5/16	18	5.95	54	17.6	6	3	6.5
3/8	16	7.1	64	21.5	8	4	8
7/16	14	7.95	64	24.5	8	4	9.3
1/2	13	9.95	72	28.4	10	4	10.8
5/8	11	11.95	80	35.8	12	4	13.6
3/4	10	13.95	90	41.9	14	4	16.6

ID

ID

● 196109

● 196110

● 196111

● 196118

● 196112

● 196119

● 196113

● 196120

● 196114

● 196121

● 196115

● 196122

● 196123

● 196124

Ø" D ₁ UNF	P TPI	d ₁ mm	l ₁ mm	l ₂ mm	d ₂ mm		
10	32	3.6	48	8.3	6	3	4.05
1/4	28	4.8	54	14.1	6	3	5.5
5/16	24	5.95	54	17.5	6	3	6.9
3/8	24	7.1	64	20.6	8	4	8.5
7/16	20	7.95	64	24.8	8	4	9.8
1/2	20	9.95	72	27.3	10	4	11.4
5/8	18	11.95	80	34.6	12	4	14.5
3/4	16	13.95	90	40.5	14	4	17.5

ID

ID

● 196125

● 196126

● 196133

● 196127

● 196134

● 196128

● 196135

● 196129

● 196136

● 196130

● 196137

● 196138

● 196139

GFS

GFS6610



GFS6610VS



GFS6660



GFS6660VS

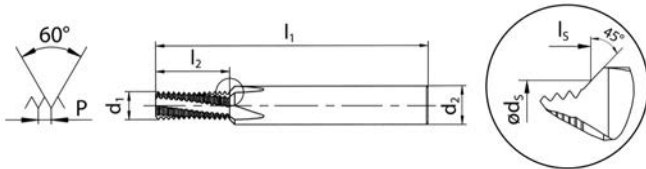

GFS6610



GFS6610VS



GFS6660



GFS6660VS



Ø D ₁ M	P mm	d ₁ mm	l ₁ mm	l ₂ mm	l ₃ mm	d ₂ mm	d ₂ mm			ID	ID	ID	ID
2	0.4	1.5	48	3.4	3.7	2.1	6	2	1.6	* 135331	* 135332		
2.5	0.45	1.9	48	4.3	4.6	2.6	6	3	2.05	* 155441	* 155443		
3	0.5	2.3	48	5.3	5.7	3.1	6	3	2.5	● 135333	● 135334		
3.5	0.6	2.7	48	5.7	6.2	3.6	6	3	2.9	* 155442	* 155444		
4	0.7	3	48	7.4	7.9	4.1	6	3	3.3	● 135335	● 135336		
5	0.8	3.8	54	9.2	9.9	5.1	6	3	4.2	● 135337	● 135338		
6	1	4.5	62	10.5	11.4	6.2	8	3	5	● 135339	● 116175		
8	1.25	5.95	74	13.1	14.3	8.2	10	3	6.8			● 135340	● 116172
10	1.5	7.95	80	17.3	18.4	10.3	12	4	8.5			● 135341	● 116173
12	1.75	9.95	90	20.1	21.3	12.3	14	4	10.2			* 135342	* 116174
14	2	10.8	102	25	26.8	14.4	16	4	12			* 135343	* 135344
16	2	12.8	102	27	28.8	16.4	18	4	14			* 135345	* 135346
18	2.5	13.95	125	33.8	36	18.5	25	4	15.5			* 135347	* 135348
20					37	20.5			17.5				

GFS

GFS6615



GFS6615VS



GFS6665



GFS6665VS

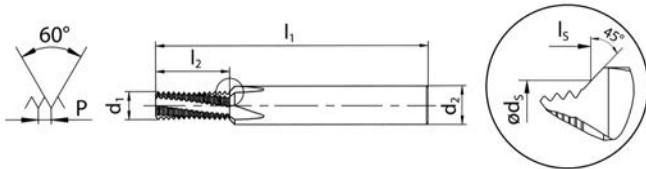

GFS6615



GFS6615VS



GFS6665



GFS6665VS



Ø D ₁ M	P mm	d ₁ mm	l ₁ mm	l ₂ mm	l ₃ mm	d _{min}	d ₂ mm	✎	✎	ID	ID	ID	ID
2	0.4	1.5	48	4.6	4.9	2.1	6	2	1.6	* 135349	* 135350		
2.5	0.45	1.9	48	5.6	6	2.6	6	3	2.05	* 155445	* 155447		
3	0.5	2.3	48	6.8	7.2	3.1	6	3	2.5	● 125661	● 135351		
3.5	0.6	2.7	48	7.5	8	3.6	6	3	2.9	* 155446	* 147108		
4	0.7	3	48	8.8	9.3	4.1	6	3	3.3	● 125946	● 135352		
5	0.8	3.8	54	10.8	11.5	5.1	6	3	4.2	● 126160	● 116178		
6	1	4.5	62	13.5	14.4	6.2	8	3	5	● 126352	● 135353	● 155524	● 155525
8	1.25	5.95	74	18.1	19.3	8.2	10	3	6.8			● 126587	● 116343
10	1.5	7.95	80	21.8	22.9	10.3	12	4	8.5			* 124837	* 135354
12	1.75	9.95	90	25.4	26.6	12.3	14	4	10.2			* 124973	* 135355
14	2	10.8	102	31	32.8	14.4	16	4	12			* 125067	* 135356
16	2	12.8	102	35	36.8	16.4	18	4	14			* 125116	* 135357
18	2.5	13.95	125	41.3	43.5	18.5	25	4	15.5				* 135358
20					44.5	20.5			17.5				

GFS

GFS6616



GFS6616VS



GFS6666



GFS6666VS

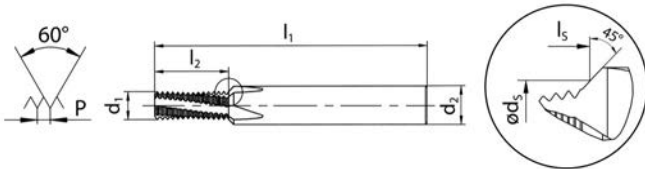

GFS6616



GFS6616VS



GFS6666



GFS6666VS



Ø D ₁ M	P mm	d ₁ mm	l ₁ mm	l ₂ mm	l ₃ mm	d ₂ mm	d ₂ mm			ID	ID	ID	ID
3	0.5	2.3	48	8.3	8.7	3.1	6	3	2.5	● 155448	● 155452		
4	0.7	3	48	10.9	11.4	4.1	6	3	3.3	● 155449	● 155453		
5	0.8	3.8	54	13.2	13.9	5.1	6	3	4.2	● 155450	● 155454		
6	1	4.5	62	16.5	17.4	6.2	8	3	5	* 155451	* 155455	● 155456	● 155463
8	1.25	5.95	74	21.9	23	8.2	10	3	6.8			● 155457	● 155464
10	1.5	7.95	80	26.3	27.4	10.3	12	4	8.5			● 155458	● 155465
12	1.75	9.95	90	32.4	33.6	12.3	14	4	10.2			* 155459	* 155466
16	2	12.8	102	43	44.8	16.4	18	4	14			* 155461	* 155468

GFS

GFS6610



GFS6610VS



GFS6660



GFS6660VS

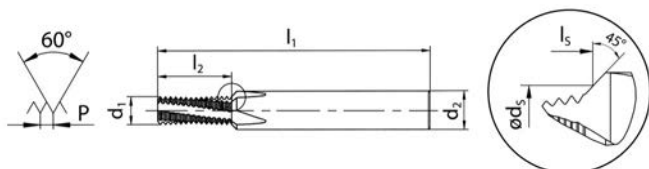

GFS6610



GFS6610VS



GFS6660



GFS6660VS



Ø D ₁ MF	P mm	d ₁ mm	l ₁ mm	l ₂ mm	l _i mm	d ₂ mm	d ₂ mm			ID	ID	ID	ID
4	0.5	3	48	7.3	7.8	4.1	6	3	3.5	* 135359	* 135360		
5	0.5	3.8	54	8.8	9.4	5.1	6	3	4.5	* 135361	* 135362		
6	0.5	4.5	62	9.8	10.6	6.2	8	3	5.5	* 135363	* 135364		
6	0.75	4.5	62	10.1	11	6.2	8	3	5.25	* 135365	* 135366		
8	0.5	5.95	74	12.8	13.9	8.2	10	3	7.5			* 135367	* 135368
8	0.75	5.95	74	13.1	14.3	8.2	10	3	7.25			* 135369	* 135370
8	1	5.95	74	13.5	14.6	8.2	10	3	7			* 135371	* 135372
10	1	7.95	80	16.5	17.7	10.3	12	4	9			* 135373	* 135374
10	1.25	7.95	80	16.9	18.1	10.3	12	4	8.8			* 135375	* 135376
12	1	9.95	90	19.5	20.7	12.3	14	4	11			* 135377	* 135378
12	1.5	9.95	90	20.3	21.4	12.3	14	4	10.5			* 135379	* 135380
14	1.5	10.8	102	23.3	25.1	14.4	16	4	12.5			* 135381	* 135382
16	1.5	12.8	102	26.3	28.1	16.4	18	4	14.5			* 135383	* 135384

GFS

GFS6615



GFS6615VS



GFS6665



GFS6665VS

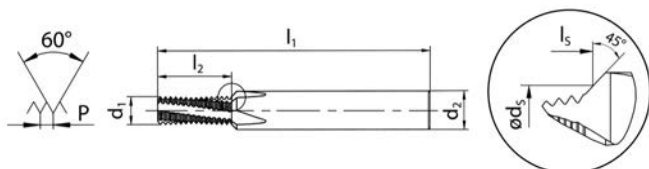

GFS6615



GFS6615VS



GFS6665



GFS6665VS



Ø D ₁ MF	P mm	d ₁ mm	l ₁ mm	l ₂ mm	l _s mm	d ₂ mm	d ₂ mm			ID	ID	ID	ID
4	0.5	3	48	8.8	9.3	4.1	6	3	3.5	● 135385	● 135386		
5	0.5	3.8	54	10.8	11.4	5.1	6	3	4.5	● 135387	● 135388		
6	0.5	4.5	62	12.8	13.6	6.2	8	3	5.5	★ 135389	★ 135390		
6	0.75	4.5	62	13.1	14	6.2	8	3	5.25	★ 135391	★ 135392		
8	0.5	5.95	74	17.8	18.9	8.2	10	3	7.5			★ 135393	★ 135394
8	0.75	5.95	74	16.9	18	8.2	10	3	7.25			● 135395	● 135396
8	1	5.95	74	17.5	18.6	8.2	10	3	7			★ 135397	★ 135398
10	1	7.95	80	21.5	22.7	10.3	12	4	9			★ 135399	★ 135400
10	1.25	7.95	80	21.9	23.1	10.3	12	4	8.8			★ 135401	★ 135402
12	1	9.95	90	25.5	26.7	12.3	14	4	11			★ 135403	★ 135404
12	1.5	9.95	90	26.3	27.4	12.3	14	4	10.5			★ 135405	★ 135406
14	1.5	10.8	102	30.8	32.6	14.4	16	4	12.5			★ 135407	★ 135408
16	1.5	12.8	102	33.8	35.6	16.4	18	4	14.5			● 135409	● 135410

GFS

GFS6610



GFS6610VS



GFS6660



GFS6660VS

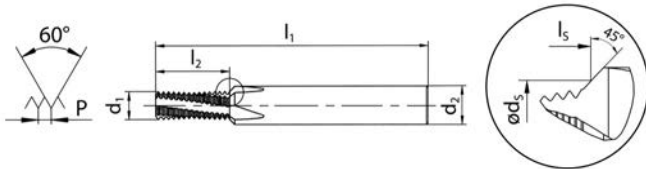

GFS6610



GFS6610VS





GFS6660



GFS6660VS



\emptyset'' UNC	P TPI	d_1 mm	l_1 mm	l_2 mm	l_3 mm	d_1 mm	d_2 mm			ID	ID	ID	ID
12	24	4.1	54	10.1	10.8	5.6	6	3	4.4	* 135422	* 135423		
1/4	20	4.8	62	12.1	12.9	6.5	8	3	5.1	* 135424	* 135425	* 155470	* 155473
5/16	18	5.95	74	14.8	15.9	8.1	10	3	6.5	* 135426	* 135427	* 155471	* 155474
3/8	16	7.1	80	16.7	18	9.8	12	4	8	* 135428	* 135429	* 155472	* 155475
7/16	14	7.95	80	19.1	20.8	11.4	12	4	9.3			* 135430	* 135431
1/2	13	9.95	90	22.5	24	13	14	4	10.8			* 135432	* 135433
9/16	12	10.8	102	24.4	26.2	14.6	16	4	12.2			* 135434	* 135435
5/8	11	11.9	102	26.5	28.8	16.3	18	4	13.6			* 135436	* 135437

GFS

GFS6615



GFS6615VS



GFS6665



GFS6665VS

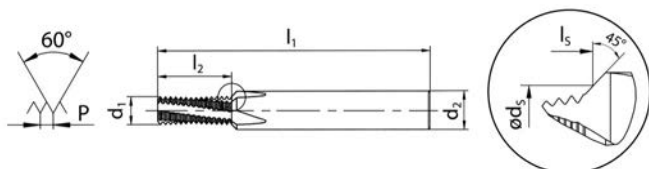

GFS6615



GFS6615VS



GFS6665



GFS6665VS



\emptyset'' D ₁ UNC	P TPI	d ₁ mm	l ₁ mm	l ₂ mm	l ₃ mm	d ₂ mm	d ₂ mm			ID	ID	ID	ID
10	24	3.6	54	12.2	12.8	4.9	6	3	3.8	* 135438	* 135439		
12	24	4.1	54	13.2	14	5.6	6	3	4.4	* 135440	* 135441		
1/4	20	4.8	62	14.6	15.5	6.5	8	3	5.1	* 135442	* 135443	* 155476	* 155479
5/16	18	5.95	74	17.6	18.7	8.1	10	3	6.5	* 135444	* 135445	* 155477	* 155480
3/8	16	7.1	80	21.5	22.8	9.8	12	4	8	* 135446	* 135447	* 155478	* 155481
7/16	14	7.95	80	24.5	26.2	11.4	12	4	9.3			* 135448	* 135449
1/2	13	9.95	90	28.4	29.9	13	14	4	10.8			* 135450	* 135451
9/16	12	10.8	102	32.8	34.7	14.6	16	4	12.2			* 135452	* 135453
5/8	11	11.9	102	35.8	38	16.3	18	4	13.6			* 135454	* 135455

GFS

GFS6610



GFS6610VS

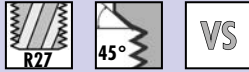

GFS6660



GFS6660VS

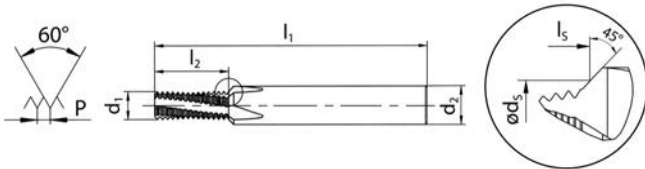

GFS6610



GFS6610VS





GFS6660



GFS6660VS



$\emptyset'' D_1$ UNF	P TPI	d_1 mm	l_1 mm	l_2 mm	l_3 mm	d_3 mm	d_2 mm			ID	ID	ID	ID
12	28	4.1	54	9.5	10.3	5.6	6	3	4.6	* 135458	* 135459		
1/4	28	4.8	62	11.3	12.2	6.5	8	3	5.5	* 135460	* 135461	* 155482	* 155485
5/16	24	5.95	74	13.2	14.3	8.1	10	3	6.9	* 135462	* 135463	* 155483	* 155486
3/8	24	7.1	80	16.4	17.7	9.8	12	4	8.5	* 135464	* 135465	* 155484	* 155487
1/2	20	9.95	90	21	22.5	13	14	4	11.4			* 135468	* 135469
5/8	18	11.9	102	26.1	28.3	16.3	18	4	14.5			* 135472	* 135473

GFS

GFS6615



GFS6615VS



GFS6665



GFS6665VS

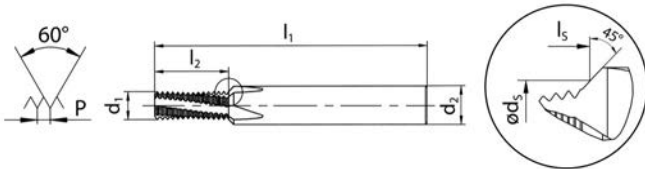

GFS6615



GFS6615VS



GFS6665



GFS6665VS



$\emptyset'' D_1$ UNF	P TPI	d_1 mm	l_1 mm	l_2 mm	l_3 mm	d_2 mm	d_2 mm			ID	ID	ID	ID
10	32	3.6	54	11.5	12.2	4.9	6	3	4.05	● 128660	● 135474		
12	28	4.1	54	12.3	13	5.6	6	3	4.6	* 135475	* 135476		
1/4	28	4.8	62	14.1	14.9	6.5	8	3	5.5	● 128578	● 135477	* 155488	* 155491
5/16	24	5.95	74	17.5	18.5	8.1	10	3	6.9	* 135478	* 135479	* 155489	* 155492
3/8	24	7.1	80	20.6	22	9.8	12	4	8.5	* 135480	* 135481	* 155490	* 155493
7/16	20	7.95	80	24.8	26.5	11.4	12	4	9.8			* 135482	* 135483
1/2	20	9.95	90	27.3	28.8	13	14	4	11.4			* 135484	* 135485
5/8	18	11.9	102	34.6	36.8	16.3	18	4	14.5			* 135488	* 135489

G DIN EN ISO 228 (BSP)

VHM
CAR

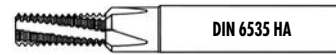

HB
HE sur demande
auf Anfrage
on request
su richiesta
sobre pedido

GFS

GFS6660



GFS6660VS



GFS6665



GFS6665VS

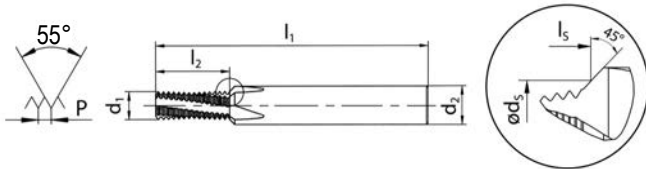

GFS6660



GFS6660VS



GFS6665



GFS6665VS



$\frac{\text{Ø}''}{\text{G}}$ D ₁	P TPI	d ₁ mm	l ₁ mm	l ₂ mm	l _s mm	d ₃ mm	d ₂ mm		
1/4	19	9.95	90	22.1	23.8	13.5	14	4	11.6
3/8	19	12.8	102	27.4	29.6	17.1	18	4	15.2

ID

ID

* 135414

* 135415

* 135416

$\frac{\text{Ø}''}{\text{G}}$ D ₁	P TPI	d ₁ mm	l ₁ mm	l ₂ mm	l _s mm	d ₃ mm	d ₂ mm		
1/8	28	7.95	80	21.3	22.3	10	12	4	8.75
1/4	19	9.95	90	28.7	30.5	13.5	14	4	11.6
3/8	19	12.8	102	35.4	37.6	17.1	18	4	15.2

ID

ID

* 119349

* 135417

* 119298

* 135418

* 119680

* 135419

NPT, NPTF

ASME B1.20.1
ANSI B1.20.3

VHM
CAR

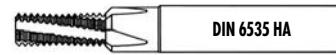

HB
HE sur demande
auf Anfrage
on request
su richiesta
sobre pedido

GFS

GFS6660



GFS6660VS



GFS6660

GFS6660VS

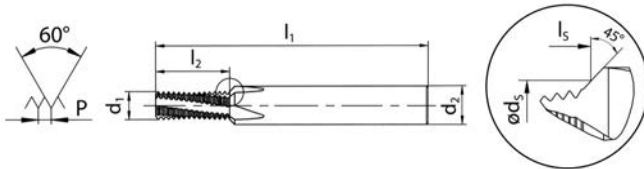
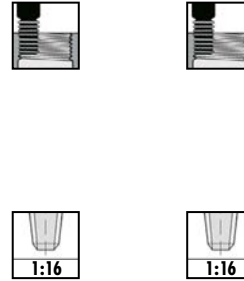

$\emptyset'' D_1$ NPT	P TPI	d_1 mm	l_1 mm	l_2 mm	l_3 mm	d_2 mm	d_2 mm		ID	ID
1/4	18	9.95	80	14.8	16.4	14	16	4	* 126899	* 135491
3/8	18	12.5	80	14.8	16.9	17.6	18	4	* 126928	

$\emptyset'' D_1$ NPTF	P TPI	d_1 mm	l_1 mm	l_2 mm	l_3 mm	d_2 mm	d_2 mm		ID	ID
1/8	27	7.3	70	9.9	11.2	10.6	12	4	* 135493	* 135494
1/4	18	9.95	80	14.8	16.4	14	16	4	* 135495	* 135496
3/8	18	12.5	80	14.8	16.9	17.6	18	4	* 135497	* 135498

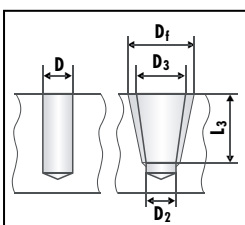

$\emptyset'' D_1$	Agujero Core hole			
	D	D_2	NPT $D_3 (+0.05)$	NPTF
1/8	8.5	8.3	8.74	8.76
1/4	11.0	10.8	11.36	11.40
3/8	14.5	14.2	14.80	14.84

Fresado Milling	
D_f	L_3
9.81	6.92
12.99	10.02
16.41	10.33

GFM

GFM6260



GFM6260VS



GFM6260

GFM6260VS

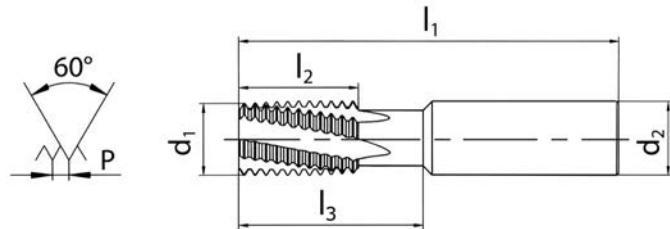
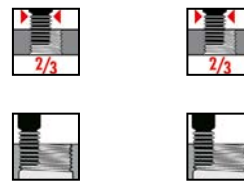

d ₁ mm	P mm	Ø D ₁ ≥ M, MF	l ₁ mm	l ₂ mm	l ₃ mm	d ₂ mm	✎	ID	ID
8	0.5	10	64	16	16	8	4	● 116450	● 135260
8	0.75	10	64	15.8	16	8	4	● 116340	● 135261
10	0.75	14	70	15.8	26	10	4	★ 116128	★ 135262
10	1	14	70	16	26	10	4	● 118657	● 135263
10	1.25	14	70	16.3	26	10	4	★ 118659	★ 135264
10	1.5	14	70	16.5	26	10	4	● 118661	● 135265
12	0.5	18	80	20	32	12	4	★ 116129	★ 135214
12	0.75	18	80	20.3	32	12	4	● 155526	● 155527
12	1	18	80	20	32	12	4	● 118664	● 135007
12	1.5	18	80	21	32	12	4	● 118669	● 135181
12	2	18	80	20	32	12	4	● 118673	● 135269
16	1	24	90	25	42	16	4	● 118680	● 135270
16	1.5	24	90	25.5	42	16	4	● 118682	● 116017
16	2	24	90	26	42	16	4	● 118684	● 135271
16	2.5	24	90	25	42	16	4	● 118689	● 135272
16	3	24	90	27	42	16	4	● 158760	● 150564
20	1	30	105	33	52	20	5	★ 135273	★ 135274
20	1.5	30	105	33	52	20	5	● 118694	● 135275
20	2	30	105	34	52	20	5	● 116338	● 135276
20	3	30	105	33	52	20	5	★ 118699	★ 135279
20	3.5	30	105	35	52	20	5	● 144195	● 144065

UN

UNC, UNF
UNEF, UNS ASME B1.1

VHM
CAR

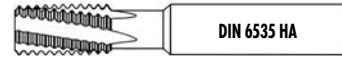

HB
HE

sur demande
auf Anfrage
on request
su richiesta
sobre pedido

GFM

GFM6260



GFM6260VS



GFM6260

GFM6260VS

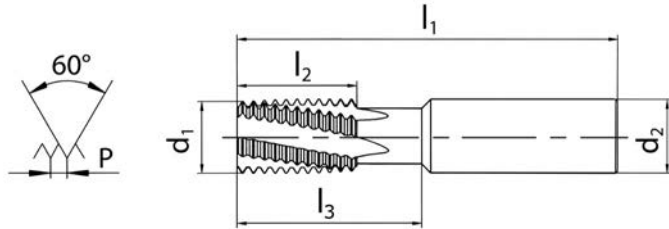

d ₁ mm	P TPI	Ø ^h D ₁ ≥ UN	l ₁ mm	l ₂ mm	l ₃ mm	d ₂ mm	⚙	ID	ID
10	24	1/2	70	15.9	26	10	4	* 135288	* 135289
12	24	3/4	80	20.1	32	12	4	* 135290	* 135291
12	20	3/4	80	20.3	32	12	4	* 135292	* 135293
12	18	3/4	80	19.8	32	12	4	* 135294	* 135295
12	16	3/4	80	20.6	32	12	4	● 135296	● 135297
12	10	3/4	80	20.3	32	12	4	* 150963	* 155494
16	24	1	90	25.4	42	16	4	* 135298	* 135299
16	20	1	90	25.4	42	16	4	* 135300	* 135301
16	18	1	90	25.4	42	16	4	* 135302	* 135303
16	16	1	90	25.4	42	16	4	* 135304	* 135305
16	14	1	90	25.4	42	16	4	● 135306	● 135307
16	12	1	90	25.4	42	16	4	● 135308	● 135309
16	9	1	90	25.4	42	16	4	* 150964	* 155495
16	8	1	90	25.4	42	16	4	* 150965	* 155496
20	24	1 1/4	105	32.8	52	20	5	* 135310	* 135311
20	20	1 1/4	105	33	52	20	5	* 135312	* 135313
20	18	1 1/4	105	32.5	52	20	5	* 135314	* 135315
20	16	1 1/4	105	33.4	52	20	5	* 118697	* 135316
20	14	1 1/4	105	32.7	52	20	5	* 135317	* 135318
20	12	1 1/4	105	31.8	52	20	5	* 135319	* 135320
20	8	1 1/4	105	31.8	52	20	5	* 135321	* 135322
20	7	1 1/4	105	32.7	52	20	5	* 150962	* 155497

G DIN EN ISO 228 (BSP)

VHM
CAR

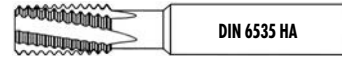

HB
HE sur demande
auf Anfrage
on request
su richiesta
sobre pedido

GFM

GFM6260



GFM6260VS



GFM6260

GFM6260VS

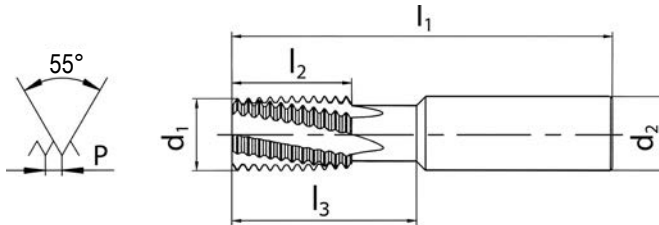
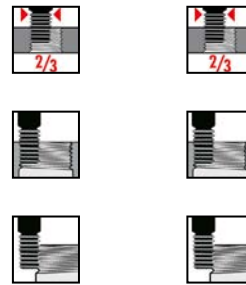

d ₁ mm	P TPI	Ø ^H D ₁ G	l ₁ mm	l ₂ mm	l ₃ mm	d ₂ mm	✎	ID	ID
10	19	1/4-3/8	70	16	26	10	4	● 118655	● 135280
16	14	1/2-7/8	90	25.4	42	16	4	● 118678	● 135281
20	11	≥ 1	105	32.3	52	20	5	● 118691	● 135282

NPT, NPTF

ASME B1.20.1
ANSI B1.20.3

VHM
CAR

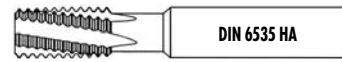

HB
HE sur demande
auf Anfrage
on request
su richiesta
sobre pedido

GFM

GFM6260



GFM6260VS



GFM6260

GFM6260VS

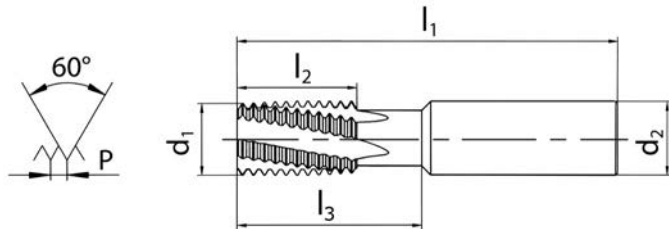

d ₁ mm	P TPI	Ø" D ₁ ≥ NPT	l ₁ mm	l ₂ mm	d ₂ mm	⚙
14.5	14	1/2	90	19.1	16	4
18.5	11.5	1	90	23.2	20	5

ID

ID

- 135323
- 135325

- 135324
- 135326

d ₁ mm	P TPI	Ø" D ₁ ≥ NPTF	l ₁ mm	l ₂ mm	d ₂ mm	⚙
14.5	14	1/2	90	19.1	16	4
18.5	11.5	1	90	23.2	20	5

ID

ID

- * 135327
- * 135329

- * 135328
- * 135330

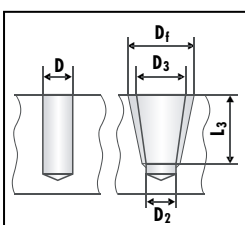

Ø" D ₁	Agujero Core hole			
	D	D ₂	NPT NPTF D ₃ (+0.05)	
1/2	17.9	17.5	18.32	18.33
3/4	23.2	22.8	23.67	23.68
1	29.0	28.6	29.69	29.72
1 1/4	37.7	37.3	38.45	38.48
1 1/2	44.0	43.5	44.52	44.55
2	56.0	55.5	56.56	56.59

Fresado Milling	
D _f	L ₃
20.37	13.57
25.69	14.05
32.18	16.79
40.90	17.30
49.67	17.30
58.99	17.70



BGF

BGF6760



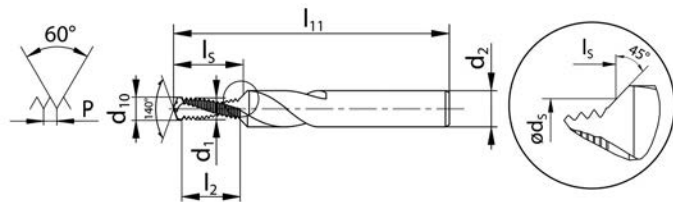

BGF6760VS

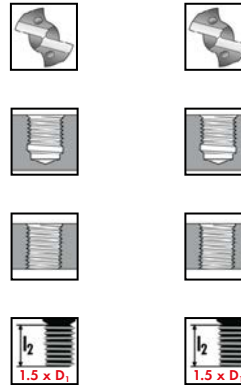

BGF6760

BGF6760VS



$\emptyset D_1$ M	P mm	d_1 mm	d_{10} mm	l_{11} mm	l_2 mm	l_3 mm	d_3 mm	d_2 mm		ID	ID
4	0.7	3.1	3.3	48	5.6	7.4	4.1	6	2	* 153400	* 153415
5	0.8	4	4.2	54	7.2	9.4	5.1	6	2	* 153401	* 153416
6	1	4.75	5	62	9	11.7	6.2	8	2	* 153402	* 153417
8	1.25	6.5	6.75	74	11.2	14.6	8.2	10	2	* 151911	* 153418
10	1.5	8.25	8.5	80	15	19.1	10.3	12	2	* 153403	* 151442
12	1.75	9.95	10.25	90	17.4	22.1	12.3	14	2	* 153404	* 153419
14	2	11.6	12	102	19.9	25.1	14.4	16	2	* 153405	* 153420
16	2	13.6	14	102	23.9	29.5	16.4	18	2	* 153406	* 153421

BGF

BGF6765



BGF6765VS



BGF6766



BGF6766VS

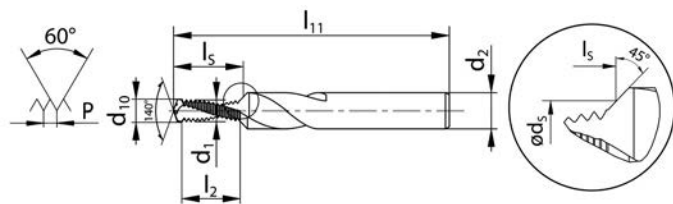

BGF6765



BGF6765VS



BGF6766



BGF6766VS



Ø D ₁ M	P mm	d ₁ mm	d ₁₀ mm	l ₁₁ mm	l ₂ mm	l ₃ mm	d ₅ mm	d ₂ mm	
4	0.7	3.1	3.3	48	7.7	9.5	4.1	6	2
5	0.8	4	4.2	54	9.6	11.8	5.1	6	2
6	1	4.75	5	62	12	14.7	6.2	8	2
8	1.25	6.5	6.75	74	15	18.4	8.2	10	2
10	1.5	8.25	8.5	80	19.4	23.6	10.3	12	2
12	1.75	9.95	10.25	90	22.7	27.3	12.3	14	2
14	2	11.6	12	102	27.9	33.1	14.4	16	2
16	2	13.6	14	102	31.9	37.5	16.4	18	2

ID	ID
* 153430	* 153442
* 151305	* 151306
* 150933	* 151776
* 153431	* 150588
* 153432	* 150589
* 153433	* 150927
* 153434	* 153443
* 153435	* 151324

Ø D ₁ M	P mm	d ₁ mm	d ₁₀ mm	l ₁₁ mm	l ₂ mm	l ₃ mm	d ₅ mm	d ₂ mm	
6	1	4.75	5	62	15	17.7	6.2	8	2
8	1.25	6.5	6.75	74	20	23.4	8.2	10	2
10	1.5	8.25	8.5	80	23.9	28.1	10.3	12	2
12	1.75	9.95	10.25	90	29.7	34.3	12.3	14	2
14	2	11.6	12	102	35.9	41.1	14.4	16	2
16	2	13.6	14	102	39.9	45.5	16.4	18	2

ID	ID
● 153451	● 153467
● 153452	● 153468
* 153453	* 153469
* 153454	* 153470
* 153455	* 153471
* 153456	* 153472

BGF

BGF6865



BGF6865VS



BGF6866



BGF6866VS

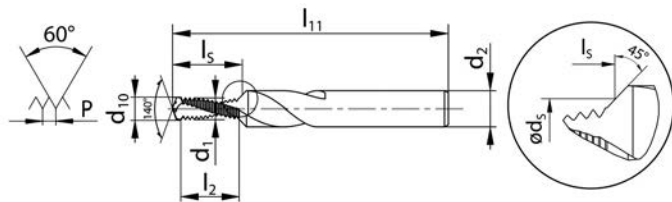

BGF6865

BGF6865VS

BGF6866

BGF6866VS

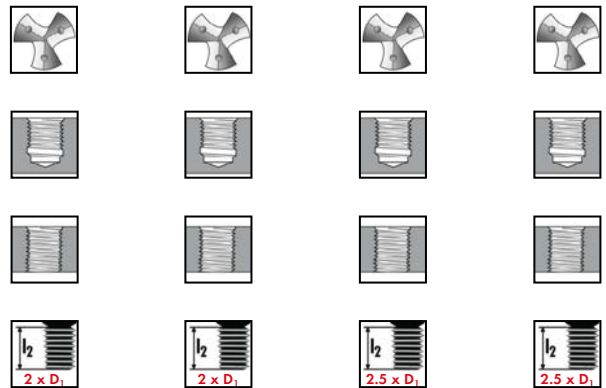

$\emptyset D_1$ M	P mm	d_1 mm	d_{10} mm	l_{11} mm	l_2 mm	l_3 mm	d_2 mm	d_3 mm	d_4 mm	
6	1	4.75	5	62	12	14.7	6.2	8	3	
8	1.25	6.5	6.75	74	15	18.4	8.2	10	3	
10	1.5	8.25	8.5	80	19.4	23.6	10.3	12	3	
12	1.75	9.95	10.25	90	22.7	27.3	12.3	14	3	
14	2	11.6	12	102	27.9	33.1	14.4	16	3	
16	2	13.6	14	102	31.9	37.5	16.4	18	3	

ID	ID
* 153577	* 153589
* 153578	* 153590
* 153579	* 153591
* 153580	* 153592
* 153581	* 153593
* 153582	* 153594

$\emptyset D_1$ M	P mm	d_1 mm	d_{10} mm	l_{11} mm	l_2 mm	l_3 mm	d_2 mm	d_3 mm	d_4 mm	
6	1	4.75	5	62	15	17.7	6.2	8	3	
8	1.25	6.5	6.75	74	20	23.4	8.2	10	3	
10	1.5	8.25	8.5	80	23.9	28.1	10.3	12	3	
12	1.75	9.95	10.25	90	29.7	34.3	12.3	14	3	
14	2	11.6	12	102	35.9	41.1	14.4	16	3	
16	2	13.6	14	102	39.9	45.5	16.4	18	3	

ID	ID
* 153601	* 153613
* 153602	* 153614
* 153603	* 153615
* 153604	* 153616
* 153605	* 153617
* 153606	* 153618

BGF

BGF6760



BGF6760VS



BGF6765



BGF6765VS

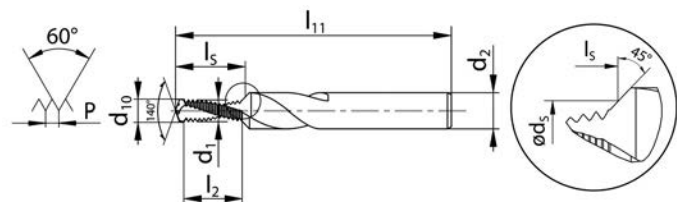

BGF6760

BGF6760VS

BGF6765

BGF6765VS

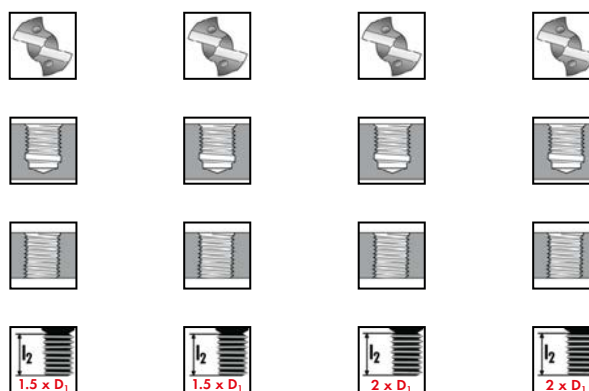

Ø D ₁ MF	P mm	d ₁ mm	d ₁₀ mm	l ₁₁ mm	l ₂ mm	l ₁ mm	d ₁ mm	d ₂ mm	
6	0.75	5	5.25	62	9	11.4	6.2	8	2
8	1	6.75	7	74	12	15	8.2	10	2
10	1	8.75	9	80	15	18.5	10.3	12	2
12	1	10.7	11	90	18	21.9	12.3	14	2
12	1.5	10.2	10.5	90	17.9	22.5	12.3	14	2
14	1.5	12.1	12.5	102	20.9	26	14.4	16	2
16	1.5	14.1	14.5	102	23.9	29.4	16.4	18	2

ID













ID

Ø D ₁ MF	P mm	d ₁ mm	d ₁₀ mm	l ₁₁ mm	l ₂ mm	l ₁ mm	d ₁ mm	d ₂ mm	
6	0.75	5	5.25	62	12	14.4	6.2	8	2
8	1	6.75	7	74	16	19	8.2	10	2
10	1	8.75	9	80	20	23.5	10.3	12	2
12	1	10.7	11	90	24	27.9	12.3	14	2
12	1.5	10.2	10.5	90	23.9	28.5	12.3	14	2
14	1.5	12.1	12.5	102	26.9	32	14.4	16	2

ID

ID

Directorio - Tampones de roscas y calibres anillos de roscas
Directory - Screw thread plug and ring gauges

Tipo Type		D5701-1	D5701-2	D5703		D5720	D5722	D5725
Características Characteristics								
								
M 6H / 6g ISO DIN 13		138	138	138				
M 6G / 6e ISO DIN 13				138				
M 6H / 6g LH ISO DIN 13				138				
MF 6H / 6g ISO DIN 13		140-141	141	140-141				
MF 6G / 6e ISO DIN 13				140				
MF 6H / 6g LH ISO DIN 13				140				
UNC ASME B1.1		144		144				
UNF ASME B1.1		145		145				
UNEF ASME B1.1				145				
NPT ASME B1.20.1						147		
NPTF ANSI B1.20.3						147		
G (BSP) DIN EN ISO 228		146	146	146				
PG DIN 40430								146
EG M ISO DIN 8140				148				
EG UNC NASM 33537				148				
EG UNF NASM 33537				148				

D5704	D5714	D5721	D5723
139	139		
139	139		
139			
142-143	142-143		
142			
144	144		
145	145		
145	145		
		147	
		147	
146	146		
146			

Pictogramas - Pictographs

	"Pasa" "Go"
	"No pasa" "No-Go"
	"Pasa" / "No pasa" "Go" / "No-Go"
	Tolerancia 6H, "Pasa" Tolerance 6H, "Go"
	Tolerancia 6G, "Pasa" / "No pasa" Tolerance 6G, "Go" / "No-Go"
	Tolerancia 6g, "No pasa" Tolerance 6g, "No-Go"
	Rosca izquierda Left-hand thread

Calibres de entrega inmediata sin certificado de control.

Sobre pedido, los calibres pueden ser entregados con certificado en breve, servicio de pago.

Para nuevos calibres de roscar / Incertidumbre de medida U95.

Al certificar, los calibres son marcados con el n° de identificación de los certificados correspondientes.

Thread gauges available from stock without test certificate.









However, all gauges can be delivered in short time with test certificate on request, price for the certificate on request.

For new ordered thread gauges / Measuring uncertainty U95.

All "certified" thread gauges will be marked with the identity number of the corresponding test certificate.

















**ISO DIN 13
DIN ISO 1502**





		D5701-1	D5701-2	D5703	D5703 LH	D5703		
D5701-1 M1 - M1.4 =  D5703 M1 - M1.4 = 								
					 			
Ø d ₁ M	P mm	ID	ID	ID	ID	ID		
1	0.25			● 100242				
1.1	0.25			● 100243				
1.2	0.25			● 100244				
1.4	0.3			● 100245				
1.6	0.35			● 100246				
1.7	0.35			● 100247				
1.8	0.35			● 100248				
2	0.4			● 100278	● 105159	● 104982		
2.2	0.45			● 100280				
2.3	0.4			● 100281				
2.5	0.45			● 100283	● 105160	● 104979		
2.6	0.45			● 100285				
3	0.5			● 100310	● 104964	● 104976		
3.5	0.6			● 100312		● 104977		
4	0.7			● 100333	● 104966	● 104978		
4.5	0.75	* 100114						
5	0.8			● 100348	● 104967	● 104980		
6	1			● 100363	● 104968	● 104981		
7	1			● 100369	* 110186			
8	1.25			● 100373	● 104969	● 104983		
9	1.25			● 100375				
10	1.5			● 100253	● 104970	● 104984		
11	1.5			* 100256				
12	1.75			● 100261	● 104971	● 104985		
14	2	* 100045		● 100266		● 104986		
16	2			● 100271	● 104973	● 104987		
18	2.5	* 100055		● 100276		* 104988		
20	2.5	* 100068		● 100289	● 104975	● 104989		
22	2.5	* 100072		● 100293	* 110178			
24	3	* 100076		● 100297	● 110179			
27	3			● 100305				
30	3.5			● 100316				
33	3.5	* 100101		● 100322				
36	4	* 100107		● 100328				
39	4	* 100109		● 100330				
42	4.5		● 142843					
45	4.5		● 142844					
48	5		● 142845					
52	5		● 142846					
56	5.5		● 142847					





ISO DIN 13
DIN ISO 1502

		D5704	D5704 LH	D5704	D5714	D5714	
D5704	M1 - M1.4 = 6h						
D5714	M1 - M1.4 = 6h						
		6g	6g LH	6e	6g	6e	
$\emptyset d_1$ M	P mm	ID	ID	ID	ID	ID	
1	0.25	● 100480			● 110419		
1.2	0.25	● 100481			● 110420		
1.4	0.3	● 100482			● 110421		
1.6	0.35	● 100483			● 110422		
1.7	0.35	● 100484			● 111439		
1.8	0.35	● 100485			● 110423		
2	0.4	● 100515	● 105006		● 100734		
2.2	0.45	● 100517			● 100735		
2.3	0.4	● 100518			● 100736		
2.5	0.45	● 100520			● 100737		
2.6	0.45	● 100522			● 100738		
3	0.5	● 100547	● 105001		● 100763		
3.5	0.6	● 100549	● 110302	* 110301	● 100765	* 142836	
4	0.7	● 100570	● 105003		● 100774		
5	0.8	● 100585	● 105004	* 104993	● 100778	* 143406	
6	1	● 100600	● 105005	* 104994	● 100781	* 135556	
7	1	● 100605		* 104995	● 100783		
8	1.25	● 100611	● 105007		● 100786		
9	1.25	● 100610			● 100788		
10	1.5	● 100490	● 105008		● 100711	* 142842	
11	1.50				* 100713		
12	1.75	● 100498	● 105009		● 100718		
14	2	● 100503	● 105010		● 100723		
16	2	● 100508	● 105011	* 105000	● 100728		
18	2.5	● 100513	● 105012		● 100733		
20	2.5	● 100526	● 105013		● 100742		
22	2.5	● 100530	● 110298		● 100746		
24	3	● 100534			● 100750		
27	3	● 100542			● 100758		
30	3.5	● 100553			● 100769		
33	3.5	* 100559			* 100770		
39	4				* 110440		
45	4.5				* 110448		
56	5.5	* 100595			* 110461		

		D5701-1	D5703	D5703 LH	D5703		
							
				 			
Ø d ₁ MF	P mm	ID	ID	ID	ID		
2.5	0.35		● 100282				
3	0.35		● 100309				
4	0.35		● 100331				
4	0.5		● 100332				
5	0.5		● 100347	● 105016	● 105045		
6	0.5	* 100140	● 100361	● 110184			
6	0.75		● 100362		● 105046		
7	0.5		● 100367				
7	0.75	* 100147	● 100368				
8	0.5	* 100149	● 100370				
8	0.75		● 100371	● 105018	● 105047		
8	1	* 100151	● 100372	● 105019	● 105048		
9	1		● 100374				
10	0.5		● 100249				
10	0.75		● 100250				
10	1		● 100251	● 105020	● 105049		
10	1.25	* 100031	● 100252				
11	1	* 100034	● 100255				
12	0.75	* 100036	● 100257				
12	1		● 100258	● 105021	● 105050		
12	1.25		● 100259				
12	1.5		● 100260	● 105022			
14	1		● 100263	● 110171			
14	1.25		● 100264				
14	1.5		● 100265	● 105023	● 105052		
15	1		● 100267				
15	1.5		● 100268				
16	1		● 100269	● 110172			
16	1.5		● 100270	● 105024	● 105053		
17	1		● 100272				
18	1		● 100273				
18	1.5		● 100274	● 105025	● 105054		
18	2	* 100054	● 100275				
20	1	* 100065	● 100286				
20	1.5		● 100287	● 105026			
20	2	* 100067	● 100288		* 110176		
22	1		● 100290				
22	1.5		● 100291	● 110177			
22	2		● 100292				
24	1		● 100294				
24	1.5		● 100295				
24	2		● 100296				

		D5701-1	D5701-2	D5703				
								
								
$\varnothing d_1$ MF	P mm	ID	ID	ID				
25	1			● 100298				
25	1.5			● 100299				
25	2			● 100300				
26	1			● 100301				
26	1.5	* 100081		● 100302				
27	1.5	* 100082		● 100303				
27	2	* 100083		● 100304				
28	1			● 100306				
28	1.5	* 100086		● 100307				
28	2	* 100087		● 100308				
30	1	* 100092		● 100313				
30	1.5			● 100314				
30	2			● 100315				
32	1			● 100317				
32	1.5			● 100318				
32	2			● 100319				
33	1.5			● 100320				
33	2			● 100321				
35	1.5			● 100323				
36	1.5			● 100325				
36	2			● 100326				
36	3			● 100327				
38	1.5	* 100108		● 100329				
40	1.5			● 100336				
40	2			● 100337				
42	1.5	● 100117	● 142848					
42	2	● 100118	● 142849					
45	1.5	● 100120	● 110127					
45	2	● 100121	● 142851					
48	1.5	● 100123	● 123180					
48	2	● 100124	● 142853					
50	1.5	● 100128	● 142854					
50	2	● 100129	● 142855					
52	1.5	● 100130	● 123428					
52	2	● 100131	● 142857					
55	1.5		● 123468					
55	2	● 100134	● 142859					
56	1.5	● 100135	● 142860					
56	2	● 100136	● 142861					
58	1.5	● 100138	● 142862					
58	2	● 100139	● 142863					
60	1.5	● 100143	● 142864					
60	2	● 100144	● 142865					





		D5704	D5704 LH	D5714			
							
		6g	6g	LH	6g		
$\varnothing d_1$ MF	P mm	ID	ID	ID			
2.5	0.35	● 100519		● 110427			
3	0.35	● 100546		● 100762			
3.5	0.35	● 100548		● 100764			
4	0.35	● 100568		● 100772			
4	0.5	● 100569		● 100773			
4.5	0.5	● 100571		● 100775			
5	0.5	● 100584	● 105057	● 100777			
6	0.5	● 100598	● 110307	● 100779			
6	0.75	● 100599	● 105058	● 100780			
7	0.5	● 100603		● 110467			
7	0.75	● 100604		● 100782			
8	0.5	● 100606					
8	0.75	● 100607	* 105059	● 100784			
8	1	● 100608	● 105060	● 100785			
9	1	● 100609		● 100787			
10	0.5	● 100486		● 100707			
10	0.75	● 100487		● 100708			
10	1	● 100488	● 105061	● 100709			
10	1.25	● 100489		● 100710			
11	1	● 100492		● 100712			
12	0.75	● 100494		● 100714			
12	1	● 100495	● 105062	● 100715			
12	1.25	● 100496		● 100716			
12	1.5	● 100497	● 105063	● 100717			
13	1	● 100499		● 100719			
14	1	● 100500	● 110290	● 100720			
14	1.25	● 100501		● 100721			
14	1.5	● 100502	● 105064	● 100722			
15	1	● 100504		● 100724			
15	1.5	● 100505		● 100725			
16	1	● 100506	● 110292	● 100726			
16	1.5	● 100507	● 105065	● 100727			
17	1	● 100509		● 100729			
18	1	● 100510		● 100730			
18	1.5	● 100511	● 105066	● 100731			
20	1	● 100523	● 110295	● 100739			
20	1.5	● 100524	● 105067	● 100740			
20	2	● 100525		● 100741			
22	1	● 100527		● 100743			
22	1.5	● 100528		● 100744			
22	2	● 100529		● 100745			
24	1	● 100531		● 100747			
24	1.5	● 100532		● 100748			
24	2	● 100533					

		D5704	D5714			
						
		6g	6g			
$\varnothing d_1$ MF	P mm	ID	ID			
25	1	● 100535				
25	1.5	● 100536				
26	1	● 100538				
26	1.5	● 100539				
27	1.5	● 100540				
27	2	● 100541	* 100757			
28	1	● 100543				
28	1.5	● 100544	* 100760			
30	1	● 100550				
30	1.5	● 100551				
30	2	● 100552				
32	1	● 100554				
32	1.5	● 100555				
32	2	● 100556				
33	1.5	● 100557				
33	2	● 100558	* 110433			
35	1.5	● 100560				
36	1.5	● 100562				
36	2	● 100563				
36	3	● 100564				
38	1.5	● 100566				
40	1.5	● 100573				
42	1.5	● 100575				
42	2	● 100576				
45	1.5	● 100578				
45	2	● 100579				
48	1.5	● 100581	* 110449			
48	2	● 100582				
50	1.5	● 100586				
50	2	● 100587	* 110453			
52	1.5		* 110454			
52	2	● 100589				
55	1.5	● 100591				
55	2	● 100592	* 110458			
56	1.5	● 100593	* 110459			
56	2		* 110460			
58	1.5	● 100596				
58	2	● 100597	* 110463			
60	1.5	● 100601				
60	2	● 105014				

UNC ASME B1.1 ANSI / ASME B1.2













		D5701-1	D5703	D5704	D5714		
		2B	2B	2A	2A		
Ø" d ₁ UNC	P TPI	ID	ID	ID	ID		
1	64		● 100408	● 110347	● 110473		
2	56		● 100414	● 110353	● 110479		
3	48		● 100416				
4	40	* 110080	● 110224	● 110357	● 110483		
5	40		● 100420				
6	32	* 110084	● 100423	● 110361	● 110487		
8	32		● 100426	● 110364	● 110490		
10	24	* 110074	● 100412	● 110351	● 110477		
12	24		● 100413				
1/4	20		● 100410	● 110349	● 110475		
5/16	18	* 110082	● 100421	● 110359	● 110485		
3/8	16	* 110079	● 100418	● 110356	● 110482		
7/16	14	* 110085	● 100424	● 110362	● 110488		
1/2	13	* 110071	● 100409	● 110348	● 110474		
9/16	12		● 100427	● 110365	* 110491		
5/8	11		● 100422	● 110360			
3/4	10	* 110078	● 100417	● 110355	* 110481		
7/8	9		● 100425	● 110363	* 110489		
1	8	* 110073	● 100411	● 110350	* 110476		
1 1/8	7	* 110068	● 100405	* 110345	* 110471		
1 1/4	7	* 110067	● 100404	* 110344	* 110470		
1 3/8	6	* 110069	● 100407	* 110346	* 110472		
1 1/2	6	* 110066	● 100403	* 110343	* 110469		

UNF, UNEF ASME B1.1 ANSI / ASME B1.2

		D5701-1	D5703	D5704	D5714		
							
		2B	2B	2A	2A		
Ø" d ₁ UNF	P TPI	ID	ID	ID	ID		
0	80		● 110246				
1	72		● 110251	● 110383	● 110508		
2	64		● 110256	● 110389	● 110514		
3	56		● 110257	● 110390	● 110515		
4	48		● 110260	● 110393	● 110518		
5	44	* 110116					
6	40		● 110264				
8	36	* 110122	● 110267				
10	32		● 110254	● 110387	● 110512		
12	28		● 110255	● 110388	● 110513		
1/4	28	* 110107	● 110006	● 110385	● 110510		
5/16	24	* 110117	● 110262	● 110395	● 110520		
3/8	24	* 110114	● 110259	● 110392	● 110517		
7/16	20	* 110120	● 110265	● 110398	● 111440		
1/2	20	* 110106	● 110252	● 110384	● 110509		
9/16	18		● 110268	● 110401			
5/8	18		● 110263	● 110396			
3/4	16		● 110258	● 110391			
7/8	14		● 110266	● 110399			
1	12		● 128646	● 110386			
1 1/8	12	* 110103	● 110249	● 110381			
1 1/4	12		● 110248	● 110380	* 110505		
1 3/8	12	* 110104	● 110250		* 110507		
1 1/2	12		● 110247	● 110379			
Ø" d ₁ UNEF	P TPI	ID	ID	ID			
12	32		● 110238				
1/4	32		● 110236	● 110368	● 110493		
5/16	32		● 110241	● 110373	● 110498		
3/8	32		● 110240	● 110372	● 110497		
7/16	28		● 110243	● 110375	● 110500		
1/2	28		● 110235	● 110367	● 110492		
9/16	24		● 110245	● 110377	● 110502		
5/8	24		● 110242	● 110374	● 110499		
3/4	20		● 110239	● 110371	● 110496		
7/8	20		● 110244		* 110501		
1	20		● 110253	● 110369	● 110494		



G DIN EN ISO 228 (BSP)
DIN EN ISO 228-2

PG DIN 40430
DIN 40431

		D5701-1	D5701-2	D5703	D5704	D5714	D5725
							
							
\varnothing " d ₁ G	P TPI	ID	ID	ID	ID	ID	ID
1/8	28	* 110044		● 110009	● 110277	● 110408	
1/4	19			● 110003	● 110276	● 110407	
3/8	19	* 110052		● 110162	● 110284	● 110415	
1/2	14			● 110001	● 110275	● 110406	
5/8	14			● 110164	● 110286	● 110417	
3/4	14			● 110161	● 110283	● 110414	
7/8	14	* 110054		● 110165			
1	11			● 110156	● 110278	● 110409	
1 1/8	11			● 110154		* 110404	
1 1/4	11	● 110041	● 119459		● 110272		
1 1/2	11	● 110040	● 119429		● 110271		
1 3/4	11	● 110043	● 142868		● 110274	* 110405	
2	11	● 110050	● 110126		● 110282		
2 1/4	11					* 110411	
2 1/2	11		* 110125				
2 3/4	11					* 110412	
\varnothing d ₁ PG	P TPI	ID				ID	ID
7	20					● 110216	
9	18					● 110217	
11	18					● 110205	
13.5	18					● 110209	
16	18				* 110330	● 110210	
21	16				* 110331	● 110211	
29	16					● 110212	

NPT ASME B1.20.1 ASME B1.20.1

NPTF ANSI B1.20.3 ASA B2.2





		D5720	D5721				
							
							
$\varnothing'' d_1$ NPT	P TPI	ID	ID				
1/16	27	● 110190	● 110313				
1/8	27	● 110193	● 110316				
1/4	18	● 110192	● 110315				
3/8	18	● 110197	● 110320				
1/2	14	● 110191	● 110314				
3/4	14	● 110196	● 110319				
1	11.5	● 110194	● 110317				
1 1/4	11.5	● 110189	● 110312				
1 1/2	11.5	● 110188	● 110311				
2	11.5	● 110195	● 110318				
$\varnothing'' d_1$ NPTF	P TPI	ID	ID				
1/8	27	● 110201					
1/4	18	● 110200	* 110323				
3/8	18	● 110204					
1/2	14	● 110199	* 110322				
3/4	14	● 110203	* 110326				
1	11.5	● 110202	* 110325				

EG M

ISO DIN 8140-2
DIN ISO 1502

EG UNC, EG UNF

NASM 33537
~ ISO 1502

		D5703	D5703	D5703				
								
								
$\varnothing d_1$ EG M	P mm	ID						
2.5	0.45	● 110132						
3	0.5	● 110133						
4	0.7	● 110134						
5	0.8	● 110135						
6	1	● 110136						
8	1.25	● 110137						
10	1.5	● 110128						
12	1.75	● 110129						
16	2	● 110131						
$\varnothing'' d_1$ EG UNC	P TPI	ID						
4	40	● 170252						
6	32	● 170253						
8	32	● 170254						
10	24	● 170255						
1/4	20	● 170256						
5/16	18	● 170257						
3/8	16	● 170258						
$\varnothing'' d_1$ EG UNF	P TPI	ID						
6	40	● 170259						
8	36	● 170260						
10	32	● 161020						
1/4	28	● 151790						
5/16	24	● 170261						
3/8	24	● 160134						

MUCHO MAS A DESCUBRIR

EN EL NUEVO CATÁLOGO PARA
HERRAMIENTAS DE ROSCADO,
DISPONIBLE A FINAL 2020



MUCH MORE TO DISCOVER

IN OUR NEW THREADING TOOL CATALOGUE
AVAILABLE AT THE END OF 2020



CALIBRES PARA ROSCAS NANO — NANO THREAD GAUGES

CALIBRES TAMPÓN — THREAD PLUG GAUGES

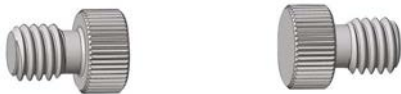

METROLOGÍA — METROLOGY

< 2.74 mm



GO



PRODUCCIÓN — PRODUCTION

GO



NO-GO



UTILIZACIÓN

El hecho de que el giro inicial de la rosca y la punta del calibrador hayan sido aplanados asegura que la herramienta se enganche óptimamente en la rosca, lo cual es esencial para garantizar una medición correcta. Eso permite al calibre de comprobar la rosca a su máxima profundidad.

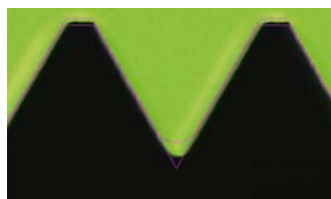

CONTROL DE PERFIL

Nuestra experiencia en el campo de la rectificación nos asegura un control perfecto de las tolerancias, de la forma del perfil y la calidad superficial.



ANILLOS DE CONTROL NO PASA

El corte en el diámetro exterior de nuestros medidores de anillo NO-GO asegura que los lados del tornillo se pueden comprobar óptimamente, eliminando el riesgo de cualquier inspección incorrecta causada por un bloqueo en el diámetro exterior del medidor.



SISTEMA MODULAR

Un tornillo de acoplamiento permite conectar el calibre GO a la sección NO-GO según sea necesario. La caja rígida protege los medidores durante el transporte. Su interior moldeado mantiene el producto limpio y lo protege de los impactos.

CONTRA CALIBRES — PLUG CHECK GAUGES

El contra calibre NO-GO es el salvaguardia para el uso del calibre anillo.

The NO-GO plug check gauge is the foolproofing device for the new ring gauge.

El contra calibre GO sirve a qualificar el calibre anillo.

The GO plug check gauge is used to check the quality of your ring gauge.



En "M" el testimonio de desgaste extenderá la vida útil del calibre anillo hasta el límite de tolerancia dado por la norma.

The master plug gauge WEAR will extend the service life of your ring gauge up to a certain tolerance limit.

UTILISATION

The fact that the initial turn of the screw thread and also the tip of the gauge have been ground flat ensures that the tool engages optimally in the thread, which is essential for ensuring a correct measurement. This enables the gauge to check the thread at its maximum depth.

PROFILE CONTROL

Our expertise in the field of rectification ensures we have perfect control of tolerances for the shape of the profile and for surface textures.

NO-GO RING GAUGE

The cut-away on the exterior diameter of our NO-GO ring gauges ensures the sides of the screw can be optimally checked, eliminating the risk of any incorrect inspection caused by a blockage on the exterior diameter of the gauge.

MODULAR SYSTEM

A coupling screw enables the GO gauge to be connected to the NO-GO section as required. The rigid box protects the gauges during transportation. Its moulded interior keeps the product clean and protects it from impacts.

SCS CERTIFICADO DE MEDICIÓN

Un certificado es la confirmación por escrito de la calidad del equipo metrológico de una empresa. DC NANO TOOLS SA (acreditación SCS 0143), miembro del Grupo DC SWISS, puede inspeccionar y calibrar medidores de rosca para usted de acuerdo con la norma internacional ISO 17025. Ese servicio de pago está disponible para diámetros de flanco de 0.1 a 3.0 mm, y diámetros externos de 0.1 a 3.5 mm.

La totalidad de los calibres tienen certificado SCS.

ISO 17025/2005 accredited © DC Nano Tools SA

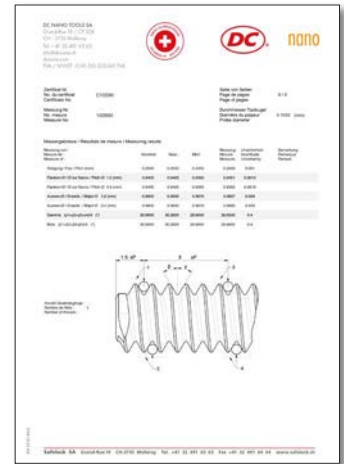

SCS MEASUREMENT CERTIFICATE

A certificate is written confirmation of the quality of a company's metrological equipment. DC NANO TOOLS SA (SCS accreditation 0143), a member of the DC SWISS Group, can inspect and calibrate thread gauges for you in accordance with the ISO 17025 international standard.

This chargeable service is available for pitch diameters of 0.1 to 3.0 mm and external diameters of 0.1 to 3.5 mm.

All plug thread gauges are SCS certified.

ISO 17025/2005 accredited © DC NANO TOOLS SA

DESCARGUE SU CONFIRMACIÓN DE CUMPLIMIENTO

Ahora puede acceder a su confirmación de conformidad en cualquier momento, en cualquier lugar desde su teléfono. Simplemente escanee el código QR en la tarjeta acompañando la caja y descargue el archivo pdf asociado.

La confirmación de conformidad que acompaña a cada caja confirma que la calidad ha seguido escrupulosamente el proceso de seguimiento posterior a la producción.

DC SWISS SA quality control

DOWNLOAD YOUR CONFIRMATION OF COMPLIANCE

You can now access your confirmation of compliance any time, at any place on your phone. Simply scan the QR code on the card inside the box and download the associated pdf file.

The confirmation of compliance accompanying each box confirms that the factory has scrupulously followed the post-production monitoring process.

DC SWISS SA quality control

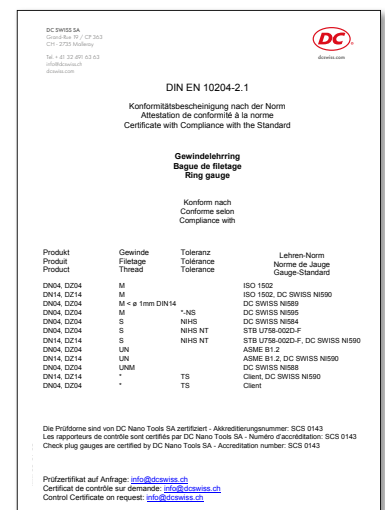

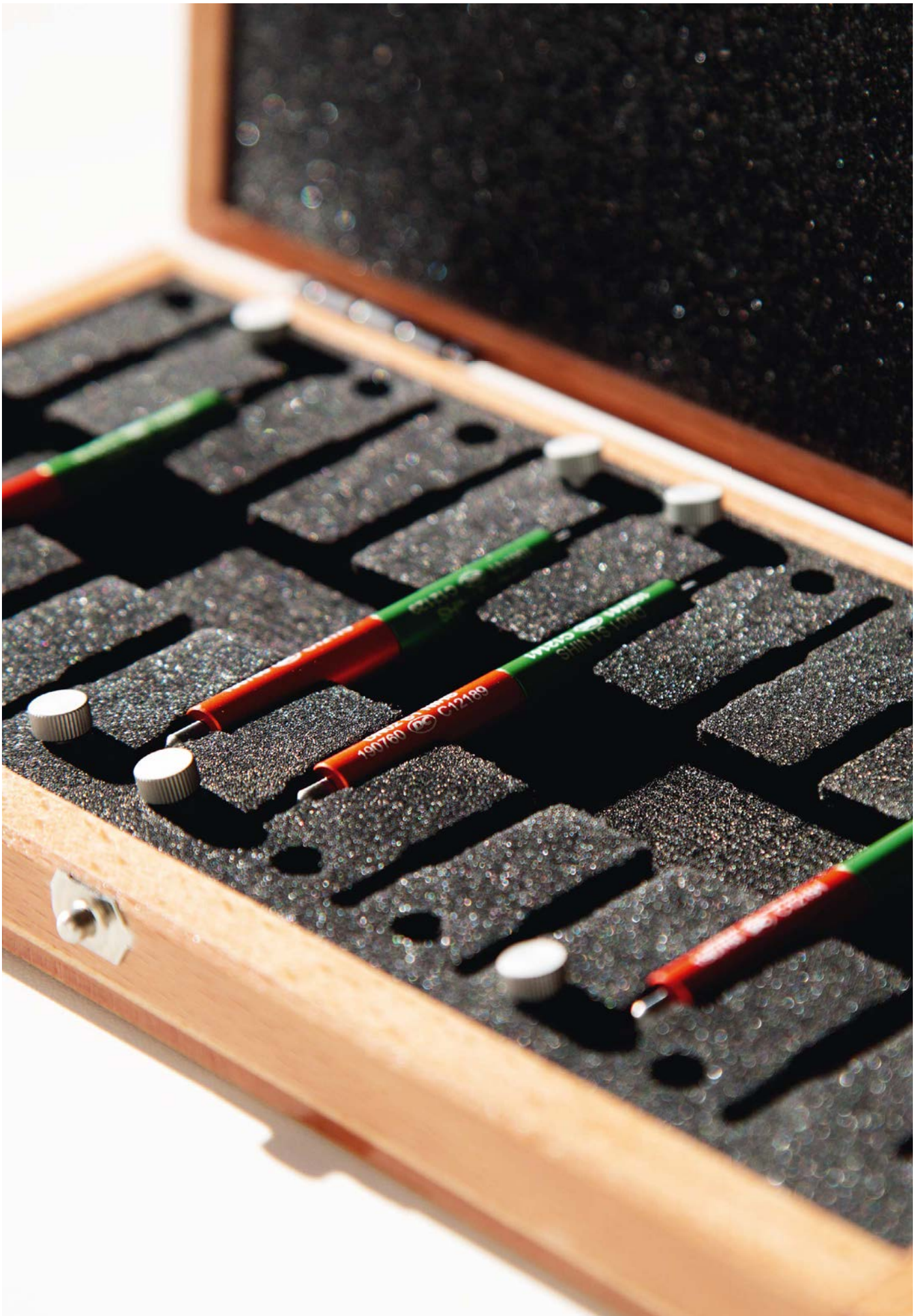

JUEGOS DISPONIBLES — AVAILABLE SETS



**CALIBRES TAMPONES Y ANILLOS DN
THREAD PLUG GAUGES & RING GAUGES DN**

JUEGO UNITARIO — SINGLE SET



**CALIBRES ANILLOS DZ
THREAD RING GAUGES DZ**

JUEGO UNITARIO — SINGLE SET



**CALIBRES TAMPONES / ANILLOS DN
PLUG GAUGES DN / RING GAUGES DN**

**JUEGOS DE 10 O 20 PIEZAS
SET OF 10 OR 20 ITEMS**

*Para cada juego, podeis seleccionar
el numero exacto de calibres GO/NO GO.*

Contactarnos para sus composiciones personal.

You can select the exact number of
GO / NO-GO thread gauges for each set.

Contact us for any other set compositions.

dcswiss.com / sales@dcswiss.ch / +41 32 491 63 63

PEDIR CALIBRES NANO — NANO THREAD GAUGES ORDER

TIPO DE HERRAMIENTA — TOOL TYPE







CARACTERÍSTICAS — CHARACTERISTICS

DIMENSIÓN DIMENSION	TOLERANCIA TOLERANCE	NORMA NORM	CANTIDAD QUANTITY	ESPECIALES SPECIFICS





OBSERVACIONES — REMARKS



INFORMACIÓN DE ENVÍO — DELIVERY INFORMATION

Por favor, dirija su pedido.
Thank you for initialing your order.



Directorio - Calibres de control NANO para micromecánica y relojería
Directory - Thread gauges NANO for micromechanics and watchmaking

		Calibres tampon Thread plug gauges			Calibres anillos Thread ring gauges				Contra calibres Plug check gauges			
Tipo Type		DN01 GO	DN01 GO	DN02 NO-GO	DZ04 GO	DZ14 NO-GO	DN04 GO	DN14 NO-GO	RN05-1 GO	RN15-1 GO	RN05-2 NO-GO	RN15-2 NO-GO
Características Characteristics												
M 4H / 5h	ISO DIN 14 ISO DIN 13		158	158	164	164	169	169	174	174	179	179
M 6H / 6g	ISO DIN 13		158	158	164	164	169	169	174	174	179	179
M 5H / 6h	ISO DIN 13		158	158	164	164	169	169	174	174	179	179
MF 4H / 4h	ISO DIN 13		159	159	165	165	170	170				
MF 6H / 6g	ISO DIN 13		159	159	165	165	170	170	175	175	180	180
MF 6h	ISO DIN 13				165	165	170	170	175	175	180	180
UNC 2B / 2A	ASME B1.1		160	160	166	166	171	171	176	176	181	181
UNC 3B / 3A	ASME B1.1		160	160	166	166	171	171	176	176	181	181
UNF 2B / 2A	ASME B1.1		160	160	166	166	171	171	176	176	181	181
UNF 3B / 3A	ASME B1.1		160	160	166	166	171	171	176	176	181	181
S NIHS 3G	NIHS	161										
S NIHS 4H	NIHS		161									
S NIHS 4H / 3G	NIHS			161								
S NIHS	NIHS				167	167	172	172	177	177	182	182
S NIHS NT	NIHS		162	162	167	167	172	172	177	177	182	182
SF NIHS 3G	NIHS	163										
SF NIHS 4H	NIHS		163									
SF NIHS 4H / 3G	NIHS			163								
SF NIHS	NIHS				168	168	173	173	178	178	183	183
SF NIHS NT	NIHS								178	178	183	183
SL	SL 15-01		163	163								

	Calibres de desgaste WEAR Master plug gauges WEAR		Patrones Calibration thread plug gauges
Tipo Type	RN05-3 WEAR	RN15-3 WEAR	EN00
Características Characteristics			
			
M 4H / 5h	ISO DIN 14 ISO DIN 13		
M 6H / 6g	ISO DIN 14 ISO DIN 13	184	184
M 5H / 6h	ISO DIN 13	184	184
MF 4H / 4h	ISO DIN 13		
MF 6H / 6g	ISO DIN 13	185	185
MF 6h	ISO DIN 13	185	185
S NIHS	NIHS		186

Pictogramas - Pictographs



"Pasa"

"Go"



"No pasa"

"No-Go"



Tolerancia 6H, "Pasa"

Tolerance 6H, "Go"



Tolerancia 6g, "No pasa"

Tolerance 6g, "No-Go"



No debe superarse la longitud máxima de medición l2

Max. measuring length l2 must not be exceeded



Phynox KL

Phynox KL



Sobre pedido, todos los calibres de roscas son igualmente a la entrega para roscado a izquierda

All gauges can be supplied with a left-hand thread upon request

Usar — Use

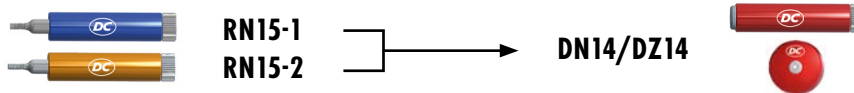
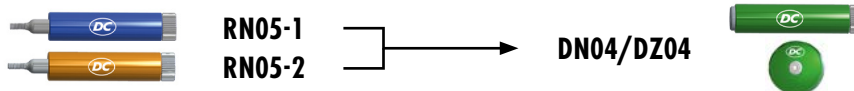

nano

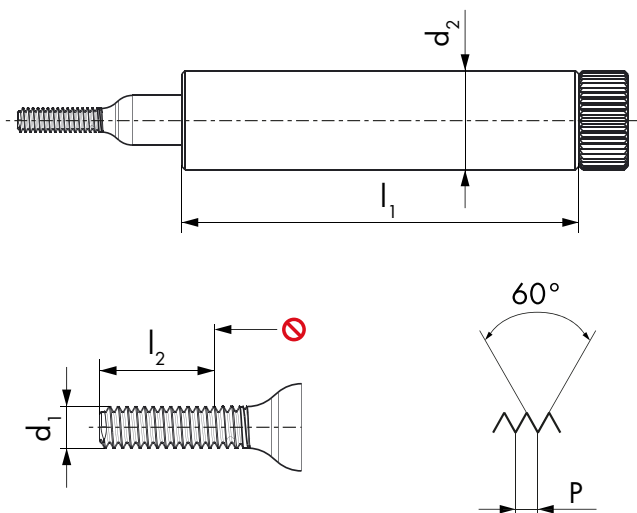

DN01 GO DN02 NO-GO DN01 GO DN02 NO-GO



$\emptyset d_1$ M	P mm	l_1 mm	l_2 GO mm	d_2	ID	ID	ID	ID
0.3	0.08	24	0.9	6	● 192778	● 192786		
0.35	0.09	24	1.05	6	● 192779	● 192787		
0.4	0.1	24	1.2	6	● 192780	● 192788		
0.5	0.125	24	1.5	6	● 192781	● 192789		
0.6	0.15	24	1.8	6	● 192782	● 192790		
0.7	0.175	24	2.1	6	● 192783	● 192791		
0.8	0.2	24	2.4	6	● 192784	● 192792		
0.9	0.225	24	2.7	6	● 192785	● 192793		
1	0.25	24	3	6	● 191113	● 191127	● 191421 ¹	● 191424 ¹
1.2	0.25	24	3.6	6	● 191114	● 191128	● 191422 ¹	● 191425 ¹
1.4	0.3	24	4.2	6	● 191115	● 191129	● 191423 ¹	● 191426 ¹
1.6	0.35	24	4.5	6			● 191427	● 191433
1.8	0.35	24	4.5	6			● 191428	● 191434
2	0.4	24	4.5	6			● 191429	● 191435
2.3	0.4	24	4.5	6			● 191430	● 191436
2.5	0.45	24	4.5	6			● 191431	● 191437
2.6	0.45	24	4.5	6			● 191432	● 191438

¹ Tol. 5H



All nano thread plug gauges are SCS-certified and the paid certificate is available on request.

nano

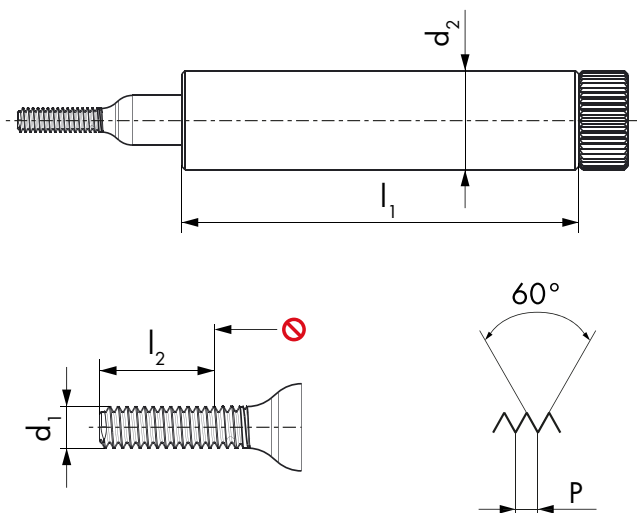

DN01 GO

DN02 NO-GO

DN01 GO

DN02 NO-GO



$\varnothing d_1$ MF	P mm	l_1 mm	l_2 GO mm	d_2	ID	ID	ID	ID
1.4	0.2	24	4.2	6	● 191116	● 191130		
1.6	0.2	24	3	6	● 191117	● 191131		
1.8	0.2	24	3	6	● 191118	● 191132		
2	0.2	24	3	6	● 191119	● 191133		
2	0.25	24	3	6	● 192794	● 192797		
2.2	0.2	24	3	6	● 191120	● 191134		
2.2	0.25	24	3	6	● 191121	● 191135		
2.3	0.2	24	3	6	● 191122	● 191136		
2.3	0.25	24	3	6	● 191123	● 191137		
2.5	0.2	24	3	6	● 191124	● 191138		
2.5	0.25	24	3	6	● 191125	● 191139		
2.5	0.35	24	4.5	6			● 192795	● 192798
2.6	0.35	24	4.5	6			● 192796	● 192799



All nano thread plug gauges are SCS-certified and the paid certificate is available on request.

UNC, UNF ASME B1.1 ASME B1.2

VHM
CAR

nano

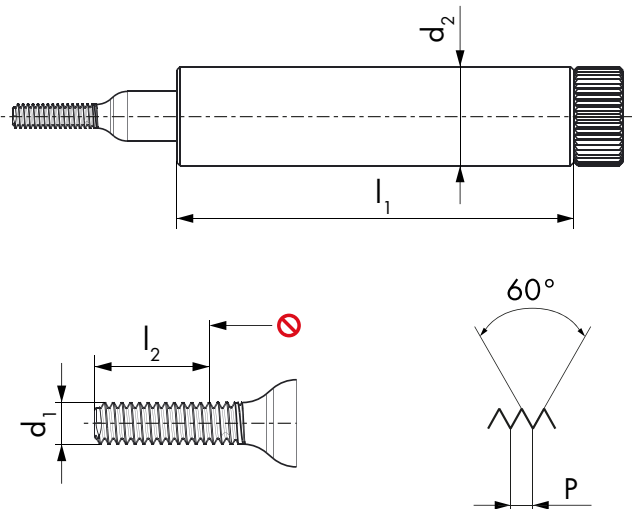

DN01 GO DN02 NO-GO DN01 GO DN02 NO-GO



$\emptyset d_1$ UNC	P TPI	$\emptyset d_1$ mm	l_1 mm	l_2 GO mm	d_2	ID	ID	ID	ID
1	64	1.854	24	6.35	6	● 191577	● 191580	● 191583	● 191586
2	54	2.184	24	6.35	6	● 191578	● 191581	● 191584	● 191587
3	48	2.515	24	6.35	6	● 191579	● 191582	● 191585	● 191588
$\emptyset d_1$ UNF	P TPI	$\emptyset d_1$ mm	l_1 mm	l_2 GO mm	d_2	ID	ID	ID	ID
0	80	1.524	24	4.76	6	● 191637	● 191641	● 191645	● 191649
1	72	1.854	24	4.76	6	● 191638	● 191642	● 191646	● 191650
2	64	2.184	24	4.76	6	● 191639	● 191643	● 191647	● 191651
3	56	2.515	24	4.76	6	● 191640	● 191644	● 191648	● 191652



All nano thread plug gauges are SCS-certified and the paid certificate is available on request.

nano

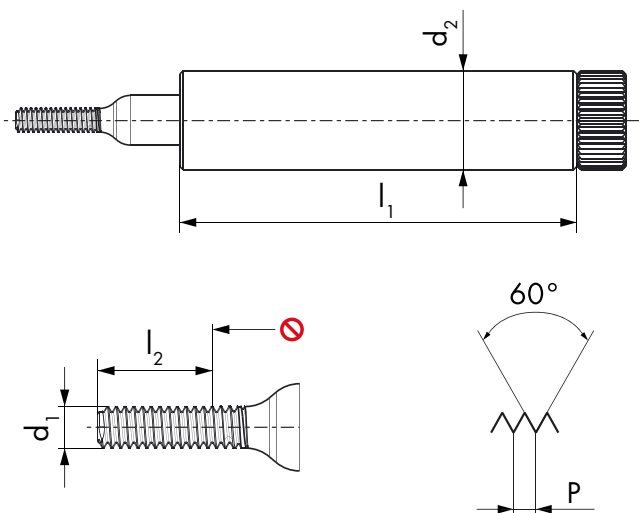

DN01 GO

DN01 GO

DN02 NO-GO



NIHS
3G

NIHS
4H

NIHS
4H/3G

θ S	d_1 mm	P mm	l_1 mm	l_2 GO mm	d_2	ID	ID	ID
0.3	0.08	0.08	24	0.9	6	● 190733	● 193242	● 190752
0.35	0.09	0.09	24	1.05	6	● 190734	● 193243	● 190753
0.4	0.1	0.1	24	1.2	6	● 190735	● 193244	● 190754
0.5	0.125	0.125	24	1.5	6	● 190736	● 193245	● 190755
0.6	0.15	0.15	24	1.8	6	● 190737	● 193246	● 190756
0.7	0.175	0.175	24	2.1	6	● 190738	● 193247	● 190757
0.8	0.2	0.2	24	2.4	6	● 190739	● 193248	● 190758
0.9	0.225	0.225	24	2.7	6	● 190740	● 193249	● 190759
1	0.25	0.25	24	3	6	● 190741	● 193250	● 190760
1.2	0.25	0.25	24	3.6	6	● 190742	● 193251	● 190761
1.4	0.3	0.3	24	4.2	6	● 190743	● 193252	● 190762



All nano thread plug gauges are SCS-certified and the paid certificate is available on request.

nano						DN01 GO	DN02 NO-GO		
$\frac{\theta}{S}$	d_1 mm	P mm	l_1 mm	l_2 GO mm	d_2	ID	ID		
0.3	0.3	0.08	24	0.9	6	● 190771	● 190790		
0.35	0.35	0.09	24	1.05	6	● 190772	● 190791		
0.4	0.4	0.1	24	1.2	6	● 190773	● 190792		
0.5	0.5	0.125	24	1.5	6	● 190774	● 190793		
0.6	0.6	0.15	24	1.8	6	● 190775	● 190794		
0.7	0.7	0.175	24	2.1	6	● 190776	● 190795		
0.8	0.8	0.2	24	2.4	6	● 190777	● 190796		
0.9	0.9	0.225	24	2.7	6	● 190778	● 190797		
1	1	0.25	24	3	6	● 190779	● 190798		
1.2	1.2	0.25	24	3.6	6	● 190780	● 190799		
1.4	1.4	0.3	24	4.2	6	● 190781	● 190800		

¹ Tol. 5H



All nano thread plug gauges are SCS-certified and the paid certificate is available on request.

nano

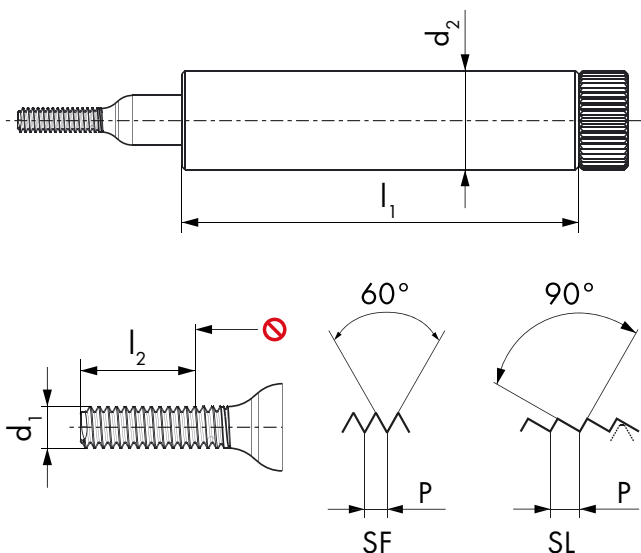

DN01 GO

DN01 GO

DN02 NO-GO



$\emptyset d_1$ SF	P mm	l_1 mm	l_2 GO mm	d_2	ID	ID	ID
1.4	0.2	24	4.2	6	● 190744	● 193256	● 190763
1.6	0.2	24	3	6	● 190745	● 193257	● 190764
1.8	0.2	24	3	6	● 190746	● 193258	● 190765
2	0.2	24	3	6	● 190747	● 193259	● 190766
2.2	0.2	24	3	6	● 190748	● 193260	● 190767
2.2	0.25	24	3	6	● 190749	● 193261	● 190768
2.5	0.2	24	3	6	● 190750	● 193262	● 190769
2.5	0.25	24	3	6	● 190751	● 193263	● 190770

$\emptyset d_1$ SL	P mm	l_1 mm	l_2 GO mm	d_2	ID	ID
0.5	0.1	24	1.5	6	● 600178	● 600186
0.6	0.125	24	1.8	6	● 600179	● 600187
0.7	0.15	24	2.1	6	● 600180	● 600188
0.8	0.15	24	2.4	6	● 600181	● 600189
0.9	0.175	24	2.7	6	● 600182	● 600190
1	0.2	24	3	6	● 600183	● 600191
1.2	0.2	24	3.6	6	● 600184	● 600192
1.4	0.25	24	4.2	6	● 600185	● 600193



All nano thread plug gauges are SCS-certified and the paid certificate is available on request.

nano

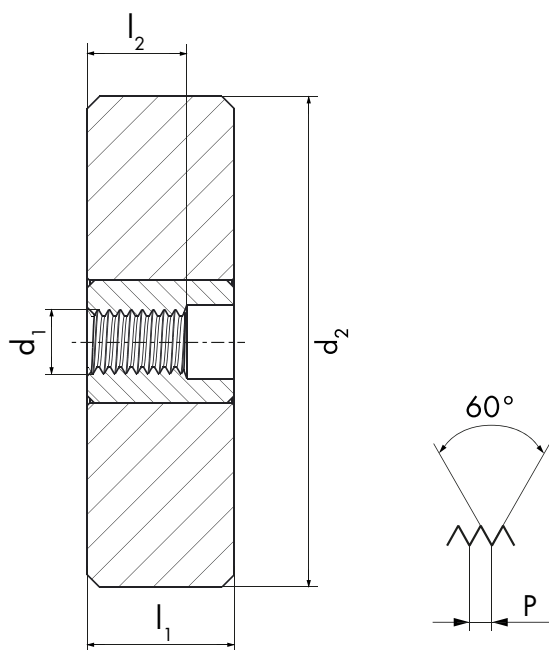

DZ04 GO

DZ14 NO-GO

DZ04 GO

DZ14 NO-GO



5h

5h

6g

6g

$\emptyset d_1$ M	P mm	l_1 mm	l_2 GO mm	d_2	ID	ID	ID	ID
0.5	0.125	6	0.75	20	● 192845	● 192853		
0.6	0.15	6	0.9	20	● 192846	● 192854		
0.7	0.175	6	1.05	20	● 192847	● 192855		
0.8	0.2	6	1.2	20	● 192848	● 192856		
0.9	0.225	6	1.35	20	● 192849	● 192857		
1	0.25	6	1.5	20			● 191473 ¹	● 191476 ¹
1.2	0.25	6	1.8	20			● 191474 ¹	● 191477 ¹
1.4	0.3	6	2.1	20			● 191475 ¹	● 191478 ¹
1.6	0.35	6	2.4	20			● 191479	● 191485
1.8	0.35	6	2.7	20			● 191480	● 191486
2	0.4	6	3	20			● 191481	● 191487
2.3	0.4	6	3.45	20			● 191482	● 191488
2.5	0.45	6	3.75	20			● 191483	● 191489
2.6	0.45	6	3.9	20			● 191484	● 191490

¹ Tol. 6h



All nano ring gauges have a certificate of measurement, established with SCS certified plug check gauges. The paid certificate is available on request.

nano						DZ04 GO	DZ14 NO-GO	DZ04 GO	DZ14 NO-GO
$\varnothing d_1$ MF	P mm	l_1 mm	l_2 GO mm	d_2	ID	ID	ID	ID	
1.4	0.2	6	2.1	20	● 194887	● 194888	● 192858 ¹	● 192871 ¹	
1.6	0.2	6	1.8	20	● 191201	● 191215	● 191229	● 191243	
1.8	0.2	6	1.8	20	● 191202	● 191216	● 191230	● 191244	
2	0.2	6	1.8	20	● 190711	● 190710	● 191231	● 191245	
2	0.25	6	2.25	20	● 194872	● 190690	● 194876	● 194877	
2.2	0.2	6	1.8	20	● 191204	● 191218	● 191232	● 191246	
2.2	0.25	6	2.25	20	● 191205	● 191219	● 191233	● 191247	
2.3	0.2	6	1.8	20	● 191206	● 191220	● 191234	● 191248	
2.3	0.25	6	2.25	20	● 191207	● 191221	● 191235	● 191249	
2.5	0.2	6	1.8	20	● 191208	● 191222	● 191236	● 191250	
2.5	0.25	6	2.25	20	● 194873	● 191223	● 191237	● 191251	
2.5	0.35	6	3.75	20			● 192869	● 192882	
2.6	0.35	6	3.9	20			● 192870	● 192883	

¹ Tol. 6h



All nano ring gauges have a certificate of measurement, established with SCS certified plug check gauges. The paid certificate is available on request.



UNC, UNF ASME B1.1 ASME B1.2

PHYN.
KL

nano						DZ04 GO	DZ14 NO-GO	DZ04 GO	DZ14 NO-GO
						2A	2A	3A	3A
$\varnothing d_1$ UNC	P TPI	$\varnothing d_1$ mm	l_1 mm	l_2 GO mm	d_2	ID	ID	ID	ID
1	64	1.854	6	2.78	20	● 191601	● 191604	● 191607	● 191610
2	56	2.184	6	3.28	20	● 191602	● 191605	● 191608	● 191611
3	48	2.515	6	3.77	20	● 191603	● 191606	● 191609	● 191612
$\varnothing d_1$ UNF	P TPI	$\varnothing d_1$ mm	l_1 mm	l_2 GO mm	d_2	ID	ID	ID	ID
0	80	1.524	6	2.29	20	● 191669	● 191673	● 191677	● 191681
1	72	1.854	6	2.78	20	● 191670	● 191674	● 191678	● 191682
2	64	2.184	6	3.28	20	● 191671	● 191675	● 191679	● 191683
3	56	2.515	6	3.77	20	● 191672	● 191676	● 191680	● 191684



All nano ring gauges have a certificate of measurement, established with SCS certified plug check gauges. The paid certificate is available on request.

nano						DZ04 GO	DZ14 NO-GO	DZ04 GO	DZ14 NO-GO
$\emptyset d_1$ S	P mm	l_1 mm	l_2 GO mm	d_2	ID	ID	ID	ID	
0.5	0.125	6	0.75	20	● 190812	● 190831	● 190850	● 190869	
0.6	0.15	6	0.9	20	● 190813	● 190832	● 190851	● 190870	
0.7	0.175	6	1.05	20	● 190814	● 190833	● 190852	● 190871	
0.8	0.2	6	1.2	20	● 190815	● 190834	● 190853	● 190872	
0.9	0.225	6	1.35	20	● 190816	● 190835	● 190854	● 190873	
1	0.25	6	1.5	20	● 190817	● 190836	● 190855	● 190874	
1.2	0.25	6	1.8	20	● 190818	● 190837	● 190856	● 190875	
1.4	0.3	6	2.1	20	● 190819	● 190838	● 190857	● 190876	



All nano ring gauges have a certificate of measurement, established with SCS certified plug check gauges. The paid certificate is available on request.

nano						DZ04 GO	DZ14 NO-GO		
$\emptyset d_1$ SF	P mm	l_1 mm	l_2 GO mm	d_2	ID	ID			
1.4	0.2	6	2.1	20	● 190820	● 190839			
1.6	0.2	6	1.8	20	● 190821	● 190840			
1.8	0.2	6	1.8	20	● 190822	● 190841			
2	0.2	6	1.8	20	● 190823	● 190842			
2.2	0.2	6	1.8	20	● 190824	● 190843			
2.2	0.25	6	2.25	20	● 190825	● 190844			
2.5	0.2	6	1.8	20	● 190826	● 190845			
2.5	0.25	6	2.25	20	● 190827	● 190846			



All nano ring gauges have a certificate of measurement, established with SCS certified plug check gauges. The paid certificate is available on request.

nano

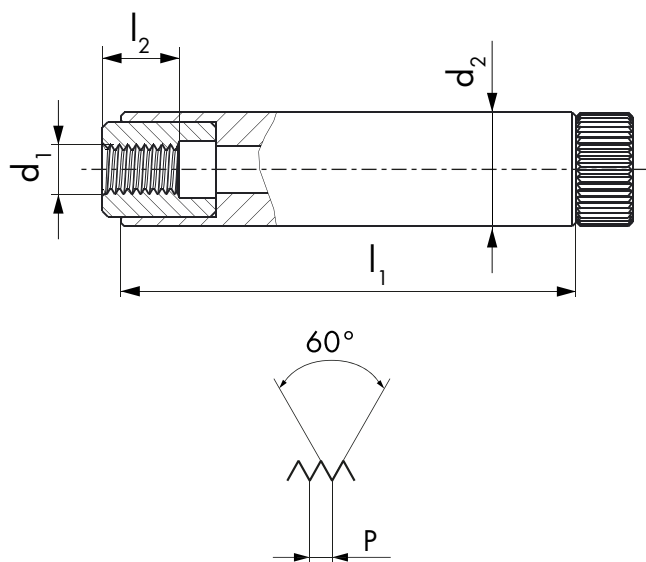

DN04 GO

DN14 NO-GO

DN04 GO

DN14 NO-GO



$\emptyset d_1$ M	P mm	l_1 mm	l_2 GO mm	d_2	ID	ID	ID	ID
0.5	0.125	24	0.75	6	● 192803	● 192811		
0.6	0.15	24	0.9	6	● 192804	● 192812		
0.7	0.175	24	1.05	6	● 192805	● 192813		
0.8	0.2	24	1.2	6	● 192806	● 192814		
0.9	0.225	24	1.35	6	● 192807	● 192815		
1	0.25	24	1.5	6			● 191447 ¹	● 191450 ¹
1.2	0.25	24	1.8	6			● 191448 ¹	● 191451 ¹
1.4	0.3	24	2.1	6			● 191449 ¹	● 191452 ¹
1.6	0.35	24	2.4	6			● 191453	● 191459
1.8	0.35	24	2.7	6			● 191454	● 191460
2	0.4	24	3	6			● 191455	● 191461
2.3	0.4	24	3.45	6			● 191456	● 191462
2.5	0.45	24	3.75	6			● 191457	● 191463
2.6	0.45	24	3.9	6			● 191458	● 191464

¹ Tol. 6h



All nano ring gauges have a certificate of measurement, established with SCS certified plug check gauges. The paid certificate is available on request.



nano

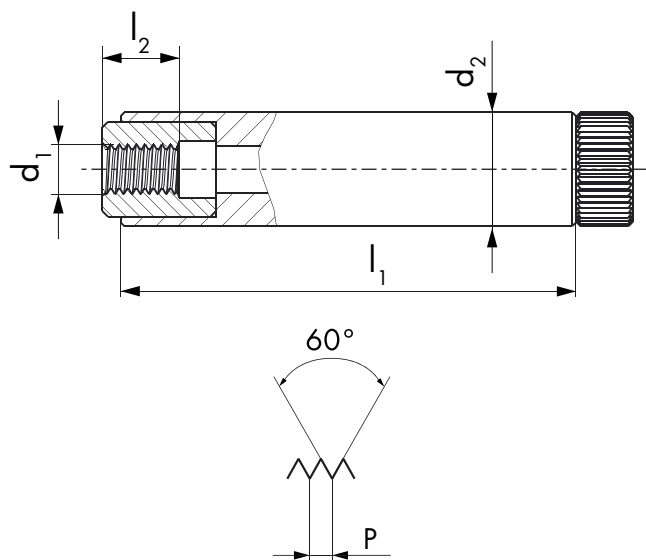

DN04 GO

DN14 NO-GO

DN04 GO

DN14 NO-GO



$\emptyset d_1$ MF	P mm	l_1 mm	l_2 GO mm	d_2	ID	ID	ID	ID
1.4	0.2	24	2.1	6	● 194885	● 194886	● 192816 ¹	● 192829 ¹
1.6	0.2	24	1.8	6	● 191145	● 191159	● 191173	● 191187
1.8	0.2	24	1.8	6	● 191146	● 191160	● 191174	● 191188
2	0.2	24	1.8	6	● 191147	● 191161	● 191175	● 191189
2	0.25	24	2.25	6	● 194870	● 194871	● 194874	● 194875
2.2	0.2	24	1.8	6	● 191148	● 191162	● 191176	● 191190
2.2	0.25	24	2.25	6	● 191149	● 191163	● 191177	● 191191
2.3	0.2	24	1.8	6	● 191150	● 191164	● 191178	● 191192
2.3	0.25	24	2.25	6	● 191151	● 191165	● 191179	● 191193
2.5	0.2	24	1.8	6	● 191152	● 191166	● 191180	● 191194
2.5	0.25	24	2.25	6	● 191153	● 191167	● 191181	● 191195
2.5	0.35	24	3.75	6			● 192827	● 192840
2.6	0.35	24	3.9	6			● 192828	● 192841

¹ Tol. 6h



All nano ring gauges have a certificate of measurement, established with SCS certified plug check gauges. The paid certificate is available on request.

UNC, UNF ASME B1.1 ASME B1.2

PHYN.
KL

nano						DN04 GO	DN14 NO-GO	DN04 GO	DN14 NO-GO
						2A	2A	3A	3A
$\varnothing d_1$ UNC	P TPI	$\varnothing d_1$ mm	l_1 mm	l_2 GO mm	d_2	ID	ID	ID	ID
1	64	1.854	24	2.78	6	● 191589	● 191592	● 191595	● 191598
2	56	2.184	24	3.28	6	● 191590	● 191593	● 191596	● 191599
3	48	2.515	24	3.77	6	● 191591	● 191594	● 191597	● 191600
$\varnothing d_1$ UNF	P TPI	$\varnothing d_1$ mm	l_1 mm	l_2 GO mm	d_2	ID	ID	ID	ID
0	80	1.524	24	2.29	6	● 191653	● 191657	● 191661	● 191665
1	72	1.854	24	2.78	6	● 191654	● 191658	● 191662	● 191666
2	64	2.184	24	3.28	6	● 191655	● 191659	● 191663	● 191667
3	56	2.515	24	3.77	6	● 191656	● 191660	● 191664	● 191668



All nano ring gauges have a certificate of measurement, established with SCS certified plug check gauges. The paid certificate is available on request.



nano

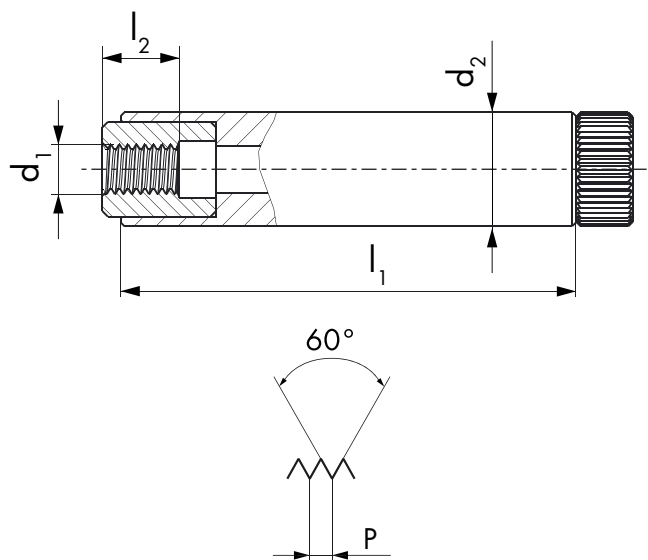

DN04 GO

DN14 NO-GO

DN04 GO

DN14 NO-GO



$\emptyset d_1$ S	P mm	l_1 mm	l_2 GO mm	d_2	ID	ID	ID	ID
0.5	0.125	24	0.75	6	● 190888	● 190907	● 190926	● 190945
0.6	0.15	24	0.9	6	● 190889	● 190908	● 190927	● 190946
0.7	0.175	24	1.05	6	● 190890	● 190909	● 190928	● 190947
0.8	0.2	24	1.2	6	● 190891	● 190910	● 190929	● 190948
0.9	0.225	24	1.35	6	● 190892	● 190911	● 190930	● 190949
1	0.25	24	1.5	6	● 190893	● 190912	● 190931	● 190950
1.2	0.25	24	1.8	6	● 190894	● 190913	● 190932	● 190951
1.4	0.3	24	2.1	6	● 190895	● 190914	● 190933	● 190952



All nano ring gauges have a certificate of measurement, established with SCS certified plug check gauges. The paid certificate is available on request.

nano

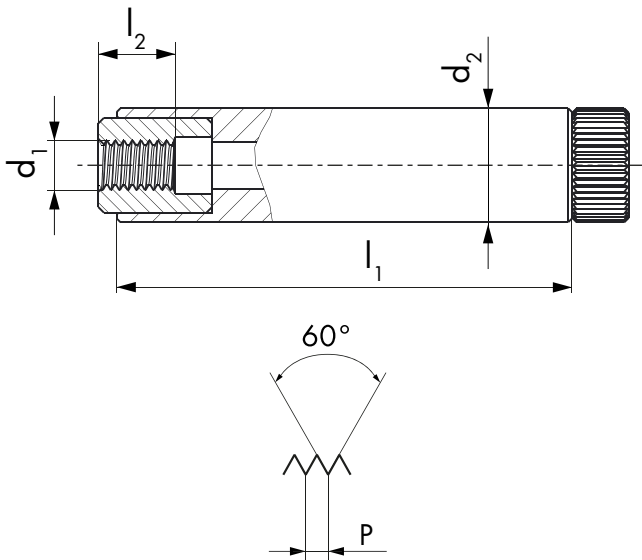

DN04 GO

DN14 NO-GO



$\emptyset d_1$ SF	P mm	l_1 mm	l_2 GO mm	d_2	ID	ID
1.4	0.2	24	2.1	6	● 190896	● 190915
1.6	0.2	24	1.8	6	● 190897	● 190916
1.8	0.2	24	1.8	6	● 190898	● 190917
2	0.2	24	1.8	6	● 190899	● 190918
2.2	0.2	24	1.8	6	● 190900	● 190919
2.2	0.25	24	2.25	6	● 190901	● 190920
2.5	0.2	24	1.8	6	● 190902	● 190921
2.5	0.25	24	2.28	6	● 190903	● 190922



All nano ring gauges have a certificate of measurement, established with SCS certified plug check gauges. The paid certificate is available on request.

nano

RN05-1 GO

RN15-1 GO

RN05-1 GO

RN15-1 GO

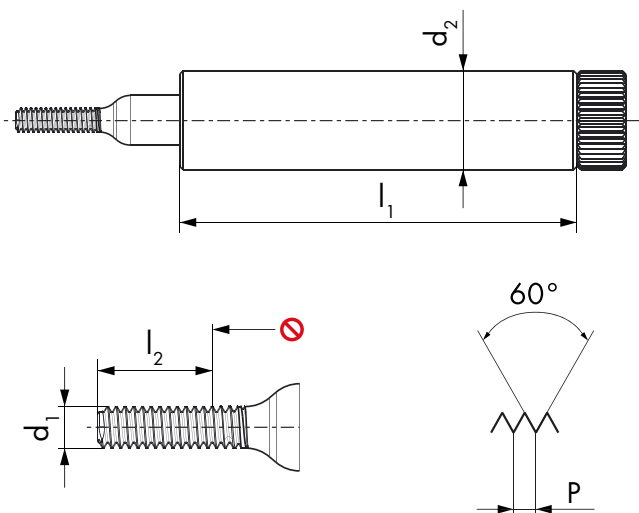

5h

5h

6g

6g

$\emptyset d_1$ M	P mm	l_1 mm	l_2 GO mm	d_2	ID	ID	ID	ID
0.3	0.08	24	0.61	6	● 192884	● 192892		
0.35	0.09	24	0.71	6	● 192885	● 192893		
0.4	0.1	24	0.8	6	● 192886	● 192894		
0.5	0.125	24	1	6	● 192887	● 192895		
0.6	0.15	24	1.2	6	● 192888	● 192896		
0.7	0.175	24	1.4	6	● 192889	● 192897		
0.8	0.2	24	1.6	6	● 192890	● 192898		
0.9	0.225	24	1.8	6	● 192891	● 192899		
1	0.25	24	2	6			● 191499 ¹	● 191508 ¹
1.2	0.25	24	2.3	6			● 191500 ¹	● 191509 ¹
1.4	0.3	24	2.7	6			● 191501 ¹	● 191510 ¹
1.6	0.35	24	3.1	6			● 191517	● 191535
1.8	0.35	24	3.4	6			● 191518	● 191536
2	0.4	24	3.8	6			● 191519	● 191537
2.3	0.4	24	4.25	6			● 191520	● 191538
2.5	0.45	24	4.65	6			● 191521	● 191539
2.6	0.45	24	4.8	6			● 191522	● 191540

¹ Tol. 6h



SCS certificate included.

nano

RN05-1 GO

RN15-1 GO

RN05-1 GO

RN15-1 GO

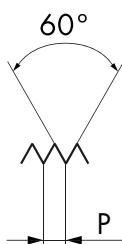
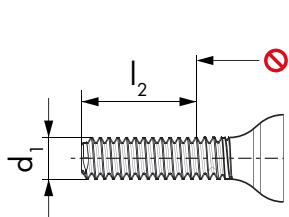
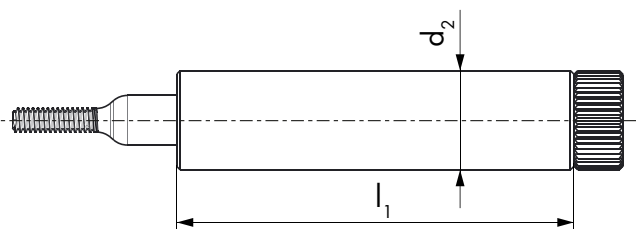

6h

6h

6g

6g

$\emptyset d_1$ MF	P mm	l_1 mm	l_2 GO mm	d_2	ID	ID	ID	ID
1.4	0.2	24	2.5	6	● 192932	● 192945		
1.6	0.2	24	2.2	6	● 192933	● 192946		
1.8	0.2	24	2.2	6	● 192934	● 192947		
2	0.2	24	2.2	6	● 192935	● 192948		
2	0.25	24	2.75	6	● 192936	● 192949		
2.2	0.2	24	2.2	6	● 192937	● 192950		
2.2	0.25	24	2.75	6	● 192938	● 192951		
2.3	0.2	24	2.2	6	● 192939	● 192952		
2.3	0.25	24	2.75	6	● 192940	● 192953		
2.5	0.2	24	2.2	6	● 192941	● 192954		
2.5	0.25	24	2.75	6	● 192942	● 192955		
2.5	0.35	24	4.45	6			● 192943	● 192956
2.6	0.35	24	4.6	6			● 192944	● 192957



SCS certificate included.



UNC, UNF ASME B1.1 DC SWISS NI582

VHM
CAR

nano

RN05-1 GO

RN15-1 GO

RN05-1 GO

RN15-1 GO

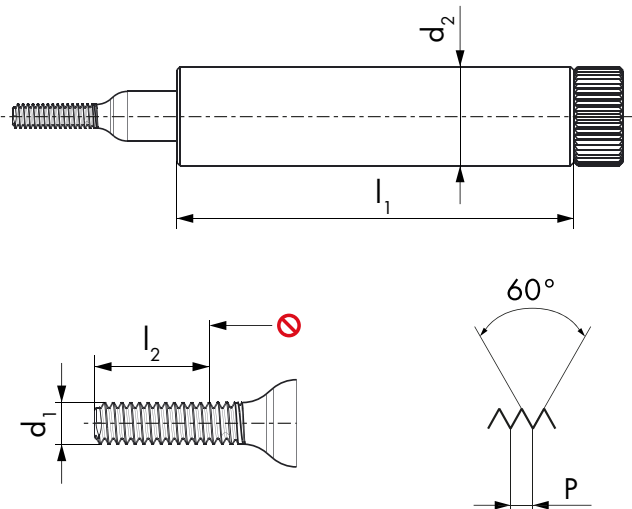

2A

2A

3A

3A

$\emptyset d_1$ UNC	P TPI	$\emptyset'' d_1$ mm	l_1 mm	l_2 GO mm	d_2	ID	ID	ID	ID
1	64	1.854	24	3.58	6	● 191613	● 191619	● 191625	● 191631
2	56	2.184	24	4.18	6	● 191614	● 191620	● 191626	● 191632
3	48	2.515	24	4.83	6	● 191615	● 191621	● 191627	● 191633
$\emptyset d_1$ UNF	P TPI	$\emptyset'' d_1$ mm	l_1 mm	l_2 GO mm	d_2	ID	ID	ID	ID
0	80	1.524	24	2.92	6	● 191685	● 191693	● 191701	● 191709
1	72	1.854	24	3.49	6	● 191686	● 191694	● 191702	● 191710
2	64	2.184	24	4.07	6	● 191687	● 191695	● 191703	● 191711
3	56	2.515	24	4.68	6	● 191688	● 191696	● 191704	● 191712



SCS certificate included.

nano

RN05-1 GO

RN15-1 GO

RN05-1 GO

RN15-1 GO

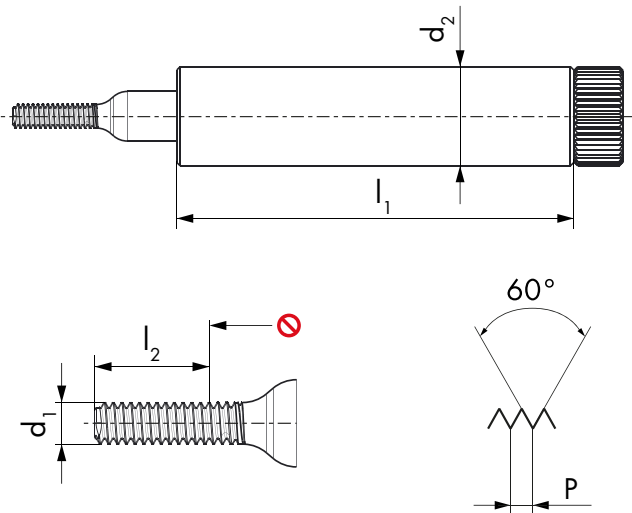

$\emptyset d_1$ S	P mm	l_1 mm	l_2 GO mm	d_2	ID	ID	ID	ID
0.3	0.08	24	0.61	6	● 190961	● 190999	● 191037	● 191075
0.35	0.09	24	0.71	6	● 190962	● 191000	● 191038	● 191076
0.4	0.1	24	0.8	6	● 190963	● 191001	● 191039	● 191077
0.5	0.125	24	1	6	● 190964	● 191002	● 191040	● 191078
0.6	0.15	24	1.2	6	● 190965	● 191003	● 191041	● 191079
0.7	0.175	24	1.4	6	● 190966	● 191004	● 191042	● 191080
0.8	0.2	24	1.6	6	● 190967	● 191005	● 191043	● 191081
0.9	0.225	24	1.8	6	● 190968	● 191006	● 191044	● 191082
1	0.25	24	2	6	● 190969	● 191007	● 191045	● 191083
1.2	0.25	24	2.3	6	● 190970	● 191008	● 191046	● 191084
1.4	0.3	24	2.7	6	● 190971	● 191009	● 191047	● 191085



SCS certificate included.



nano

RN05-1 GO

RN15-1 GO

RN05-1 GO

RN15-1 GO

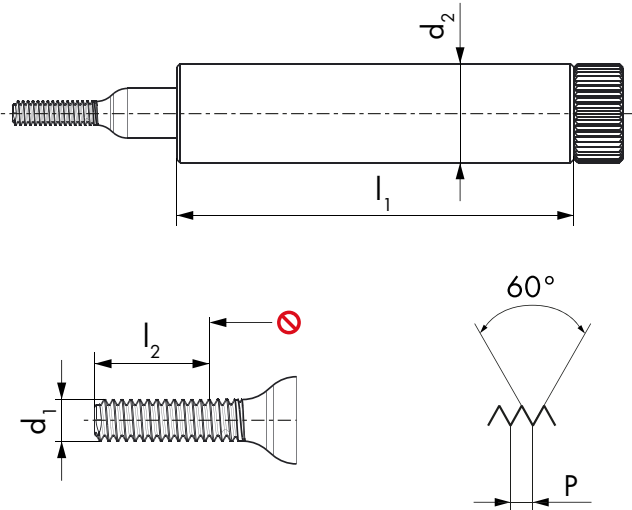

$\emptyset d_1$ SF	P mm	l_1 mm	l_2 GO mm	d_2	ID	ID	ID	ID
1.4	0.2	24	2.5	6	● 190972	● 191010	● 191048	● 191086
1.6	0.2	24	2.2	6	● 190973	● 191011	● 191049	● 191087
1.8	0.2	24	2.2	6	● 190974	● 191012	● 191050	● 191088
2	0.2	24	2.2	6	● 190975	● 191013	● 191051	● 191089
2.2	0.2	24	2.2	6	● 190976	● 191014	● 191052	● 191090
2.2	0.25	24	2.75	6	● 190977	● 191015	● 191053	● 191091
2.5	0.2	24	2.2	6	● 190978	● 191016	● 191054	● 191092
2.5	0.25	24	2.75	6	● 190979	● 191017	● 191055	● 191093



SCS certificate included.



ISO DIN 14 / ISO DIN 13
DC SWISS NI589 / ISO 1502



nano

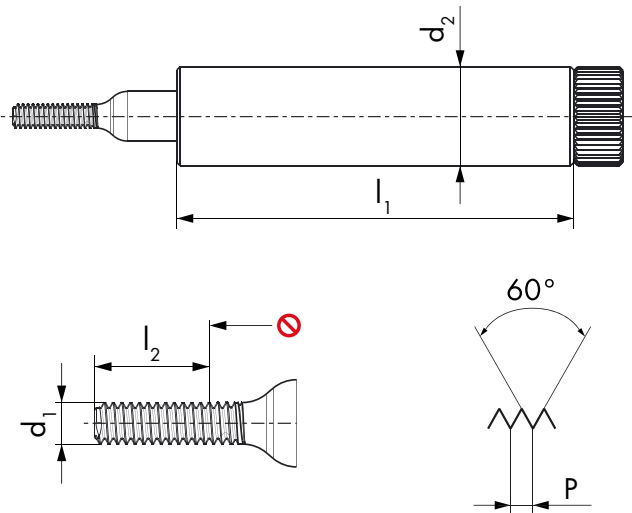

RN05-2
NO-GO

RN15-2
NO-GO

RN05-2
NO-GO

RN15-2
NO-GO



5h

5h

6g

6g

$\emptyset d_1$ M	P mm	l_1 mm	l_2 GO mm	d_2	ID	ID	ID	ID
0.3	0.08	24	0.61	6	● 192900	● 192908		
0.35	0.09	24	0.71	6	● 192901	● 192909		
0.4	0.1	24	0.8	6	● 192902	● 192910		
0.5	0.125	24	1	6	● 192903	● 192911		
0.6	0.15	24	1.2	6	● 192904	● 192912		
0.7	0.175	24	1.4	6	● 192905	● 192913		
0.8	0.2	24	1.6	6	● 192906	● 192914		
0.9	0.225	24	1.8	6	● 192907	● 192915		
1	0.25	24	2	6			● 191502 ¹	● 191511 ¹
1.2	0.25	24	2.3	6			● 191503 ¹	● 191512 ¹
1.4	0.3	24	2.7	6			● 191504 ¹	● 191513 ¹
1.6	0.35	24	3.1	6			● 191523	● 191541
1.8	0.35	24	3.4	6			● 191524	● 191542
2	0.4	24	3.8	6			● 191525	● 191543
2.3	0.4	24	4.25	6			● 191526	● 191544
2.5	0.45	24	4.65	6			● 191527	● 191545
2.6	0.45	24	4.8	6			● 191528	● 191546

¹ Tol. 6h



SCS certificate included.



nano

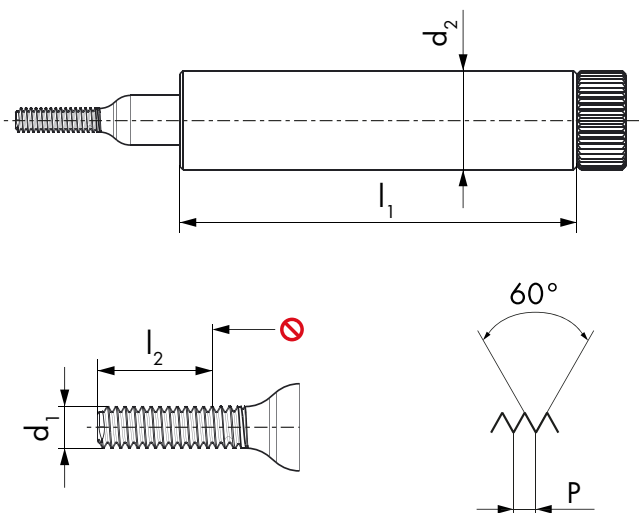

**RN05-2
NO-GO**

**RN15-2
NO-GO**

**RN05-2
NO-GO**

**RN15-2
NO-GO**



6h

6h

6g

6g

$\varnothing d_1$ MF	P mm	l_1 mm	l_2 GO mm	d_2	ID	ID	ID	ID
1.4	0.2	24	2.5	6	● 192958	● 192971		
1.6	0.2	24	1.6	6	● 192959	● 192972		
1.8	0.2	24	1.6	6	● 192960	● 192973		
2	0.2	24	1.6	6	● 192961	● 192974		
2	0.25	24	2	6	● 192962	● 192975		
2.2	0.2	24	1.6	6	● 192963	● 192976		
2.2	0.25	24	2	6	● 192964	● 192977		
2.3	0.2	24	1.6	6	● 192965	● 192978		
2.3	0.25	24	2	6	● 192966	● 192979		
2.5	0.2	24	1.6	6	● 192967	● 192980		
2.5	0.25	24	2	6	● 192968	● 192981		
2.5	0.35	24	4.45	6			● 192969	● 192982
2.6	0.35	24	4.6	6			● 192970	● 192983



SCS certificate included.

UNC, UNF ASME B1.1 DC SWISS NI582

VHM
CAR

nano

RN05-2
NO-GO

RN15-2
NO-GO

RN05-2
NO-GO

RN15-2
NO-GO

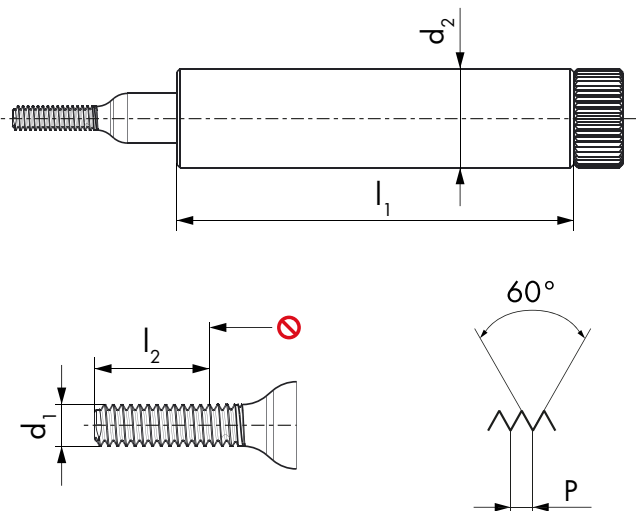

2A

2A

3A

3A

$\emptyset d_1$ UNC	P TPI	$\emptyset d_1$ mm	l_1 mm	l_2 GO mm	d_2	ID	ID	ID	ID
1	64	1.854	24	3.58	6	● 191616	● 191622	● 191628	● 191634
2	56	2.184	24	4.18	6	● 191617	● 191623	● 191629	● 191635
3	48	2.515	24	4.83	6	● 191618	● 191624	● 191630	● 191636
$\emptyset d_1$ UNF	P TPI	$\emptyset d_1$ mm	l_1 mm	l_2 GO mm	d_2	ID	ID	ID	ID
0	80	1.524	24	2.92	6	● 191689	● 191697	● 191705	● 191713
1	72	1.854	24	3.49	6	● 191690	● 191698	● 191706	● 191714
2	64	2.184	24	4.07	6	● 191691	● 191699	● 191707	● 191715
3	56	2.515	24	4.68	6	● 191692	● 191700	● 191708	● 191716



SCS certificate included.



nano

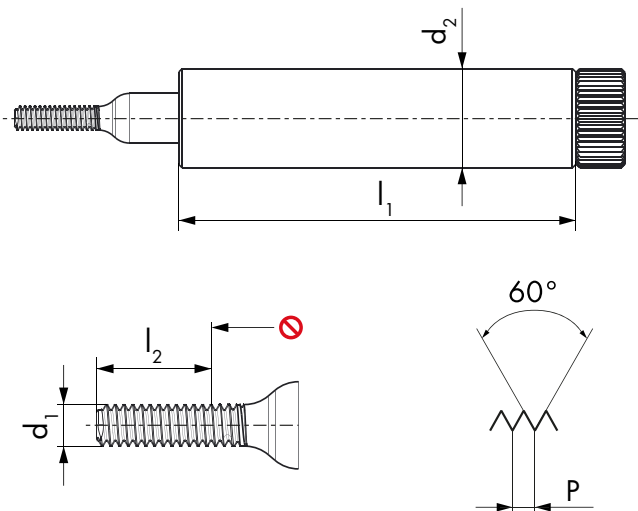

**RN05-2
NO-GO**

**RN15-2
NO-GO**

**RN05-2
NO-GO**

**RN15-2
NO-GO**



$\emptyset d_1$ S	P mm	l_1 mm	l_2 GO mm	d_2	ID	ID	ID	ID
0.3	0.08	24	0.61	6	● 190980	● 191018	● 191056	● 191094
0.35	0.09	24	0.71	6	● 190981	● 191019	● 191057	● 191095
0.4	0.1	24	0.8	6	● 190982	● 191020	● 191058	● 191096
0.5	0.125	24	1	6	● 190983	● 191021	● 191059	● 191097
0.6	0.15	24	1.2	6	● 190984	● 191022	● 191060	● 191098
0.7	0.175	24	1.4	6	● 190985	● 191023	● 191061	● 191099
0.8	0.2	24	1.6	6	● 190986	● 191024	● 191062	● 191100
0.9	0.225	24	1.8	6	● 190987	● 191025	● 191063	● 191101
1	0.25	24	2	6	● 190988	● 191026	● 191064	● 191102
1.2	0.25	24	2.3	6	● 190989	● 191027	● 191065	● 191103
1.4	0.3	24	2.7	6	● 190990	● 191028	● 191066	● 191104



SCS certificate included.

nano

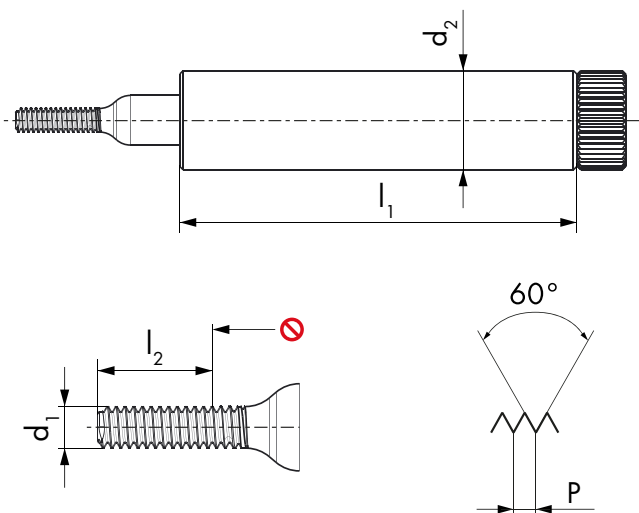

RN05-2
NO-GO

RN15-2
NO-GO

RN05-2
NO-GO

RN15-2
NO-GO



$\emptyset d_1$ SF	P mm	l_1 mm	l_2 GO mm	d_2	ID	ID	ID	ID
1.4	0.2	24	2.5	6	● 190991	● 191029	● 191067	● 191105
1.6	0.2	24	1.6	6	● 190992	● 191030	● 191068	● 191106
1.8	0.2	24	1.6	6	● 190993	● 191031	● 191069	● 191107
2	0.2	24	1.6	6	● 190994	● 191032	● 191070	● 191108
2.2	0.2	24	1.6	6	● 190995	● 191033	● 191071	● 191109
2.2	0.25	24	2	6	● 190996	● 191034	● 191072	● 191110
2.5	0.2	24	1.6	6	● 190997	● 191035	● 191073	● 191111
2.5	0.25	24	2	6	● 190998	● 191036	● 191074	● 191112



SCS certificate included.





ISO DIN 13
ISO 1502

VHM
CAR

nano

RN05-3
WEAR

RN15-3
WEAR

RN05-3
WEAR

RN15-3
WEAR

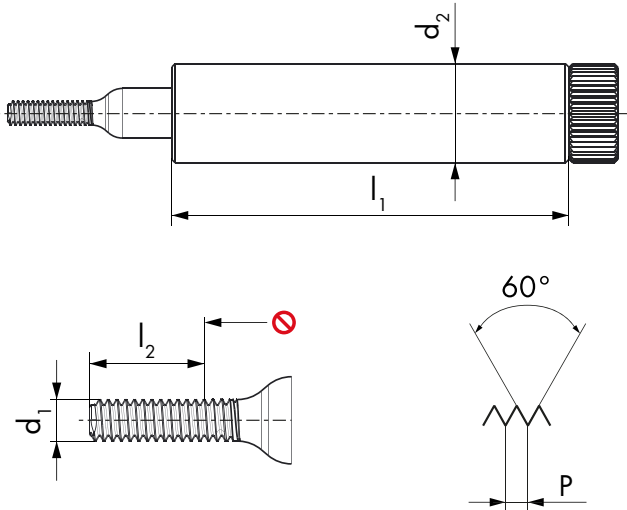

6h

6h

6g

6g

$\emptyset d_1$ M	P mm	l_1 mm	l_2 GO mm	d_2	ID	ID	ID	ID
1	0.25	24	2	6	● 191505	● 191514		
1.2	0.25	24	2.3	6	● 191506	● 191515		
1.4	0.3	24	2.7	6	● 191507	● 191516		
1.6	0.35	24	3.1	6			● 191529	● 191547
1.8	0.35	24	3.4	6			● 191530	● 191548
2	0.4	24	3.8	6			● 191531	● 191549
2.3	0.4	24	4.25	6			● 191532	● 191550
2.5	0.45	24	4.65	6			● 191533	● 191551
2.6	0.45	24	4.8	6			● 191534	● 191552



SCS certificate included.

nano

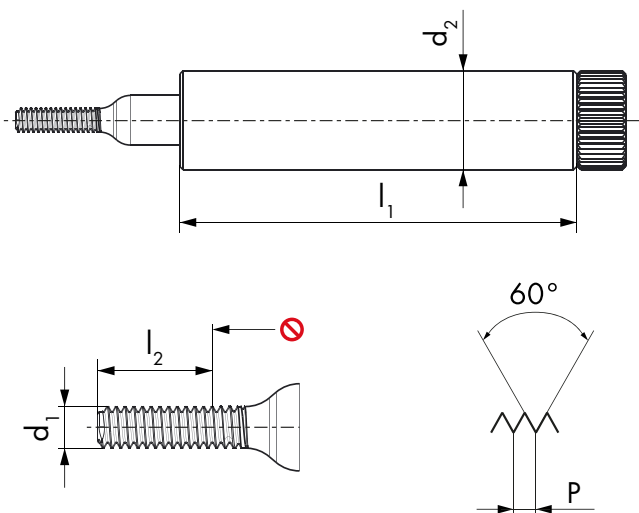

**RN05-3
WEAR**

**RN15-3
WEAR**

**RN05-3
WEAR**

**RN15-3
WEAR**



6h

6h

6g

6g

$\emptyset d_1$ MF	P mm	l_1 mm	l_2 GO mm	d_2	ID	ID	ID	ID
1.4	0.2	24	2.5	6	● 192984	● 192997		
1.6	0.2	24	1.6	6	● 192985	● 192998		
1.8	0.2	24	1.6	6	● 192986	● 192999		
2	0.2	24	1.6	6	● 192987	● 193000		
2	0.25	24	2	6	● 192988	● 193001		
2.2	0.2	24	1.6	6	● 192989	● 193002		
2.2	0.25	24	2	6	● 192990	● 193003		
2.3	0.2	24	1.6	6	● 192991	● 193004		
2.3	0.25	24	2	6	● 192992	● 193005		
2.5	0.2	24	1.6	6	● 192993	● 193006		
2.5	0.25	24	2	6	● 192994	● 193007		
2.5	0.35	24	4.45	6			● 192995	● 193008
2.6	0.35	24	4.6	6			● 192996	● 193009



SCS certificate included.



nano

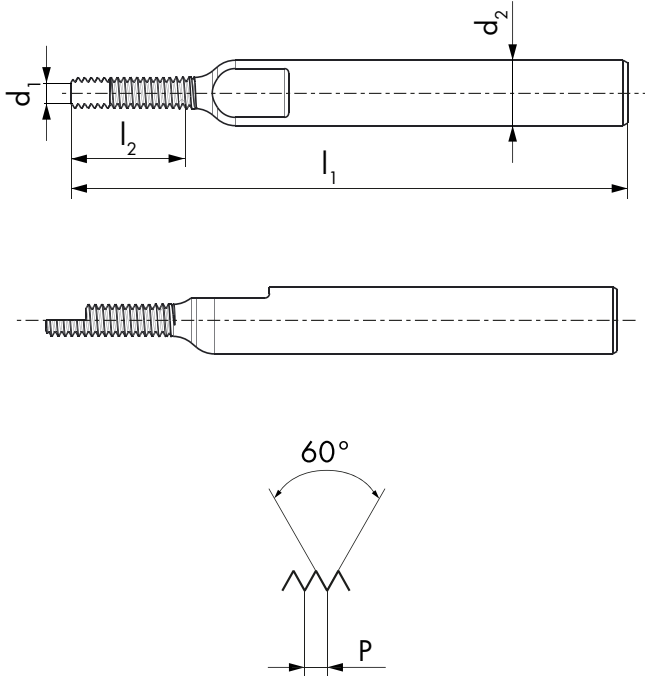

EN00



NIHS

$\emptyset d_1$ S	P mm	l_1 mm	l_2 GO mm	d_2	ID
0.3	0.08	39	1.28	3	● 192747
0.35	0.09	39	1.44	3	● 192748
0.4	0.1	39	1.6	3	● 192749
0.5	0.125	39	2	3	● 192750
0.6	0.15	39	2.4	3	● 192751
0.7	0.175	39	2.8	3	● 192752
0.8	0.2	39	3.2	3	● 192753
0.9	0.225	39	3.6	3	● 192754
1	0.25	39	4	3	● 192755
1.2	0.25	39	4	3	● 192756
1.4	0.3	39	4.8	3	● 192757

El Patrón roscado DC SWISS sirve para calibrar las maquinas de medición. Todos los patrones de nuestro programa son disponibles o sobre pedido en caso de ser específico. Son entregados con un certificado de homologación SCS que confirma que la producción a seguido estrictamente el proceso de medición al final de la fabricación según ISO 17025. Atesta de la calidad del equipo metrologico de DC NANO TOOLS SA (SCS 0143) centro de competencia y miembro del grupo DC SWISS.

The DC SWISS calibration thread plug gauge is used for the calibration of measuring machines. The calibration gauges from our catalogue, or made to your specific requirements, are delivered with a SCS measurement certificate. This confirms that the control process during production has been conscientiously followed to ISO 17025. It attests to the quality of the metrological equipment of DC NANO TOOLS SA (SCS 0143), centre of competence and member of the DC Group.



SCS certificate included.

**TODAS NUESTRAS HERRAMIENTAS PUEDEN SER
ORDENADAS VÍA NUESTRO **WEBSITE**.
INSCRIPCIÓN EN **DCSWISS.COM****



**YOU FIND
ALL THESE TOOLS ON OUR **WEBSHOP**
REGISTER NOW: **DCSWISS.COM****

TABLA DE DUREZA — HARDNESS CHART

HRC <i>Dureza Rockwell</i> Hardness Rockwell	HB <i>Dureza Brinell</i> Hardness Brinell	HV <i>Dureza Vickers</i> Hardness Vickers	N/mm² Mpa <i>Resistencia a la tracción</i> Tensile strength
25	253	266	854
26	259	273	873
27	265	279	897
28	272	286	919
29	279	294	944
30	287	302	970
31	295	310	995
32	303	318	1024
33	311	327	1052
34	320	336	1082
35	328	345	1111
36	337	355	1139
37	346	364	1168
38	354	373	1198
39	363	382	1227
40	373	392	1262
41	382	402	1296
42	392	412	1327
43	402	423	1362
44	413	434	1401
45	424	446	1442
46	436	459	1481
47	448	471	1524
48	460	484	1572
49	474	499	1625
50	488	513	1675
51	502	528	1733
52	518	545	1793
53	532	560	1845
54	549	578	1912
55	566	596	1979
56	585	615	2050
57	603	634	2121
58	621	654	2200
59		675	
60		698	
61		720	
62		746	
63		773	

Tabla de equivalencia de dureza, extracto de ISO EN 18265; 2003 / anteriormente DIN 50150. Valores redondeados
 Conversion chart for hardness values, extract from ISO EN 18265; 2003 / formerly DIN 50150. Rounded values.

PULGADAS-MM — INCHES-MM

Ø" d ₁	Ø mm	TPI UN											W(BSW)	BSF	G (BSP) Rp	Ø mm	
		UNC	UNF	UNEF	4	6	8	12	16	20	28	32					
0 1/16"	1.52 1.59		80											48		28	7.72
1 2 3/32"	1.85 2.18 2.38	64 56	72 64														
3 4 5 1/8"	2.51 2.84 3.17 3.17	48 40 40	56 48 44											40		28	9.72
6 5/32"	3.50	32	40											32			
8 3/16"	3.96 4.16 4.76	32	36											24	32		
10 12	4.82 5.48	24 24	32 28	32													
7/32"	5.55													24			
1/4"	6.35	20	28	32										20	28	19	13.15
9/32"	7.14														26		
5/16"	7.93	18	24	32					20	28					26		
3/8"	9.52	16	24	32					20	28				16	20	19	16.66
7/16"	11.11	14	20	28					16					14	18		
1/2"	12.70	13	20	28					16					12	16	14	20.95
9/16"	14.28	12	18	24					16	20	28			12	16		
5/8"	15.87	11	18	24				12	16	20	28	32		11	14	14	22.91
11/16"	17.46			24				12	16	20	28	32			14		
3/4"	19.05	10	16	20				12			28	32		10	12	14	26.44
13/16"	20.64			20				12	16		28	32			12		
7/8"	22.22	9	14	20				12	16		28	32		9	11	14	30.20
15/16"	23.81			20				12	16		28	32					
1"	25.40	8	12	20				12	16		28	32		8	10	11	33.24
1 1/16"	26.99			18			8	12	16	20	28						
1 1/8"	28.57	7	12	18			8		16	20	28			7	9	11	37.89
1 3/16"	30.16			18			8	12	16	20	28						
1 1/4"	31.75	7	12	18			8		16	20	28			7	9	11	41.91
1 5/16"	33.34			18			8	12	16	20	28						
1 3/8"	34.92	6	12	18			8		16	20	28			6	8	11	44.32
1 7/16"	36.51			18			8	12	16	20	28						
1 1/2"	38.10	6	12	18		6	8		16	20	28			6	8	11	47.80
1 9/16"	39.69			18		6	8	12	16	20							
1 5/8"	41.28			18		6	8	12	16	20				5	8		
1 11/16"	42.86			18													
1 3/4"	44.45	5				6	8	12	16	20				5	7	11	53.74
1 13/16"	46.04					6	8	12	16	20							
1 7/8"	47.63					6	8	12	16	20				4 1/2			
1 15/16"	49.21					6	8	12	16	20							
2"	50.80	4 1/2												4 1/2	7	11	59.61
2 1/8"	53.97					6	8	12	16	20							
2 1/4"	57.15	4 1/2				6	8	12	16	20				4	6	11	65.71
2 3/8"	60.32					6	8	12	16	20							
2 1/2"	63.50	4				6	8	12	16	20				4	6	11	75.18
2 5/8"	66.67				4	6	8	12	16	20							
2 3/4"	69.85	4				6	8	12	16	20				3 1/2	6	11	81.53
2 7/8"	73.02				4	6	8	12	16	20							
3"	76.20	4				6	8	12	16	20				3 1/2	5	11	87.88
3 1/8"	79.37				4	6	8	12	16								
3 1/4"	82.55	4				6	8	12	16					3 1/4	5	11	93.98
3 3/8"	85.72				4	6	8	12	16								
3 1/2"	88.90	4				6	8	12	16					3 1/4	4 1/2	11	100.33
3 5/8"	92.07				4	6	8	12	16								
3 3/4"	95.25	4				6	8	12	16					3	4 1/2	11	106.68
3 7/8"	98.42				4	6	8	12	16								
4"	101.60	4				6	8	12	16					3	4 1/2	11	113.03

TABLA DE CONVERSIÓN — CONVERSION TABLE

		Vc m/min															
		1	2	3	4	5	6	8	10	12	15	20	25	30	40	50	60
		min ⁻¹															
Ø d ₁	1	318	637	955	1273	1592	1910	2546	3183	3820	4775	6366	7958	9549	12732	15915	19099
	2	159	318	477	637	796	955	1273	1592	1910	2387	3183	3979	4775	6366	7958	9549
	3	106	212	318	424	531	637	849	1061	1273	1592	2122	2653	3183	4244	5305	6366
	4	80	159	239	318	398	477	637	796	955	1194	1592	1989	2387	3183	3979	4775
	5	64	127	191	255	318	382	509	637	764	955	1273	1592	1910	2546	3183	3820
	6	53	106	159	212	265	318	424	531	637	796	1061	1326	1592	2122	2653	3183
	8	40	80	119	159	199	239	318	398	477	597	796	995	1194	1592	1989	2387
	10	32	64	95	127	159	191	255	318	382	477	637	796	955	1273	1592	1910
	12	27	53	80	106	133	159	212	265	318	398	531	663	796	1061	1326	1592
	14	23	45	68	91	114	136	182	227	273	341	455	568	682	909	1137	1364
	16	20	40	60	80	99	119	159	199	239	298	398	497	597	796	995	1194
	18	18	35	53	71	88	106	141	177	212	265	354	442	531	707	884	1061
	20	16	32	48	64	80	95	127	159	191	239	318	398	477	637	796	955
	25	13	25	38	51	64	76	102	127	153	191	255	318	382	509	637	764
	30	11	21	32	42	53	64	85	106	127	159	212	265	318	424	531	637
	35	9	18	27	36	45	55	73	91	109	136	182	227	273	364	455	546
	40	8	16	24	32	40	48	64	80	95	119	159	199	239	318	398	477
	45	7	14	21	28	35	42	57	71	85	106	141	177	212	283	354	424
	50	6	13	19	25	32	38	51	64	76	95	127	159	191	255	318	382

DIÁMETRO DEL AGUJERO — CORE HOLES

M ISO DIN 14 4H5H (recomendado / recommended)

Ø	P	Ø Núcleo - Core Ø nut		Ø guide line
		Ø mini	Ø maxi	
d ₁	mm			
0.3	0.080	0.223	0.240	0.23
0.35	0.090	0.264	0.286	0.28
0.4	0.100	0.304	0.330	0.32
0.5	0.125	0.380	0.415	0.41
0.6	0.150	0.456	0.502	0.50
0.7	0.175	0.532	0.585	0.58
0.8	0.200	0.608	0.665	0.66
0.9	0.225	0.684	0.745	0.74



MF DIN 13, ISO 261, *4H / 6H

Ø	P	Ø Núcleo - Core Ø nut		Ø guide line
		Ø mini	Ø maxi	
d ₁	mm			
*1.4	0.20	1.183	1.221	1.20
*1.6	0.20	1.383	1.421	1.40
*1.8	0.20	1.583	1.621	1.60
*2	0.20	1.783	1.821	1.80
*2	0.25	1.729	1.774	1.75
*2.2	0.20	1.983	2.021	2.00
*2.2	0.25	1.929	1.974	1.95
*2.3	0.20	2.083	2.121	2.10
*2.3	0.25	2.029	2.074	2.05
*2.5	0.20	2.283	2.321	2.30
*2.5	0.25	2.229	2.274	2.25
2.5	0.35	2.121	2.221	2.15
2.6	0.35	2.221	2.321	2.25
3	0.35	2.621	2.721	2.65
3.5	0.35	3.121	3.221	3.15
4	0.50	3.459	3.599	3.50
4.5	0.50	3.959	4.099	4.00
5	0.50	4.459	4.599	4.50
5.5	0.50	4.959	5.099	5.00
6	0.75	5.188	5.378	5.25
7	0.75	6.188	6.378	6.25
8	0.75	7.188	7.378	7.25
8	1.00	6.917	7.153	7.00
9	0.75	8.188	8.378	8.25
9	1.00	7.917	8.153	8.00
10	0.75	9.188	9.378	9.25
10	1.00	8.917	9.153	9.00
10	1.25	8.647	8.912	8.80
11	0.75	10.188	10.378	10.25
11	1.00	9.917	10.153	10.00
12	1.00	10.917	11.153	11.00
12	1.25	10.647	10.912	10.80
12	1.50	10.376	10.676	10.50
14	1.00	12.917	13.153	13.00
14	1.25	12.647	12.912	12.80
14	1.50	12.376	12.676	12.50
15	1.00	13.917	14.153	14.00
15	1.50	13.376	13.676	13.50
16	1.00	14.917	15.153	15.00
16	1.50	14.376	14.676	14.50
17	1.00	15.917	16.153	16.00
17	1.50	15.376	15.676	15.50
18	1.00	16.917	17.153	17.00
18	1.50	16.376	16.676	16.50
18	2.00	15.835	16.210	16.00
20	1.00	18.917	19.153	19.00
20	1.50	18.376	18.676	18.50
20	2.00	17.835	18.210	18.00
22	1.00	20.917	21.153	21.00
22	1.50	20.376	20.676	20.50
22	2.00	19.835	20.210	20.00
24	1.00	22.917	23.153	23.00
24	1.50	22.376	22.676	22.50
24	2.00	21.835	22.210	22.00
25	1.00	23.917	24.153	24.00
25	1.50	23.376	23.676	23.50
25	2.00	22.835	23.210	23.00



M DIN 13, ISO 261, *5H / 6H

Ø	P	Ø Núcleo - Core Ø nut		Ø guide line
		Ø mini	Ø maxi	
d ₁	mm			
*1	0.25	0.729	0.785	0.75
*1.1	0.25	0.829	0.885	0.85
*1.2	0.25	0.929	0.985	0.95
*1.4	0.30	1.075	1.142	1.10
1.6	0.35	1.221	1.321	1.25
1.7	0.35	1.321	1.421	1.35
1.8	0.35	1.421	1.521	1.45
2	0.40	1.567	1.679	1.60
2.2	0.45	1.713	1.838	1.75
2.3	0.40	1.867	1.979	1.90
2.5	0.45	2.013	2.138	2.05
2.6	0.45	2.113	2.238	2.15
3	0.50	2.459	2.599	2.50
3.5	0.60	2.850	3.010	2.90
4	0.70	3.242	3.422	3.30
4.5	0.75	3.688	3.878	3.75
5	0.80	4.134	4.334	4.20
6	1.00	4.917	5.153	5.00
7	1.00	5.917	6.153	6.00
8	1.25	6.647	6.912	6.80
9	1.25	7.647	7.912	7.80
10	1.50	8.376	8.676	8.50
11	1.50	9.376	9.676	9.50
12	1.75	10.106	10.441	10.20
14	2.00	11.835	12.210	12.00
16	2.00	13.835	14.210	14.00
18	2.50	15.294	15.744	15.50
20	2.50	17.294	17.744	17.50
22	2.50	19.294	19.744	19.50
24	3.00	20.752	21.252	21.00
27	3.00	23.752	24.252	24.00
30	3.50	26.211	26.771	26.50
33	3.50	29.211	29.771	29.50
36	4.00	31.670	32.270	32.00
39	4.00	34.670	35.270	35.00
42	4.50	37.129	37.799	37.50
45	4.50	40.129	40.799	40.50
48	5.00	42.587	43.297	43.00
52	5.00	46.587	47.297	47.00
56	5.50	50.046	50.796	50.50



DIÁMETRO DEL AGUJERO — CORE HOLES

MF DIN 13, ISO 261, 6H

Ø	P	Ø Núcleo - Core Ø nut		Ø guide line
		Ø mini	Ø maxi	
d ₁	mm			
27	1.50	25.376	25.676	25.50
27	2.00	24.835	25.210	25.00
28	1.00	26.917	27.153	27.00
28	1.50	26.376	26.676	26.50
28	2.00	25.835	26.210	26.00
30	1.00	28.917	29.153	29.00
30	1.50	28.376	28.676	28.50
30	2.00	27.835	28.210	28.00
32	1.50	30.376	30.676	30.50
32	2.00	29.835	30.210	30.00
33	1.50	31.376	31.676	31.50
33	2.00	30.835	31.210	31.00
35	1.50	33.376	33.676	33.50
36	1.50	34.376	34.676	34.50
36	2.00	33.835	34.210	34.00
36	3.00	32.752	33.252	33.00
39	1.50	37.376	37.676	37.50
39	2.00	36.835	37.210	37.00
39	3.00	35.752	36.252	36.00
40	1.50	38.376	38.676	38.50
40	2.00	37.835	38.210	38.00
40	3.00	36.752	37.252	37.00
42	1.50	40.376	40.676	40.50
42	2.00	39.835	40.210	40.00
42	3.00	38.752	39.252	39.00
45	1.50	43.376	43.676	43.50
45	2.00	42.835	43.210	43.00
45	3.00	41.752	42.252	42.00
48	1.50	46.376	46.676	46.50
48	2.00	45.835	46.210	46.00
48	3.00	44.752	45.252	45.00
50	1.50	48.376	48.676	48.50
50	2.00	47.835	48.210	48.00
50	3.00	46.752	47.252	47.00
52	1.50	50.376	50.676	50.50
52	2.00	49.835	50.210	50.00
52	3.00	48.752	49.252	49.00
55	2.00	52.835	53.210	53.00
60	2.00	57.835	58.210	58.00

MF EN 60423:1994, 7H

Ø	P	Ø Núcleo - Core Ø nut		Ø guide line
		Ø mini	Ø maxi	
d ₁	mm			
8	1.00	6.917	7.217	7.00
10	1.00	8.917	9.217	9.00
12	1.50	10.376	10.751	10.50
16	1.50	14.376	14.751	14.50
20	1.50	18.376	18.751	18.50
25	1.50	23.376	23.751	23.50
32	1.50	30.376	30.751	30.50
40	1.50	38.376	38.751	38.50
63	1.50	61.376	61.751	61.50

UNC ASME B1.1, 2B

Ø"	P	P	Ø Núcleo - Core Ø nut		Ø guide line
			Ø mini	Ø maxi	
d ₁	TPI	mm			
1	64	0.397	1.425	1.582	1.45
2	56	0.454	1.695	1.871	1.75
3	48	0.529	1.941	2.146	2.00
4	40	0.635	2.157	2.385	2.25
5	40	0.635	2.487	2.697	2.55
6	32	0.794	2.642	2.895	2.75
8	32	0.794	3.302	3.530	3.40
10	24	1.058	3.683	3.962	3.80
12	24	1.058	4.344	4.597	4.40
1/4"	20	1.270	4.979	5.257	5.10
5/16"	18	1.411	6.401	6.731	6.50
3/8"	16	1.588	7.798	8.153	8.00
7/16"	14	1.814	9.144	9.550	9.30
1/2"	13	1.954	10.592	11.023	10.80
9/16"	12	2.117	11.989	12.446	12.20
5/8"	11	2.309	13.386	13.868	13.60
3/4"	10	2.540	16.307	16.840	16.60
7/8"	9	2.822	19.177	19.761	19.50
1"	8	3.175	21.971	22.606	22.30
1 1/8"	7	3.629	24.638	25.349	25.00
1 1/4"	7	3.629	27.813	28.524	28.20
1 3/8"	6	4.233	30.353	31.115	30.80
1 1/2"	6	4.233	33.528	34.290	34.00
1 3/4"	5	5.080	38.964	39.827	39.50
2"	4.5	5.644	44.679	45.593	45.30

UNJC ISO 3161:1999, 3B

Ø"	P	P	Ø Núcleo - Core Ø nut		Ø guide line
			Ø mini	Ø maxi	
d ₁	TPI	mm			
4	40	0.635	2.228	2.393	2.30
5	40	0.635	2.558	2.723	2.60
6	32	0.794	2.733	2.939	2.80
8	32	0.794	3.393	3.599	3.45
10	24	1.058	3.795	4.064	3.90
12	24	1.058	4.455	4.704	4.55
1/4"	20	1.270	5.113	5.387	5.20
5/16"	18	1.411	6.563	6.833	6.70
3/8"	16	1.588	7.978	8.255	8.10
7/16"	14	1.814	9.347	9.639	9.40
1/2"	13	1.954	10.798	11.095	10.90
9/16"	12	2.117	12.228	12.482	12.40
5/8"	11	2.309	13.627	13.904	13.80
3/4"	10	2.540	16.576	16.881	16.70

DIÁMETRO DEL AGUJERO — CORE HOLES

UNF ASME B1.1, 2B

Ø"	P	P	Ø Núcleo - Core Ø nut		Ø guide line
			Ø mini	Ø maxi	
d ₁	TPI	mm			
0	80	0.318	1.182	1.305	1.20
1	72	0.353	1.474	1.612	1.50
2	64	0.397	1.756	1.912	1.80
3	56	0.454	2.025	2.197	2.10
4	48	0.529	2.271	2.458	2.35
5	44	0.577	2.551	2.740	2.60
6	40	0.635	2.820	3.022	2.90
8	36	0.706	3.404	3.606	3.50
10	32	0.794	3.963	4.165	4.05
12	28	0.907	4.496	4.724	4.60
1/4"	28	0.907	5.360	5.588	5.50
5/16"	24	1.058	6.782	7.035	6.90
3/8"	24	1.058	8.382	8.636	8.50
7/16"	20	1.270	9.729	10.033	9.80
1/2"	20	1.270	11.329	11.607	11.40
9/16"	18	1.411	12.751	13.081	12.90
5/8"	18	1.411	14.351	14.681	14.50
3/4"	16	1.588	17.323	17.678	17.50
7/8"	14	1.814	20.270	20.675	20.40
1"	12	2.117	23.114	23.571	23.30
1 1/8"	12	2.117	26.289	26.746	26.50
1 1/4"	12	2.117	29.464	29.921	29.70
1 3/8"	12	2.117	32.639	33.096	32.80
1 1/2"	12	2.117	35.814	36.271	36.00

UNJF ISO 3161:1999, 3B

Ø"	P	P	Ø Núcleo - Core Ø nut		Ø guide line
			Ø mini	Ø maxi	
d ₁	TPI	mm			
0	80	0.318	1.217	1.298	1.25
1	72	0.353	1.511	1.603	1.55
2	64	0.397	1.798	1.902	1.85
3	56	0.454	2.073	2.189	2.10
4	48	0.529	2.329	2.466	2.35
5	44	0.577	2.614	2.764	2.65
6	40	0.635	2.888	3.053	2.95
8	36	0.706	3.480	3.663	3.55
10	32	0.794	4.054	4.255	4.10
12	28	0.907	4.602	4.816	4.70
1/4"	28	0.907	5.466	5.662	5.55
5/16"	24	1.058	6.906	7.109	7.00
3/8"	24	1.058	8.494	8.679	8.60
7/16"	20	1.270	9.876	10.084	10.00
1/2"	20	1.270	11.463	11.661	11.55
9/16"	18	1.411	12.913	13.122	13.05
5/8"	18	1.411	14.501	14.702	14.60
3/4"	16	1.588	17.506	17.722	17.60
7/8"	14	1.814	20.460	20.706	20.60
1"	12	2.117	23.340	23.594	23.50

UNEF ASME B1.1, 2B

Ø"	P	P	Ø Núcleo - Core Ø nut		Ø guide line
			Ø mini	Ø maxi	
d ₁	TPI	mm			
12	32	0.794	4.623	4.826	4.70
1/4"	32	0.794	5.487	5.689	5.60
5/16"	32	0.794	7.087	7.264	7.20
3/8"	32	0.794	8.662	8.864	8.75
7/16"	28	0.907	10.135	10.337	10.25
1/2"	28	0.907	11.710	11.938	11.85
9/16"	24	1.058	13.132	13.385	13.20
5/8"	24	1.058	14.732	14.986	14.80
11/16"	24	1.058	16.307	16.560	16.40
3/4"	20	1.270	17.679	17.957	17.80
13/16"	20	1.270	19.254	19.558	19.40
7/8"	20	1.270	20.854	21.132	21.00
1"	20	1.270	24.029	24.307	24.10

UN ASME B1.1, 2B

Ø"	P	P	Ø Núcleo - Core Ø nut		Ø guide line
			Ø mini	Ø maxi	
d ₁	TPI	mm			
5/16"	20	1.270	6.554	6.858	6.70
3/8"	20	1.270	8.154	8.432	8.30
9/16"	20	1.270	12.904	13.208	13.00
5/8"	20	1.270	14.504	14.782	14.60
1 1/8"	8	3.175	25.146	25.781	25.50
1 1/4"	8	3.175	28.321	28.956	28.70
1 3/8"	8	3.175	31.496	32.131	31.80
1 1/2"	8	3.175	34.671	35.306	35.00
1 5/8"	8	3.175	37.846	38.481	38.20
1 3/4"	8	3.175	41.021	41.656	41.40
1 7/8"	8	3.175	44.196	44.831	44.50
2"	8	3.175	47.371	48.006	47.70
2 1/4"	8	3.175	53.721	54.356	54.10
2 1/2"	8	3.175	60.071	60.706	60.40

UNS ASME B1.1, 2B

Ø"	P	P	Ø Núcleo - Core Ø nut		Ø guide line
			Ø mini	Ø maxi	
d ₁	TPI	mm			
10	36	0.706	4.064	4.216	4.10
10	40	0.635	4.141	4.292	4.20
10	56	0.454	4.344	4.445	4.40
1/4"	36	0.706	5.588	5.740	5.65
1/4"	40	0.635	5.665	5.816	5.70
1/4"	48	0.529	5.766	5.892	5.80
1/4"	56	0.454	5.868	5.969	5.90
5/16"	36	0.706	7.163	7.340	7.25
3/8"	36	0.706	8.763	8.940	8.80
7/16"	24	1.058	9.957	10.210	10.00
1/2"	24	1.058	11.557	11.811	11.60
1"	14	1.814	23.445	23.825	23.60

DIÁMETRO DEL AGUJERO — CORE HOLES

G (BSP) DIN EN ISO 228

Ø"	P	P	Ø Núcleo - Core Ø nut		Ø guide line
			Ø mini	Ø maxi	
d _i	TPI	mm			
1/16"	28	0.907	6.561	6.843	6.75
1/8"	28	0.907	8.566	8.848	8.75
1/4"	19	1.337	11.445	11.890	11.60
3/8"	19	1.337	14.950	15.395	15.20
1/2"	14	1.814	18.631	19.172	18.90
5/8"	14	1.814	20.587	21.128	20.90
3/4"	14	1.814	24.117	24.658	24.40
7/8"	14	1.814	27.877	28.418	28.20
1"	11	2.309	30.291	30.931	30.70
1 1/8"	11	2.309	34.939	35.579	35.30
1 1/4"	11	2.309	38.952	39.592	39.30
1 3/8"	11	2.309	41.365	42.005	41.80
1 1/2"	11	2.309	44.845	45.485	45.20
1 3/4"	11	2.309	50.788	51.428	51.20
2"	11	2.309	56.656	57.296	57.00
2 1/4"	11	2.309	62.752	63.392	63.10
2 1/2"	11	2.309	72.226	72.866	72.60
3"	11	2.309	84.926	85.566	85.30

W (BSW) BS 84, (DIN 11 - 1970)

Ø"	P	P	Ø Núcleo - Core Ø nut		Ø guide line
			Ø mini	Ø maxi	
d _i	TPI	mm			
(3/32")	48				1.80
1/8"	40	0.635	2.362	2.591	2.50
(5/32")	32				3.10
3/16"	24	1.058	3.406	3.744	3.60
(7/32")	24				4.40
1/4"	20	1.270	4.724	5.156	4.90
5/16"	18	1.411	6.129	6.588	6.40
3/8"	16	1.588	7.493	7.988	7.70
7/16"	14	1.814	8.791	9.332	9.10
1/2"	12	2.117	9.987	10.589	10.30
5/8"	11	2.309	12.918	13.558	13.30
3/4"	10	2.540	15.799	16.484	16.20
7/8"	9	2.822	18.613	19.355	19.25
1"	8	3.175	21.336	22.149	21.90

PG DIN 40430

Ø	P	P	Ø Núcleo - Core Ø nut		Ø guide line
			Ø mini	Ø maxi	
d _i	TPI	mm			
7	20	1.270	11.28	11.43	11.35
9	18	1.411	13.86	14.01	13.90
11	18	1.411	17.26	17.41	17.30
13.5	18	1.411	19.06	19.21	19.10
16	18	1.411	21.16	21.31	21.20
21	16	1.588	26.78	27.03	26.80
29	16	1.588	35.48	35.73	35.50
36	16	1.588	45.48	45.73	45.50
42	16	1.588	52.48	52.73	52.50
48	16	1.588	57.78	58.03	57.80

TR ISO 2901-2904, DIN 103, 7H

Ø	P	Ø Núcleo - Core Ø nut		Ø guide line
		Ø mini	Ø maxi	
d _i	mm			
10	2	8	8.236	8.20
12	3	9	9.315	9.25
14	3	11	11.315	11.25
16	4	12	12.375	12.25
18	4	14	14.375	14.25
20	4	16	16.375	16.25
22	5	17	17.450	17.25
24	5	19	19.450	19.25
26	5	21	21.450	21.25
28	5	23	23.450	23.25
30	6	24	24.500	24.25
32	6	26	26.500	26.25

S NIHS 06-10, 3G5H (Tol. estándar - standard)

Ø	P	Ø Núcleo - Core Ø nut		Ø guide line
		Ø mini	Ø maxi	
d _i	mm			
0.3	0.080	0.223	0.240	0.23
0.35	0.090	0.264	0.286	0.28
0.4	0.100	0.304	0.330	0.32
0.5	0.125	0.380	0.415	0.41
0.6	0.150	0.456	0.502	0.50
0.7	0.175	0.532	0.585	0.58
0.8	0.200	0.608	0.665	0.66
0.9	0.225	0.684	0.745	0.74
1	0.250	0.760	0.825	0.82
1.2	0.250	0.960	1.025	1.02
1.4	0.300	1.112	1.185	1.18

SF Fine Thread NIHS 06-10, 3G5H (Tol. estándar - standard tol.)

Ø	P	Ø Núcleo - Core Ø nut		Ø guide line
		Ø mini	Ø maxi	
d _i	mm			
1.4	0.200	1.208	1.265	1.26
1.6	0.200	1.408	1.465	1.46
1.8	0.200	1.608	1.665	1.66
2	0.200	1.808	1.865	1.86
2.2	0.200	2.008	2.065	2.06
2.2	0.250	1.960	2.025	2.02
2.5	0.200	2.308	2.365	2.36
2.5	0.250	2.260	2.325	2.32

SL Safelock SL 15-01

Ø	P	Ø Núcleo - Core Ø nut		Ø guide line
		Ø mini	Ø maxi	
d _i	mm			
0.3	0.060	0.264	0.278	0.27
0.35	0.060	0.314	0.328	0.32
0.4	0.080	0.356	0.372	0.36
0.5	0.100	0.448	0.466	0.46
0.6	0.125	0.538	0.559	0.55
0.7	0.150	0.628	0.651	0.64
0.8	0.150	0.728	0.751	0.74
0.9	0.175	0.818	0.844	0.83
1	0.200	0.908	0.936	0.92
1.2	0.200	1.108	1.136	1.12
1.4	0.250	1.288	1.321	1.30

DIÁMETRO DE TORNEADO — TURNED DIAMETERS

M DIN 13, ISO 261, *6h / 6g

Ø	P	Ø Exterior Thread outside Ø		Ø guide line
		Ø mini	Ø maxi	
d ₁	mm			
*1	0.25	0.933	1.000	0.97
*1.1	0.25	1.033	1.100	1.07
*1.2	0.25	1.133	1.200	1.17
*1.4	0.30	1.325	1.400	1.36
1.6	0.35	1.496	1.581	1.54
1.7	0.35	1.596	1.681	1.64
1.8	0.35	1.696	1.781	1.74
2	0.40	1.886	1.981	1.93
2.2	0.45	2.080	2.180	2.13
2.3	0.40	2.186	2.300	2.23
2.5	0.45	2.380	2.480	2.43
2.6	0.45	2.480	2.600	2.53
3	0.50	2.874	2.980	2.92
3.5	0.60	3.354	3.479	3.41
4	0.70	3.838	3.978	3.91
4.5	0.75	4.338	4.478	4.40
5	0.80	4.826	4.976	4.90
6	1.00	5.794	5.974	5.88
7	1.00	6.794	6.974	6.88
8	1.25	7.760	7.972	7.87
9	1.25	8.760	8.972	8.87
10	1.50	9.732	9.968	9.85
11	1.50	10.732	10.968	10.85
12	1.75	11.701	11.966	11.83
14	2.00	13.682	13.962	13.82
16	2.00	15.682	15.962	15.82
18	2.50	17.623	17.958	17.79
20	2.50	19.623	19.958	19.79
22	2.50	21.623	21.958	21.79
24	3.00	23.577	23.952	23.76
27	3.00	26.577	26.952	26.76
30	3.50	29.522	29.947	29.73
33	3.50	32.522	32.947	32.73
36	4.00	35.465	35.940	35.70
39	4.00	38.465	38.940	38.70
42	4.50	41.437	41.937	41.69
45	4.50	44.437	44.937	44.69
48	5.00	47.399	47.929	47.66
52	5.00	51.399	51.929	51.66
56	5.50	55.365	55.925	55.65

MF DIN 13, ISO 261, 6g

Ø	P	Ø Exterior Thread outside Ø		Ø guide line
		Ø mini	Ø maxi	
d ₁	mm			
8	1.00	7.794	7.974	7.88
9	0.75	8.838	8.978	8.90
9	1.00	8.794	8.974	8.88
10	0.75	9.838	9.978	9.90
10	1.00	9.794	9.974	9.88
10	1.25	9.760	9.972	9.86
11	0.75	10.838	10.978	10.90
11	1.00	10.794	10.974	10.88
12	1.00	11.794	11.974	11.88
12	1.25	11.760	11.972	11.86
12	1.50	11.732	11.968	11.85
14	1.00	13.794	13.974	13.88
14	1.25	13.760	13.972	13.86
14	1.50	13.732	13.968	13.85
15	1.00	14.794	14.974	14.88
15	1.50	14.732	14.968	14.85
16	1.00	15.794	15.974	15.88
16	1.50	15.732	15.968	15.85
17	1.00	16.794	16.974	16.88
17	1.50	16.732	16.968	16.85
18	1.00	17.794	17.974	17.88
18	1.50	17.732	17.968	17.85
18	2.00	17.682	17.962	17.82
20	1.00	19.794	19.974	19.88
20	1.50	19.732	19.968	19.85
20	2.00	19.682	19.962	19.82
22	1.00	21.794	21.974	21.88
22	1.50	21.732	21.968	21.85
22	2.00	21.682	21.962	21.82
24	1.00	23.794	23.974	23.88
24	1.50	23.732	23.968	23.85
24	2.00	23.682	23.962	23.82
25	1.00	24.794	24.974	24.88
25	1.50	24.732	24.968	24.85
25	2.00	24.682	24.962	24.82
27	1.00	26.794	26.974	26.88
27	1.50	26.732	26.968	26.85
27	2.00	26.682	26.962	26.82
28	1.00	27.794	27.974	27.88
28	1.50	27.732	27.968	27.85
28	2.00	27.682	27.962	27.82
30	1.00	29.794	29.974	29.88
30	1.50	29.732	29.968	29.85
30	2.00	29.682	29.962	29.82
30	3.00	29.577	29.952	29.76
32	1.50	31.732	31.968	31.85
32	2.00	31.682	31.962	31.82
33	1.50	32.732	32.968	32.85
33	2.00	32.682	32.962	32.82
33	3.00	32.577	32.952	32.76
35	1.50	34.732	34.968	34.85
36	1.50	35.732	35.968	35.85
36	2.00	35.682	35.962	35.82
36	3.00	35.577	35.952	35.76
39	1.50	38.732	38.968	38.85
39	2.00	38.682	38.962	38.82
39	3.00	38.577	38.952	38.76

MF DIN 13, ISO 261, 6g

Ø	P	Ø Exterior Thread outside Ø		Ø guide line
		Ø mini	Ø maxi	
d ₁	mm			
2.5	0.35	2.396	2.481	2.44
3	0.35	2.896	2.981	2.94
3.5	0.35	3.396	3.481	3.44
4	0.50	3.874	3.980	3.93
4.5	0.50	4.374	4.480	4.43
5	0.50	4.874	4.980	4.93
5.5	0.50	5.374	5.480	5.43
6	0.75	5.838	5.978	5.90
7	0.75	6.838	6.978	6.90
8	0.75	7.838	7.978	7.90

DIÁMETRO DE TORNEADO — TURNED DIAMETERS

MF DIN 13, ISO 261, 6g

Ø	P	Ø Exterior Thread outside Ø		Ø guide line
		Ø mini	Ø maxi	
d ₁	mm			
40	1.50	39.732	39.968	39.85
40	2.00	39.682	39.962	39.82
40	3.00	39.577	39.952	39.76
42	1.50	41.732	41.968	41.85
42	2.00	41.682	41.962	41.82
42	3.00	41.577	41.952	41.76
45	1.50	44.732	44.968	44.85
45	2.00	44.682	44.962	44.82
45	3.00	44.577	44.952	44.76
48	1.50	47.732	47.968	47.85
48	2.00	47.682	47.962	47.82
48	3.00	47.577	47.952	47.76
50	1.50	49.732	49.968	49.85
50	2.00	49.682	49.962	49.82
50	3.00	49.577	49.952	49.76
52	1.50	51.732	51.968	51.85
52	2.00	51.682	51.962	51.82
52	3.00	51.577	51.952	51.76
52	4.00	51.465	51.940	51.70



UNF ASME B1.1, 2A

Ø"	P	P	Ø Exterior Thread outside Ø		Ø guide line
			Ø mini	Ø maxi	
d ₁	TPI	mm			
0	80	0.318	1.431	1.511	1.47
1	72	0.353	1.751	1.838	1.79
2	64	0.397	2.073	2.169	2.12
3	56	0.454	2.393	2.496	2.44
4	48	0.529	2.713	2.827	2.77
5	44	0.577	3.036	3.157	3.10
6	40	0.635	3.356	3.484	3.42
8	36	0.706	4.006	4.145	4.08
10	32	0.794	4.651	4.803	4.73
12	28	0.907	5.296	5.461	5.38
1/4"	28	0.907	6.160	6.324	6.24
5/16"	24	1.058	7.727	7.909	7.82
3/8"	24	1.058	9.315	9.497	9.41
7/16"	20	1.270	10.874	11.079	10.98
1/2"	20	1.270	12.462	12.666	12.56
9/16"	18	1.411	14.031	14.251	14.14
5/8"	18	1.411	15.619	15.839	15.73
3/4"	16	1.588	18.774	19.011	18.89
7/8"	14	1.814	21.923	22.184	22.05
1"	12	2.117	25.065	25.354	25.21
1 1/8"	12	2.117	28.240	28.529	28.38
1 1/4"	12	2.117	31.415	31.704	31.56
1 3/8"	12	2.117	34.588	34.876	34.73
1 1/2"	12	2.117	37.763	38.051	37.91



UNC ASME B1.1, 2A

Ø"	P	P	Ø Exterior Thread outside Ø		Ø guide line
			Ø mini	Ø maxi	
d ₁	TPI	mm			
1	64	0.397	1.743	1.838	1.79
2	56	0.454	2.066	2.169	2.12
3	48	0.529	2.383	2.496	2.44
4	40	0.635	2.695	2.824	2.76
5	40	0.635	3.026	3.154	3.09
6	32	0.794	3.333	3.484	3.41
8	32	0.794	3.991	4.142	4.07
10	24	1.058	4.618	4.800	4.71
12	24	1.058	5.279	5.461	5.37
1/4"	20	1.270	6.117	6.322	6.22
5/16"	18	1.411	7.687	7.907	7.80
3/8"	16	1.588	9.254	9.491	9.37
7/16"	14	1.814	10.816	11.076	10.95
1/2"	13	1.954	12.386	12.661	12.52
9/16"	12	2.117	13.958	14.246	14.10
5/8"	11	2.309	15.528	15.834	15.68
3/4"	10	2.540	18.677	19.004	18.84
7/8"	9	2.822	21.824	22.176	22.00
1"	8	3.175	24.969	25.349	25.16
1 1/8"	7	3.629	28.103	28.519	28.31
1 1/4"	7	3.629	31.278	31.694	31.49
1 3/8"	6	4.233	34.402	34.864	34.63
1 1/2"	6	4.233	37.577	38.039	37.81
1 3/4"	5	5.080	43.860	44.381	44.12
2"	4.5	5.644	50.168	50.726	50.45
2 1/4"	4.5	5.644	56.518	57.076	56.80
2 1/2"	4	6.350	62.817	63.421	63.12
2 3/4"	4	6.350	69.165	69.768	69.47
3"	4	6.350	75.515	76.118	75.82
3 1/4"	4	6.350	81.862	82.466	82.16
3 1/2"	4	6.350	88.212	88.816	88.51
3 3/4"	4	6.350	94.560	95.163	94.86
4"	4	6.350	100.910	101.513	101.21



UNEF ASME B1.1, 2A

Ø"	P	P	Ø Exterior Thread outside Ø		Ø guide line
			Ø mini	Ø maxi	
d ₁	TPI	mm			
12	32	0.794	5.312	5.463	5.39
1/4"	32	0.794	6.173	6.324	6.25
5/16"	32	0.794	7.760	7.912	7.84
3/8"	32	0.794	9.348	9.499	9.42
7/16"	28	0.907	10.920	11.084	11.00
1/2"	28	0.907	12.507	12.672	12.59
9/16"	24	1.058	14.075	14.257	14.17
5/8"	24	1.058	15.662	15.844	15.75
11/16"	24	1.058	17.250	17.432	17.34
3/4"	20	1.270	18.812	19.016	18.91
13/16"	20	1.270	20.339	20.604	20.50
7/8"	20	1.270	21.987	22.191	22.09
15/16"	20	1.270	23.572	23.776	23.67
1"	20	1.270	25.159	25.364	25.26
1 1/8"	18	1.411	28.319	28.539	28.43
1 1/4"	18	1.411	31.491	31.711	31.60
1 1/2"	18	1.411	37.841	38.061	37.95



UN ASME B1.1, 2A

Ø"	P	P	Ø Exterior Thread outside Ø		Ø guide line
			Ø mini	Ø maxi	
d ₁	TPI	mm			
5/16"	20	1.270	7.702	7.907	7.80
3/8"	20	1.270	9.289	9.494	9.39
9/16"	20	1.270	14.049	14.254	14.15
5/8"	20	1.270	15.637	15.841	15.74



DIÁMETRO DE TORNEADO — TURNED DIAMETERS

UN ASME B1.1, 2A

Ø"	P	P	Ø Exterior Thread outside Ø		Ø guide line
			Ø mini	Ø maxi	
d _i	TPI	mm			
1 1/8"	8	3.175	28.141	28.521	28.33
1 1/4"	8	3.175	31.316	31.696	31.51
1 3/8"	8	3.175	34.489	34.869	34.68
1 1/2"	8	3.175	37.664	38.044	37.85
1 5/8"	8	3.175	40.839	41.219	41.03
1 3/4"	8	3.175	44.011	44.391	44.20
1 7/8"	8	3.175	47.186	47.566	47.38
2"	8	3.175	50.361	50.741	50.55
2 1/4"	8	3.175	56.709	57.089	56.90
2 1/2"	8	3.175	63.059	63.439	63.25
2 3/4"	8	3.175	69.406	69.786	69.60
3"	8	3.175	75.753	76.133	75.94

UNS ASME B1.1, 2A

Ø"	P	P	Ø Exterior Thread outside Ø		Ø guide line
			Ø mini	Ø maxi	
d _i	TPI	mm			
10	36	0.706	4.664	4.803	4.73
10	40	0.635	4.674	4.803	4.74
10	56	0.454	4.705	4.808	4.76
1/4"	36	0.706	6.188	6.327	6.26
1/4"	40	0.635	6.198	6.327	6.26
1/4"	48	0.529	6.216	6.329	6.27
1/4"	56	0.454	6.226	6.329	6.28
5/16"	36	0.706	7.775	7.914	7.84
3/8"	36	0.706	9.360	9.499	9.43
7/16"	24	1.058	10.902	11.084	10.99
1/2"	24	1.058	12.487	12.669	12.58
1"	14	1.814	25.096	25.356	25.23

G (BSP) DIN EN ISO 228

Ø"	P	P	Ø Exterior Thread outside Ø		Ø guide line
			Ø mini	Ø maxi	
d _i	TPI	mm			
1/16"	28	0.907	7.509	7.723	7.62
1/8"	28	0.907	9.514	9.728	9.62
1/4"	19	1.337	12.907	13.157	13.03
3/8"	19	1.337	16.412	16.662	16.54
1/2"	14	1.814	20.671	20.955	20.81
5/8"	14	1.814	22.627	22.911	22.77
3/4"	14	1.814	26.157	26.441	26.30
7/8"	14	1.814	29.917	30.201	30.06
1"	11	2.309	32.889	33.249	33.07
1 1/8"	11	2.309	37.537	37.897	37.72
1 1/4"	11	2.309	41.550	41.910	41.73
1 3/8"	11	2.309	43.963	44.323	44.14
1 1/2"	11	2.309	47.443	47.803	47.62
1 3/4"	11	2.309	53.386	53.746	53.57
2"	11	2.309	59.254	59.614	59.43
2 1/4"	11	2.309	65.276	65.710	65.49
2 1/2"	11	2.309	74.750	75.184	74.97
2 3/4"	11	2.309	81.100	81.534	81.32
3"	11	2.309	87.450	87.884	87.67
3 1/2"	11	2.309	99.896	100.330	100.11

W (BSW) BS 84

Ø"	P	P	Ø Exterior Thread outside Ø		Ø guide line
			Ø mini	Ø maxi	
d _i	TPI	mm			
1/4"	20	1.270	6.165	6.319	6.24
5/16"	18	1.411	7.737	7.904	7.82
3/8"	16	1.588	9.312	9.489	9.40
7/16"	14	1.814	10.884	11.074	10.98
1/2"	12	2.117	12.456	12.662	12.56
5/8"	11	2.309	15.613	15.832	15.72
3/4"	10	2.540	18.771	19.004	18.89
7/8"	9	2.822	21.979	22.225	22.10
1"	8	3.175	25.138	25.400	25.27
1 1/8"	7	3.629	28.296	28.575	28.44
1 1/4"	7	3.629	31.465	31.750	31.61
1 1/2"	6	4.233	37.793	38.100	37.95
1 3/4"	5	5.080	44.117	44.450	44.28
2"	4.5	5.644	50.449	50.800	50.62
2 1/4"	4	6.350	56.779	57.150	56.96
2 1/2"	4	6.350	63.119	63.500	63.31

PG DIN 40430

Ø	P	P	Ø Exterior Thread outside Ø		Ø guide line
			Ø mini	Ø maxi	
d _i	TPI	mm			
7	20	1.270	12.3	12.5	12.40
9	18	1.411	15.0	15.2	15.10
11	18	1.411	18.4	18.6	18.50
13.5	18	1.411	20.2	20.4	20.30
16	18	1.411	22.3	22.5	22.40
21	16	1.588	28.0	28.3	28.15
29	16	1.588	36.7	37.0	36.85
36	16	1.588	46.7	47.0	46.85
42	16	1.588	53.7	54.0	53.85
48	16	1.588	59.0	59.3	59.15

TR ISO 2901-2904, DIN 103, 7e

Ø	P	Ø Exterior Thread outside Ø		Ø guide line
		Ø mini	Ø maxi	
d _i	mm			
10	2	9.820	10.000	9.91
12	3	11.764	12.000	11.88
14	3	13.764	14.000	13.88
16	4	15.700	16.000	15.85
18	4	17.700	18.000	17.85
20	4	19.700	20.000	19.85
22	5	21.665	22.000	21.83
24	5	23.665	24.000	23.83
26	5	25.665	26.000	25.83
28	5	27.665	28.000	27.83
30	6	29.625	30.000	29.81
32	6	31.625	32.000	31.81

Enquiry <input type="checkbox"/>	Test result <input type="checkbox"/>	Complaint <input type="checkbox"/>
Agency : _____		Contact : _____
Customer : _____		E-mail : _____
Phone or fax : _____		Date : _____
<hr/>		
1. Tool type : _____		
Tool Ø : _____		Pitch : _____
Serie : _____		Coating : _____
<hr/>		
2. Material group : _____		
Material N° : _____		Hardness : _____ N/mm ² /HB/HRC
Norm : _____		Elongation : _____ %
<hr/>		
3. Thread : <input type="checkbox"/> internal <input type="checkbox"/> external Hole : <input type="checkbox"/> blind <input type="checkbox"/> through		
Threaded length : _____ mm		
Core hole Ø : _____		Depth : _____ mm
Counter-bore Ø : _____		Depth : _____ mm
<hr/>		
4. Cutting speed (V_c) : _____ m/min _____ l/min		
Feed (f) : _____ mm/rev.		Feed (f_z) : _____ mm/tooth
<hr/>		
5. Machine : _____ <input type="checkbox"/> internal coolant		
Working position : <input type="checkbox"/> horizontal Tool attachment : <input type="checkbox"/> collet <input type="checkbox"/> Weldon / Whistle Notch		
<input type="checkbox"/> vertical		<input type="checkbox"/> hydraulic chuck <input type="checkbox"/> hot / cold shrunk
<hr/>		
6. Lubricant : <input type="checkbox"/> emulsion <input type="checkbox"/> oil <input type="checkbox"/> air <input type="checkbox"/> mist		
Product : _____		
<hr/>		
7. Tool change reason : <input type="checkbox"/> tool wear <input type="checkbox"/> tool breakage		
<input type="checkbox"/> incorrect threading (inspected with gauge)		<input type="checkbox"/> programme error
<hr/>		
8. Efficiency comparison		
Tool under test : _____		
Performance and observations : _____		

<hr/>		
Remarks : _____		

CONDICIONES DE ENTREGA

Pedidos	<p>Los pedidos que no puedan ser entregados de stock serán confirmados. Los artículos que ya no están en stock, pero todavía mencionados en el catálogo serán considerados como ejecuciones especiales y facturados como tales. Toda anulación de pedido debe ser aceptada por las dos partes y formulada por escrito.</p>
Ofertas y confirmaciones de pedidos	<p>Dado el constante desarrollo en la materia, las descripciones que figuran en nuestras ofertas, los documentos que las acompañan, las indicaciones de peso, medidas, ilustraciones y dibujos tienen carácter de indicaciones aproximadas. Estas informaciones tienen carácter obligatorio solamente en caso que éste último se especifique expresamente.</p>
Precios	<p>Nuestros precios implican entregas libres de gastos salida de fábrica o punto de venta y no comprenden gastos de embalaje, flete, portes ni seguros. En caso de aumento de precios, nos reservamos el derecho de facturar las herramientas confirmadas a los nuevos precios.</p>
Forma de pago	<p>Las facturas se pagan a los 30 días. En caso de incumplimiento de dicho plazo, un interés moratorio, a contar desde el vencimiento y calculado sobre la base de la tasa de descuento del momento, podrá exigirse. Los gastos de reembolso, de emisión de letras, etc., son a cargo del comprador.</p>
Reserva de propiedad	<p>El material queda de nuestra entera propiedad hasta el pago íntegro del precio total, gastos complementarios incluidos.</p>
Envíos	<p>Las mercancías se remiten por cuenta y riesgo del cliente.</p>
Plazos de entrega	<p>Los plazos de entrega se calculan lo más justo posible pero a título indicativo. En caso de demora, ninguna reclamación será aceptada ni los pedidos podrán cancelarse por este motivo.</p>
Fabricaciones especiales	<p>Por razones técnicas de fabricación, nos reservamos el derecho de entregar un 15% de más o de menos sobre las cantidades de herramientas especiales pedidas, o en pequeñas cantidades por 1 o 2 piezas.</p>
Garantía	<p>Las herramientas reconocidas por nosotros como defectuosas son reemplazadas, sin ninguna clase de compensación.</p>
Reclamaciones	<p>Toda reclamación deberá llegarnos en un plazo máximo de 2 semanas después de recibir la mercancía.</p>
Planos y croquis	<p>Nuestros planos, croquis y otros documentos presentados no pueden ser reproducidos, copiados, transmitidos o cedidos a terceros. Debido a la evolución técnica y a una eventual entrada en vigor de nuevas normas, las indicaciones que figuren en nuestros catálogos, planos y croquis pueden sufrir modificaciones y son por lo tanto hechas sin compromiso.</p>
Condiciones especiales	<p>En caso de fuerza mayor, interrupción parcial o total de nuestra explotación, nos reconocemos el derecho a rescindir todos o parte de nuestros compromisos de entrega.</p>
Jurisdicción	<p>Los litigios se someten a la justicia suiza y la jurisdicción de la cual dependen es Moutier (Suiza).</p>

DELIVERY AND PAYMENT CONDITIONS

Orders	Orders, which cannot be delivered from stock, will be acknowledged. Items, which do not belong any more to our standard programme, although still featured in the catalogue, will be invoiced as «specials». Orders may only be cancelled by mutual written agreement.
Quotations and acknowledgements	For reasons of constant development in this field, all descriptions mentioned in our quotations, annexed documents, weight indications, measurements as well as illustrations and drawings are approximate indications. These technical data have binding value only if expressly specified.
Prices	Our prices are quoted for deliveries ex works Malleray, excluding VAT, packing, insurance, freight, customs' and legalisation duties. Should prices increase, we reserve the right to invoice tools already acknowledged at the new prices.
Payment	Payments must be made in advance or against irrevocable and confirmed documentary credit to be opened in our favour with a Swiss bank. All banking commissions and charges have to be borne by the buyer.
Right of ownership	We reserve the right of ownership of all goods supplied until the sales price, plus all incidental charges, have fully been paid.
Despatch	Deliveries take place at the purchaser's risk.
Delivery	Confirmed delivery dates are non-binding. We will do our utmost to maintain them. However, we cannot accept responsibility of direct or consequential losses due to delayed deliveries.
Special orders	For all special tools we reserve the right to over or under supply the ordered quantity by up to 15 %, or on small quantities by 1 or 2 pieces.
Guarantee	Tools recognised to be defective by DC will be replaced free of charge, but without prejudice.
Complaints	Complaints will be considered only within 15 days after receipt of the goods.
Drawings and sketches	The reproduction or transmission of drawings and other documents to a third party are prohibited. The information (drawings and prints) in our catalogue is for guidance only and is not binding.
Special conditions	In the case of partial or total disruption of our production; we reserve the right to partially or totally cancel our delivery commitments.
Tribunal	All disputes are subject to Swiss Law. The seat of court of law will be Moutier (Switzerland).

DC PROGRAMME OVERVIEW

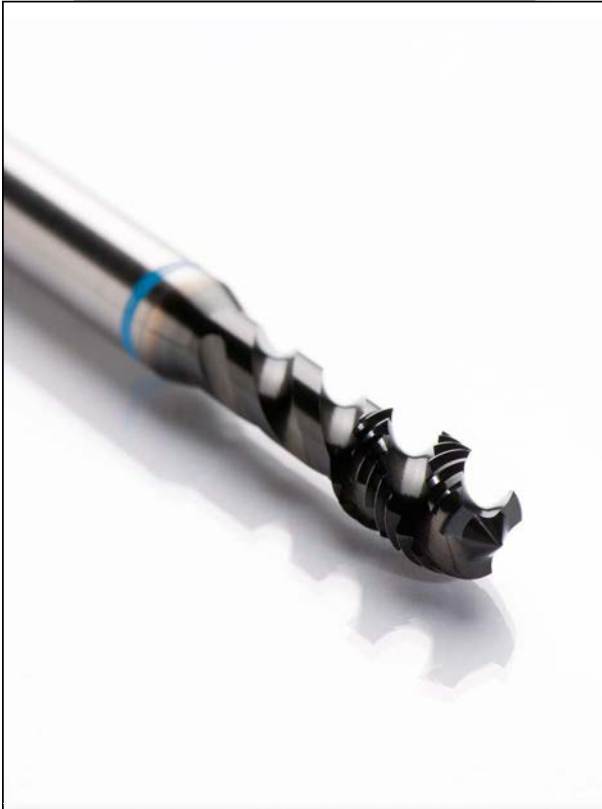

THREAD CUTTING

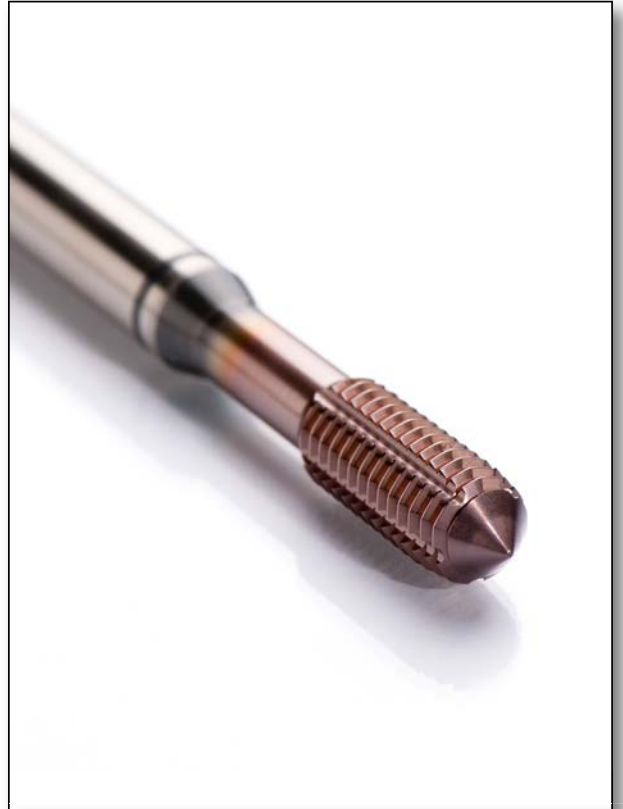

THREAD FORMING



RIGID TAPPING



TAPPING CHUCKS

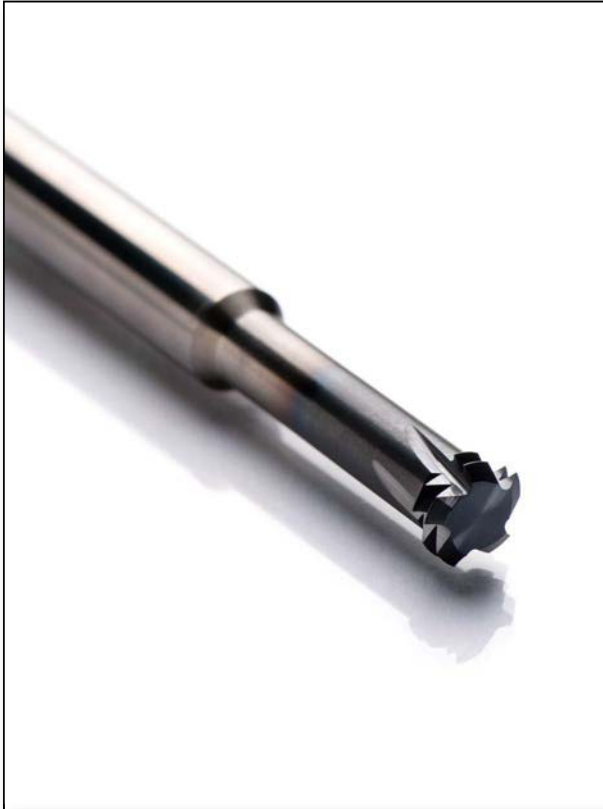

THREAD WHIRLING



THREAD MILLING



THREAD DIES



THREAD GAUGES

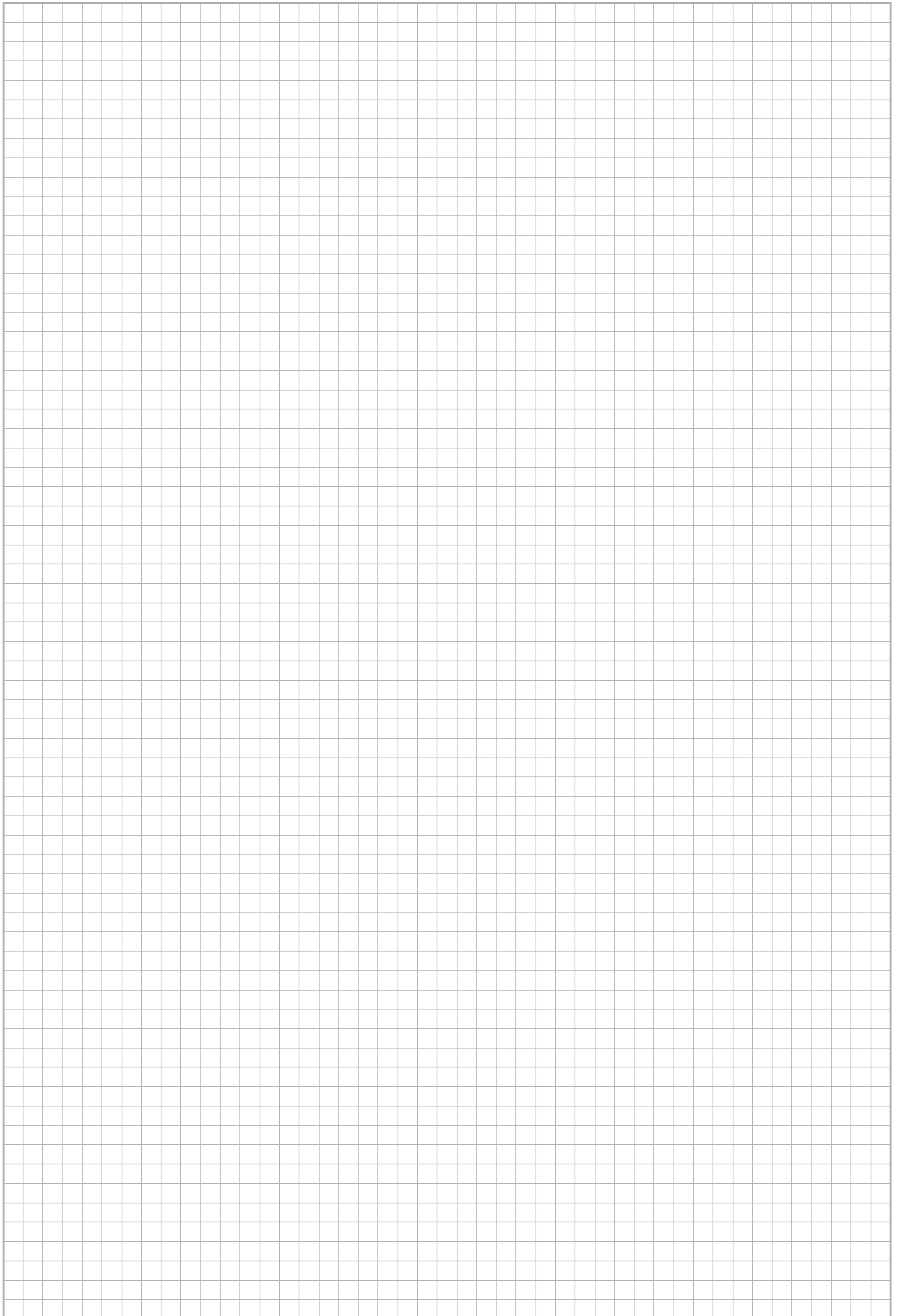

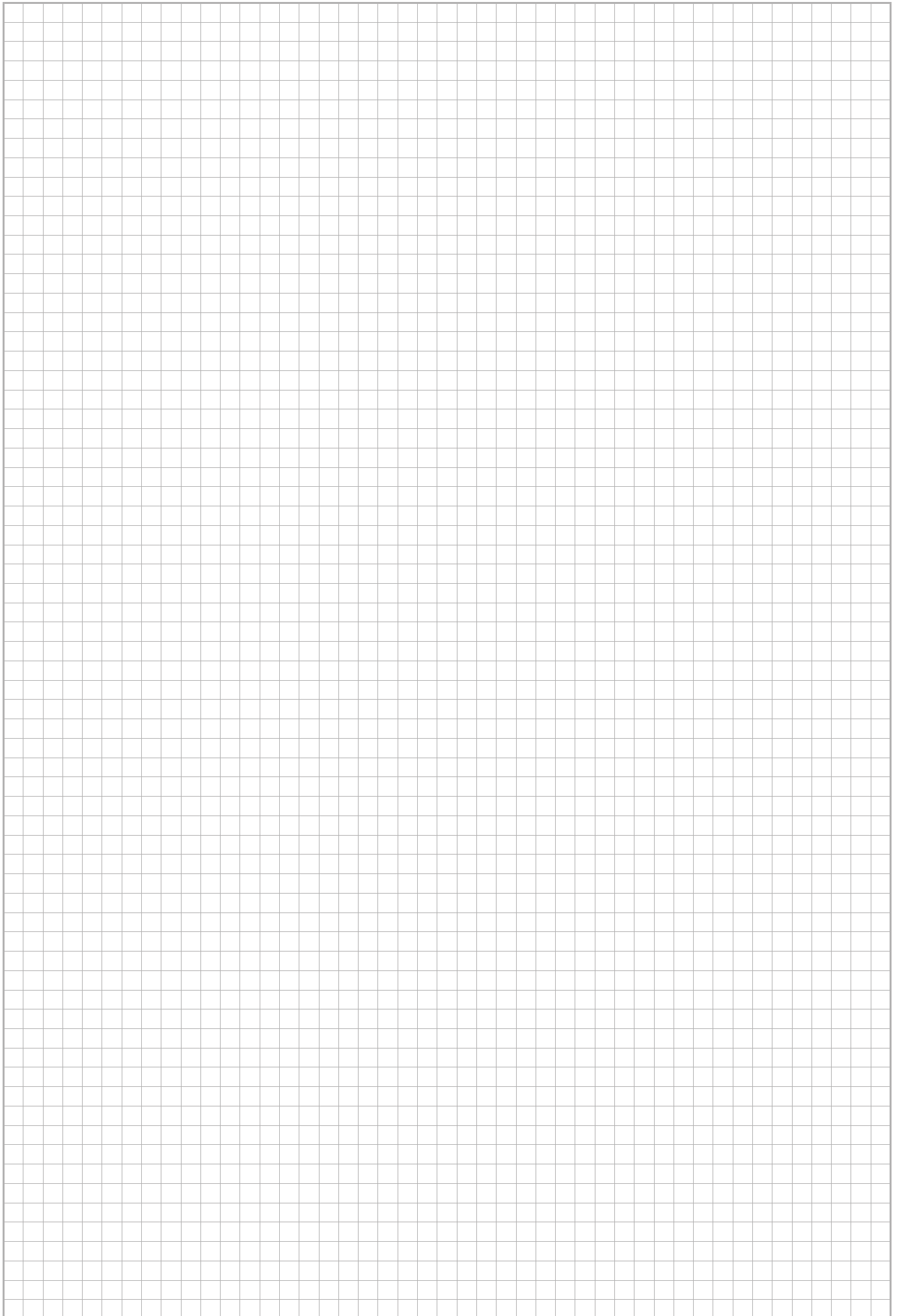



DC SWISS SA
Grand-Rue 19
CH-2735 Malleray
Tel. + 41 32 491 63 63
info@dcswiss.ch



DC Nano Tools SA
Grand-Rue 19
CH-2735 Malleray
Tel. + 41 32 491 63 63
info@dcswiss.ch

DC Swiss GmbH
Graseggerstrasse 125
DE-50737 Köln
Tel. + 49 221 995 532 0
info@dcswiss.de

DC Swiss s.r.l
Via Canova 10
IT-20017 Rho
Tel. + 39 02 669 40 41
info@dcswiss.it

DC Swiss UK Ltd
9 Orgreave Road
GB-Sheffield S13 9LQ
Tel. + 44 114 293 90 13
info@dcswiss.co.uk

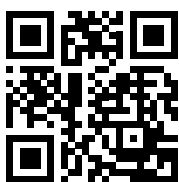

dcswiss.com



ATENCIÓN

Un problema técnico o una negligencia pueden ser el origen que un herramienta se rompa parcial o totalmente, pudiendo afectar a la integridad física del operario. Es de obligado cumplimiento seguir escrupulosamente las normativas de seguridad y de salud de las empresas activas en el tratamiento de los metales. El uso de gafas de protección es indispensable. El reafilado de útiles de roscado provoca partículas peligrosas para la salud y debe ser ejecutado según las instrucciones de seguridad necesarias.

WARNING

Thread tools can break or shatter either through technical failure or negligence, and can endanger the health of the operator. Always obey the safety and health regulations, also the wearing of safety glasses is compulsory. The grinding of threading tools causes hazardous particles, and must be performed only under most rigorous safety standards.

Eventuales cambios de los datos técnicos, modificaciones de toda índole, errores de impresión, no dan en modo alguno derecho a indemnizaciones. Las reproducciones de textos, imágenes o extractos están prohibidas.

We have made every effort to ensure that the information (drawings, prints, technical data) given is correct. However, we do not assume any responsibility for any errors, omissions or subsequent changes. The reproduction of drawings and other documents and their transmission to a third party is prohibited.

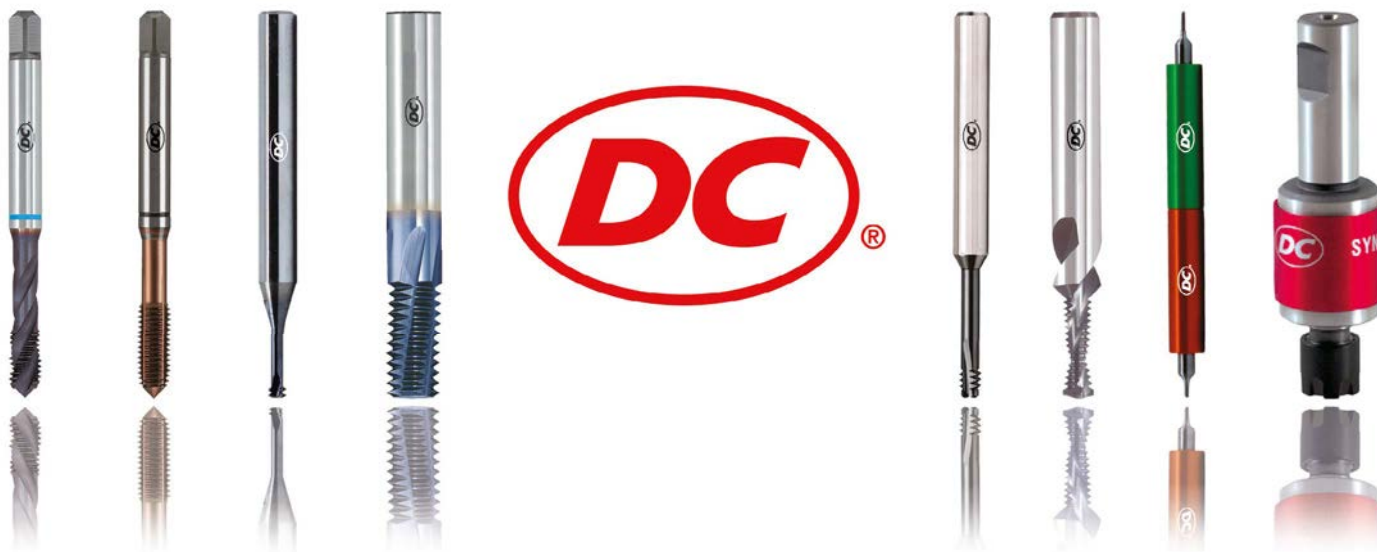

DC SWISS SA
 Grand-Rue 19
 CH-2735 Malleray
 Tel. + 41 32 491 63 63
 info@dcswiss.ch

DC Nano Tools SA
 Grand-Rue 19
 CH-2735 Malleray
 Tel. + 41 32 491 63 63
 info@dcswiss.ch



DC Swiss GmbH
 Graseggerstrasse 125
 DE-50737 Köln
 Tel. + 49 221 995 532 0
 info@dcswiss.de

DC Swiss s.r.l
 Via Canova 10
 IT-20017 Rho
 Tel. + 39 02 669 40 41
 info@dcswiss.it

DC Swiss UK Ltd
 9 Orgreave Road
 GB-Sheffield S13 9LQ
 Tel. + 44 114 293 90 13
 info@dcswiss.co.uk